

SIEMENS

Ingenuity for life

June 2016



SIMATIC Ident Configuration Guide

Unrestricted © Siemens AG 2016. Alle Rechte vorbehalten



siemens.com/ident





Content





Select and configure a SIMATIC RF Family	3
RF200	
Family Matrix	4
System Interfaces	12
RF300	
Family Matrix	16
System Interfaces	24
MOBY D	
Family Matrix	27
System Interfaces	29
RF600	
Family Matrix	33
System Interfaces	38
RF Handheld Reader	42
RF Software DVD	44
RF-DIAG	45
Configure an Optical Identification System	
MV400	
Lens configurator	46
System Interfaces MV420	48
System Interfaces MV440	52
MV300 System Interfaces	57
Bill of Materials Guide	
ASM 456.....	58
RF160C.....	59
RF180C.....	60
RF182C.....	61
RFID 181EIP	62
Bulk Cable and Connectors	63

Each SIMATIC RF Family has characteristics that orients it to a particular range of applications:





- The first step is to understand the application by asking the right questions. Out of this process, the best-suited SIMATIC RF family can be determined
- A reader and tag combination within the specific family can be selected using the SIMATIC RF family matrix pages
- Within the chosen family, a network interface to the control system can be selected using the system interfaces pages





Technology	HF		UHF	
<i>How far away can the tag be from the reader antenna system and still be seen?</i>	RF200  13.56 MHz Passive	RF300  13.56 MHz Passive	MOBY D  13.56 MHz Passive	RF600  868/915 MHz Passive





Environment	Lighter		Heavier	
<i>What kind of environmental extremes will the tags be subjected to?</i>	MOBY D  220° C IP68	RF200  220° C IP68	RF300  220° C IP68	RF600  230° C IP68





Read Distance	Shorter		Longer	
<i>How far away can the tag be from the reader antenna system and still be seen?</i>	RF300  210 mm	MOBY D  380 mm	RF200  650 mm	RF600  8 meters





Reader Dimensions	Smallest		Largest	
<i>How much space will there be for mounting the reader/ antenna?</i>	RF200  M8 x 38	RF300  M12 x 40	RF600  75 x 75 x 20	MOBY D  160 x 80 x 40





Tag Memory	Less		More	
<i>How many bytes are required to be stored on the tag?</i>	MOBY D  2 kbytes	RF600  4 kbytes	RF200  8 kbytes	RF300  64 kbyte





















Multitag Mode	Less		More	
<i>Will there be more than one tag in the RF field at a time?</i>	RF200  1	RF300  1	MOBY D  30+	RF600  100+

Metal Effects	Direct Mount		Spacer Mount	
<i>Do tags and reader need to be mounted on or around metal?</i>	RF300  Direct with reduction	RF600  Direct with reduction	RF200  Spacer mount	MOBY D  Spacer mount

Tag Speed	Slower		Faster	
<i>How fast will the tag be traveling through the RF field?</i>	RF200  26 kbits/sec	MOBY D  26 kbits/sec	RF300  100 kbits/sec	RF600  300 kbits/sec

















Tag Dimensions	Smallest		Largest	
<i>What is the smallest tag size available?</i>	RF200  Ø 4 x 5 mm	RF300  Ø 6 x 5 mm	MOBY D  Ø16 x 3 mm	RF600  Ø 21 x 20 mm

Air Interface Protocol	Siemens		Standard	
<i>Are there any requirements regarding the air interface protocol?</i>	RF300  Siemens/ ISO15693	MOBY D  ISO 15693	RF200  ISO 15693	RF600  ISO 18000 -6B/ -6C

RF200 Family Matrix 13.56 MHz Passive Tags Operational temperature range Dimensions (L x W x D) mm Ingress Protection (IP) rating	Antennas	D165 6GT2 600-1AB00-0AX0 112 byte EEPROM  -25°C to 85°C 86 x 54 x 0,3 IP65	D261 6GT2 600-1AA01-0AX0 256 byte EEPROM  -25°C to 85°C 55 x 55 x 0,3 IP65	D100 6GT2 600-0AD10 112 byte EEPROM  -25°C to 80°C 85,6 x 54 x 0,9 IP68	D200 6GT2 600-1AD00 -0AX0 256 byte EEPROM  -20°C to 60°C 85,6 x 54 x 0,8 IP67	D400 6GT2 600-4AD00 2 kbyte FRAM  -20°C to 60°C 85,6 x 54 x 0,8 IP67	D160 6GT2 600-0AB10 112 byte EEPROM  -40°C to 175°C Ø 16 x 3 IP68/IPx9K	D460 6GT2 600-4AB00 2 kbyte FRAM  -40°C to 100°C Ø 16 x 3 IP67/IPx9K
RF210R/ RF210M 6GT2 821-1AC10, RS422 6GT2 821-1AC32, IO-Link 6GT2 823-0AA00, Handheld (RS422) 	Integrated M18 x 71						1-10/ 12 (0.04-0.39/ 0.47)	1-8/ 9 (0.04-0.31/ 0.35)
RF220R 6GT2 821-2AC10, RS422 6GT2 821-2AC32, IO-Link 	Integrated M30 x 71						1-20/ 22 (0.04-0.79/ 0.87)	1-18/ 20 (0.04-0.71/ 0.79)
RF240R 6GT2 821-4AC10, RS422 6GT2 821-4AC40, RS232 (ASCII) 6GT2821-4AC32, IO-Link 	Integrated 50 x 50 x 30	2-80/ 94 (0.08-3.15/ 3.70)	2-60/ 70 (0.08-2.36/ 2.76)	2-84/ 95 (0.08-3.31/ 3.74)	2-69/ 78 (0.08-2.72/ 3.07)	2-80/ 90 (0.08-3.72/ 3.54)	1-33/ 37 (0.04-1.30/ 1.46)	1-30/ 34 (0.04-1.18/ 1.34)
RF250R ANT 1 6GT2 821-5AC10, RS422 6GT2 821-5AC40, RS232 (ASCII) 6GT2821-5AC32, IO-Link 6GT2 398-1CB00, ANT 1 	 75 x 75 x 20							
RF250R ANT 3 6GT2 821-5AC10, RS422 6GT2 821-5AC40, RS232 (ASCII) 6GT2821-5AC32, IO-Link 6GT2 398-1CD40-0AX0, ANT 3 	 28 x 50 x 10						1-16/ 20 (0.04-0.63/ 0.79)	0-18/ 25 (0-0.71/ 0.98)
RF250R ANT 3S 6GT2 821-5AC10, RS422 6GT2 821-5AC40, RS232 (ASCII) 6GT2821-5AC32, IO-Link 6GT2 398-1CD60-0AX0, ANT 3S 	 28 x 50 x 10							
RF250R ANT 8 6GT2 821-5AC10, RS422 6GT2 821-5AC40, RS232 (ASCII) 6GT2821-5AC32, IO-Link 6GT2 398-1CF10, ANT 8 	 Ø8 x 40							
RF250R ANT 12 6GT2 821-5AC10, RS422 6GT2 821-5AC40, RS232 (ASCII) 6GT2821-5AC32, IO-Link 6GT2 398-1CC00, ANT 12 	 Ø12 x 40						0-12/ 17 (0-0.47/0.67)	1-10/ 14 (0.04-0.39/0.55)
Accessories				Holder (6GT2 390-0AA00) 20 mm spacer (6GT2 190-0AA00) Fixing pocket (6GT2 190-0AB00)	Holder (6GT2 390-0AA00) 20 mm spacer (6GT2 190-0AA00) Fixing pocket (6GT2 190-0AB00)	Holder (6GT2 390-0AA00) 20 mm spacer (6GT2 190-0AA00) Fixing pocket (6GT2 190-0AB00)	Spacer (6GT2 690-0AG00)	Spacer (6GT2 690-0AG00)



















Operating Distance Range (mm) / Maximum Distance for Stationary Tag (mm)

Operating Distance Range (inch) / Maximum Distance for Stationary Tag (inch)

RF200 Family Matrix 13.56 MHz Passive Tags Operational temperature range Dimensions (L x W x D) mm Ingress Protection (IP) rating	Antennas	D165 6GT2 600-1AB00-0AX0 112 byte EEPROM  -25°C to 85°C 86 x 54 x 0,3 IP65	D261 6GT2 600-1AA01-0AX0 256 byte EEPROM  -25°C to 85°C 55 x 55 x 0,3 IP65	D100 6GT2 600-0AD10 112 byte EEPROM  -25°C to 80°C 85,6 x 54 x 0,9 IP68	D200 6GT2 600-1AD00 -0AX0 256 byte EEPROM  -20°C to 60°C 85,6 x 54 x 0,8 IP67	D400 6GT2 600-4AD00 2 kbyte FRAM  -20°C to 60°C 85,6 x 54 x 0,8 IP67	D160 6GT2 600-0AB10 112 byte EEPROM  -40°C to 175°C Ø 16 x 3 IP68/IPx9K	D460 6GT2 600-4AB00 2 kbyte FRAM  -40°C to 100°C Ø 16 x 3 IP67/IPx9K
RF250R ANT 18 6GT2 821-5AC10, RS422 6GT2 821-5AC40, RS232 (ASCII) 6GT2821-5AC32, IO-Link 6GT2 398-1CA00, ANT 18 	 Ø18 x 55						1-18/ 26 (0.04-0.71/ 1.02)	1-17/ 21 (0.04-0.47/ 0.83)
RF250R ANT 30 6GT2 821-5AC10, RS422 6GT2 821-5AC40, RS232 (ASCII) 6GT2821-5AC32, IO-Link 6GT2 398-1CD00, ANT 30 	 Ø30 x 58						1-23/ 30 (0.04-0.91/ 1.18)	1-21/ 27 (0.04-0.83/ 1.06)
RF260R 6GT2 821-6AC10, RS422 6GT2 821-6AC40, RS232 (ASCII) 6GT2 821-6AC32, IO-Link 	Integrated 75 x 75 x 41	2-120/ 135 (0.08-4.72/ 5.31)	2-75/ 90 (0.08-2.95/ 3.54)	2-110/ 130 (0.08-4.33/ 5.51)	2-100/ 120 (1.18-3.94/ 4.72)	2-110/ 140 (0.08-4.33/ 5.51)	2-40/ 45 (0.08-1.57/ 1.77)	2-40/45 (0.08-1.57/ 1.77)
RF290R 6GT2 821-0AC12, RS232, RS422  Accessory: Set for top rail mounting 6GK5798-8ML00-0AB3	ANT D1  6GT2 698-5AC00 75 x 75 x 20	10-180/ 250 (0.39-7.09/ 9.84)		10-180/ 250 (0.39-7.09/ 9.84)	10-170/240 (0.39-6.69/ 9.45)	10-170/240 (0.39-6.69/ 9.45)	0-65/90 (0-2.56/ 3.54)	0-60/85 (0-2.36/ 3.35)
	ANT D5  6GT2 698-5AA10 380 x 380 x 110	0-350/ 450 (0-13.78/ 17.72)	0-300/ 400 (0-11.81 / 15.75)	0-400/ 500 (0-15.75/ 19.69)	0-400/ 500 (0-15.75/ 19.69)	0-400/ 500 (0-15.75/ 19.69)	0-130/ 180 (0-5.12/ 7.09)	0-120/ 160 (0-4.72/ 6.30)
	ANT D6  6GT2 698-5AB00 580 x 480 x 110	0-400/ 500 (0-15.75/ 19.69)	0-350/ 450 (0-13.78 / 17.72)	0-550/ 650 (0-21.65/ 25.59)	0-500/ 600 (0-19.69/ 23.62)	0-500/ 650 (0-19.69/ 25.59)	0- 130/ 180 (0-5.12/ 7.09)	
	ANT D10  6GT2 698-5AF00 1150 x 365 x 115	0-350/ 450 (0-13.78/ 17.72)	0-350/ 450 (0-13.78 / 17.72)	0-500/ 600 (0-19.69/ 23.62)	0-450/ 550 (0-17.72/ 21.62)	0-400/ 500 (0-15.75/ 19.69)	0- 130/ 180 (0-5.12/ 7.09)	
Accessories	Covering hood for ANT D6 (6GT2 690-0AD00)			Holder (6GT2 390-0AA00) 20 mm spacer (6GT2 190-0AA00) Fixing pocket (6GT2 190-0AB00)	Holder (6GT2 390-0AA00) 20 mm spacer (6GT2 190-0AA00) Fixing pocket (6GT2 190-0AB00)	Holder (6GT2 390-0AA00) 20 mm spacer (6GT2 190-0AA00) Fixing pocket (6GT2 190-0AB00)	Spacer (6GT2 690-0AG00)	Spacer (6GT2 690-0AG00)

Operating Distance Range (mm) / Maximum Distance for Stationary Tag (mm)

















Operating Distance Range (inch) / Maximum Distance for Stationary Tag (inch)

RF200 Family Matrix 13.56 MHz Passive Tags Operational temperature range Dimensions (L x W x D) mm Ingress Protection (IP) rating	Antennas	D117 6GT2 600-0AG00 112 byte EEPROM  -40°C to 125°C Ø4 x 5 IP68	D127 6GT2 600-0AF00 112 byte EEPROM  -40°C to 125°C Ø 6 x 6 IP68/ IPx9K	D421 6GT2 600-4AE00 2 kbyte FRAM  -40°C to 100°C Ø10 x 4,5 IP67/ IPx9K	D521* 6GT2 600-5AE00 8 kbyte FRAM  -40°C to 100°C Ø10 x 4,5 IP67/ IPx9K	D422 6GT2 600-4AF00 2 kbyte FRAM  -40°C to 100°C Ø20 x 6 IP68	D522* 6GT2600-5AF00 6GT2600-5AF00-0AX0 8 kbyte FRAM  -40°C to 100°C Ø20 x 6 ; Ø18 x 5,2 IP68
RF210R/ RF210M 6GT2 821-1AC10, RS422 6GT2 821-1AC32, IO-Link 6GT2 823-0AA00, Handheld (RS422) 	Integrated M18 x 71		0-2/ 2 (0-0.08/ 0.08)	0-3/ 4 (0.0-0.12/ 0.16)	0-3/ 4 (0-0.12/ 0.16)	1-9/ 10 (0.04-0.35/ 0.39)	1-8/ 9 (0.04-0.31/ 0.35)
RF220R 6GT2 821-2AC10, RS422 6GT2 821-2AC32, IO-Link 	Integrated M30 x 71					1-12/ 14 (0.04-0.47/ 0.55)	1-10/ 12 (0.04-0.39/ 0.47)
RF240R 6GT2 821-4AC10, RS422 6GT2 821-4AC40, RS232 (ASCII) 6GT2821-4AC32, IO-Link 	Integrated 50 x 50 x 30					1-12/ 15 (0.04-0.47/ 0.59)	1-10/ 12 (0.04-0.39/ 0.47)
RF250R ANT 1 6GT2 821-5AC10, RS422 6GT2 821-5AC40, RS232 (ASCII) 6GT2821-5AC32, IO-Link 6GT2 398-1CB00, ANT 1 	 75 x 75 x 20						
RF250R ANT 3 6GT2 821-5AC10, RS422 6GT2 821-5AC40, RS232 (ASCII) 6GT2821-5AC32, IO-Link 6GT2 398-1CD40-0AX0, ANT 3 	 28 x 50 x 10					1-12/ 15 (0.04-0.47/ 0.59)	1-12/ 15 (0.04-0.47/ 0.59)
RF250R ANT 3S 6GT2 821-5AC10, RS422 6GT2 821-5AC40, RS232 (ASCII) 6GT2821-5AC32, IO-Link 6GT2 398-1CD60-0AX0, ANT 3S 	 28 x 50 x 10	0-2/ 3 (0-0.08/ 0.12)	0-2/ 3 (0-0.08/ 0.12)	0-3/ 4 (0-0.12/ 0.16)	0-3/ 4 (0-0.12/ 0.16)		
RF250R ANT 8 6GT2 821-5AC10, RS422 6GT2 821-5AC40, RS232 (ASCII) 6GT2821-5AC32, IO-Link 6GT2 398-1CF10, ANT 8 	 Ø8 x 40	0-2/ 3 (0-0.08/ 0.12)	0-3/ 4 (0-0.12/ 0.16)	0-3/ 4 (0-0.12/ 0.16)	0-3/ 4 (0-0.12/ 0.16)		
RF250R ANT 12 6GT2 821-5AC10, RS422 6GT2 821-5AC40, RS232 (ASCII) 6GT2821-5AC32, IO-Link 6GT2 398-1CC00, ANT 12 	 Ø12 x 40	0-3/ 4 (0-0.12/ 0.16)	0-4/ 5 (0-0.15/ 0.20)	0-3/ 4 (0-0.12/ 0.16)	0-3/ 4 (0-0.12/ 0.16)	0-7/ 10 (0-0.28/ 0.39)	1-7/ 9 (0.04-0.28/ 0.35)
Accessories							

Operating Distance Range (mm) / Maximum Distance for Stationary Tag (mm)

Operating Distance Range (inch) / Maximum Distance for Stationary Tag (inch)





















*compatible only with the RS422 variant of the readers.

RF200 Family Matrix 13.56 MHz Passive Tags Operational temperature range Dimensions (L x W x D) mm Ingress Protection (IP) rating	Antennas	D117 6GT2 600-0AG00 112 byte EEPROM  -40°C to 125°C Ø4 x 5 IP68	D127 6GT2 600-0AF00 112 byte EEPROM  -40°C to 125°C Ø 6 x 6 IP68/ IPx9K	D421 6GT2 600-4AE00 2 kbyte FRAM  -40°C to 100°C Ø10 x 4,5 IP67/ IPx9K	D521* 6GT2 600-5AE00 8 kbyte FRAM  -40°C to 100°C Ø10 x 4,5 IP67/ IPx9K	D422 6GT2 600-4AF00 2 kbyte FRAM  -40°C to 100°C Ø20 x 6 IP68	D522* 6GT2600-5AF00 6GT2600-5AF00-0AX0 8 kbyte FRAM  -40°C to 100°C Ø20 x 6 ; Ø18 x 5,2 IP68
RF250R ANT 18 6GT2 821-5AC10, RS422 6GT2 821-5AC40, RS232 (ASCII) 6GT2821-5AC32, IO-Link 6GT2 398-1CA00, ANT 18	  Ø18 x 55			0-3/ 5 (0-0.12/ 0.20)	0-4/ 5 (0-0.16/ 0.20)	1-8/ 14 (0.04-0.31/ 0.55)	1-10/ 12 (0.04-0.39/ 0.47)
RF250R ANT 30 6GT2 821-5AC10, RS422 6GT2 821-5AC40, RS232 (ASCII) 6GT2821-5AC32, IO-Link 6GT2 398-1CD00, ANT 30	  Ø30 x 58					0-12/ 15 (0-0.47/ 0.59)	1-12/ 15 (0.04-0.47/ 0.59)
RF260R 6GT2 821-6AC10, RS422 6GT2 821-6AC40, RS232 (ASCII) 6GT2 821-6AC32, IO-Link	 Integrated 75 x 75 x 41						
RF290R 6GT2 821-0AC12, RS232, RS422  Accessory: Set for top rail mounting 6GK5798-8ML00-0AB3	ANT D1  6GT2 698-5AC00 75 x 75 x 20						20-25/ 35 (0.79-0.98/ 1.38)
	ANT D5  6GT2 698-5AA10 380 x 380 x 110						
	ANT D6  6GT2 698-5AB00 580 x 480 x 110						
	ANT D10  6GT2 698-5AF00 1150 x 365 x 115						
Accessories	Covering hood for ANT D6 (6GT2 690-0AD00)						

Operating Distance Range (mm) / Maximum Distance for Stationary Tag (mm)

Operating Distance Range (inch) / Maximum Distance for Stationary Tag (inch)

















*compatible only with the RS422 variant of the readers.

RF200 Family Matrix 13.56 MHz Passive Tags Operational temperature range Dimensions (L x W x D) mm Ingress Protection (IP) rating	Antennas	D124 6GT2 600-0AC10 112 byte EEPROM  -40°C to 180°C Ø 27 x 4 IP68/ IPx9K	D324 6GT2 600-3AC00 992 byte EEPROM  -40°C to 140°C Ø 27 x 4 IP67	D424 6GT2 600-4AC00 2 kbyte FRAM  -40°C to 100°C Ø 27 x 4 IP67/ IPx9K	D524* 6GT2 600-5AC00 8 kbyte FRAM  -40°C to 100°C Ø 27 x 4 IP67/ IPx9K	D126 6GT2 600-0AE00 112 byte EEPROM  -40°C to 100°C Ø 50 x 3,6 IP68	D426 6GT2 600-4AH00 2 kbyte FRAM  -40°C to 100°C Ø 50 x 3,6 IP68	D526* 6GT2 600-5AH00 8 kbyte FRAM  -40°C to 100°C Ø 50 x 3,6 IP68
RF210R/ RF210M 6GT2 821-1AC10, RS422 6GT2 821-1AC32, IO-Link 6GT2 823-0AA00, Handheld (RS422) 	Integrated M18 x 71	1-18/ 20 (0.04-0.63/ 0.79)	1-8/ 9 (0.04-0.31/ 0.35)	1-16/ 18 (0.04-0.63/ 0.71)	1-15/ 17 (0.04-0.59/ 0.67)			
RF220R 6GT2 821-2AC10, RS422 6GT2 821-2AC32, IO-Link 	Integrated M30 x 71	1-28/ 31 (0.04-1.10/ 1.22)	2-21/ 25 (0.08-0.83/ 0.98)	2-25/ 29 (0.08-0.98/ 1.14)	2-25/ 25 (0.08-0.98/ 0.98)	2-30/ 35 (0.08-1.18/ 1.38)	2-25/ 30 (0.08-0.98/ 1.18)	2-25/ 30 (0.08-0.98/ 1.18)
RF240R 6GT2 821-4AC10, RS422 6GT2 821-4AC40, RS232 (ASCII) 6GT2821-4AC32, IO-Link 	Integrated 50 x 50 x 30	2-53/ 60 (0.08-2.09/ 2.36)	1-36/ 40 (0.04-1.42/ 1.57)	1-47/ 53 (0.04-1.85/ 2.09)	1-45/ 55 (0.04-1.77/ 2.17)	2-57/ 65 (0.08-2.24/ 2.56)	2-45/ 55 (0.08-1.77/ 2.17)	2-45/ 55 (0.08-1.77/ 2.17)
RF250R ANT 1 6GT2 821-5AC10, RS422 6GT2 821-5AC40, RS232 (ASCII) 6GT2821-5AC32, IO-Link 6GT2 398-1CB00, ANT 1 	 75 x 75 x 20				1-65/ 85 (0.04-2.56/ 3.35)			2-75/ 90 (0.08-2.95/ 3.54)
RF250R ANT 3 6GT2 821-5AC10, RS422 6GT2 821-5AC40, RS232 (ASCII) 6GT2821-5AC32, IO-Link 6GT2 398-1CD40-0AX0, ANT 3 	 28 x 50 x 10	2-32/ 40 (0.08-1.26/ 1.57)	2-32/ 40 (0.08-1.26/ 1.57)	0-45/ 50 (0-1.77/ 1.97)	1-30/ 40 (0.04-1.18/ 1.57)			
RF250R ANT 3S 6GT2 821-5AC10, RS422 6GT2 821-5AC40, RS232 (ASCII) 6GT2821-5AC32, IO-Link 6GT2 398-1CD60-0AX0, ANT 3S 	 28 x 50 x 10							
RF250R ANT 8 6GT2 821-5AC10, RS422 6GT2 821-5AC40, RS232 (ASCII) 6GT2821-5AC32, IO-Link 6GT2 398-1CF10, ANT 8 	 Ø8 x 40							
RF250R ANT 12 6GT2 821-5AC10, RS422 6GT2 821-5AC40, RS232 (ASCII) 6GT2821-5AC32, IO-Link 6GT2 398-1CC00, ANT 12 	 Ø12 x 40		0-10/ 13 (0-0.39/ 0.51)					
Accessories		Spacer (6GT2 690-0AK00)	Spacer (6GT2 690-0AK00)	Spacer (6GT2 690-0AK00)	Spacer (6GT2 690-0AK00)	Spacer (6GT2 690-0AL00)	Spacer (6GT2 690-0AL00)	Spacer (6GT2 690-0AL00)

Operating Distance Range (mm) / Maximum Distance for Stationary Tag (mm)

Operating Distance Range (inch) / Maximum Distance for Stationary Tag (inch)





















*compatible only with the RS422 variant of the readers.

RF200 Family Matrix 13.56 MHz Passive Tags Operational temperature range Dimensions (L x W x D) mm Ingress Protection (IP) rating	Antennas	D124 6GT2 600-0AC10 112 byte EEPROM  -40°C to 180°C Ø 27 x 4 IP68/ IPx9K	D324 6GT2 600-3AC00 992 byte EEPROM  -40°C to 140°C Ø 27 x 4 IP67	D424 6GT2 600-4AC00 2 kbyte FRAM  -40°C to 100°C Ø 27 x 4 IP67/ IPx9K	D524* 6GT2 600-5AC00 8 kbyte FRAM  -40°C to 100°C Ø 27 x 4 IP67/ IPx9K	D126 6GT2 600-0AE00 112 byte EEPROM  -40°C to 100°C Ø 50 x 3,6 IP68	D426 6GT2 600-4AH00 2 kbyte FRAM  -40°C to 100°C Ø 50 x 3,6 IP68	D526* 6GT2 600-5AH00 8 kbyte FRAM  -40°C to 100°C Ø 50 x 3,6 IP68
RF250R ANT 18 6GT2 821-5AC10, RS422 6GT2 821-5AC40, RS232 (ASCII) 6GT2821-5AC32, IO-Link 6GT2 398-1CA00, ANT 18 	 Ø18 x 55	0-24/ 37 (0.0-94/ 1.46)	1-18/ 27 (0.04-0.71/ 1.06)	1-27/ 36 (0.04-1.06/ 1.42)	1-25/ 30 (0.04-0.98/ 1.18)			
RF250R ANT 30 6GT2 821-5AC10, RS422 6GT2 821-5AC40, RS232 (ASCII) 6GT2821-5AC32, IO-Link 6GT2 398-1CD00, ANT 30 	 Ø30 x 58	1-35/ 48 (0.08-1.38/ 1.89)	1-22/ 35 (0.04-0.87/ 1.38)	0-34/ 48 (0-1.34/ 1.89)	1-35/ 40 (0.04-1.38/ 1.57)	0-47/ 60 (0-1.85/ 2.36)	0-44/ 58 0-1.73/ 2.28)	2-35/ 45 (0.08-1.38/ 1.77)
RF260R 6GT2 821-6AC10, RS422 6GT2 821-6AC40, RS232 (ASCII) 6GT2 821-6AC32, IO-Link 	Integrated 75 x 75 x 41	2-80/ 85 (0.08-3.15/ 3.35)	2-60/ 70 (0.08-2.36/ 2.76)	2-60/ 70 (0.08-2.36/ 2.76)	2-60/ 70 (0.08-2.36/ 2.76)	2-75/ 100 (0.08-2.95/ 3.94)	2-70/ 85 (0.08-2.76/ 3.35)	2-70/ 85 (0.08-2.76/ 3.35)
RF290R 6GT2 821-0AC12, RS232, RS422  Accessory: Set for top rail mounting 6GK5798-8ML00-0AB3	ANT D1  6GT2 698-5AC00 75 x 75 x 20	0-100/ 140 (0-3.94/ 5.51)	0-90/ 130 (0-3.54/ 5.12)	0-90/ 130 (0-3.54/ 5.12)	0-90/ 130 (0.00-3.54/ 5.12)	5-110/150 (0.20-4.34/ 5.91)	5-100/ 140 (0.20-3.94/ 5.51)	5-100/ 140 (0.20-3.94/ 5.51)
	ANT D5  6GT2 698-5AA10 380 x 380 x 110	0-200/ 280 (0-7.87/ 11)	0-200/ 280 (0-7.87/ 11)	0-200/ 280 (0-7.87/ 11)	0-200/ 280 (0-7.87/ 11)	0-350/ 400 (0-13.78/ 15.75)	0-300/ 350 (0-11.81/ 13.78)	0-300/ 350 (0-11.81/ 13.78)
	ANT D6  6GT2 698-5AB00 580 x 480 x 110	0-220/ 300 (0-8.66/ 11.81)	0-200/ 280 (0-7.87/ 11)	0-220/ 300 (0-8.66/ 11.81)	0-220/ 300 (0-8.66/ 11.81)	0-400/ 500 (0-15.75/ 19.69)	0-350/ 400 (0-13.78/ 15.75)	0-350/ 400 (0-13.78/ 15.75)
	ANT D10  6GT2 698-5AF00 1150 x 365 x 115	0-200/ 280 (0-7.87/ 11)	0-200/ 280 (0-7.87/ 11)	0-200/ 280 (0-7.87/ 11)	0-220/ 300 (0-8.66/ 11.81)	0-400/ 500 (0-9.41/ 13.78)	0-350/ 400 (0-13.78/ 15.75)	0-350/ 400 (0-13.78/ 15.75)
Accessories	Covering hood for ANT D6 (6GT2 690-0AD00)	Spacer (6GT2 690-0AK00)	Spacer (6GT2 690-0AK00)	Spacer (6GT2 690-0AK00)	Spacer (6GT2 690-0AK00)	Spacer (6GT2 690-0AL00)	Spacer (6GT2 690-0AL00)	Spacer (6GT2 690-0AL00)

Operating Distance Range (mm) / Maximum Distance for Stationary Tag (mm)

Operating Distance Range (inch) / Maximum Distance for Stationary Tag (inch)

















*compatible only with the RS422 variant of the readers.

RF200 Family Matrix 13.56 MHz Passive Tags Operational temperature range Dimensions (L x W x D) mm Ingress Protection (IP) rating	Antennas	D423 6GT2 600-4AA00 2 kbyte FRAM  -40°C to 100°C Ø 30 x 8 IP68/ IPx9K	D425 6GT2 600-4AG00 2 kbyte FRAM  -40°C to 125°C Ø 24 x 10 IP68/ IPx9K	D525* 6GT2 600-5AG00 8 kbyte FRAM  -40°C to 125°C Ø 24 x 10 IP68/ IPx9K	D428 6GT2 600-4AK00-0AX0 2 kbyte FRAM  -40°C to 125°C Ø18 x 20 IP68/ IPx9K	D528* 6GT2600-5AK00 8 kbyte FRAM  -40°C to 125°C Ø18 x 20 IP68/ IPx9K	D139 6GT2 600-0AA10 112 byte EEPROM  -40°C to 220°C Ø 85 x 15 IP68/ IPx9K	D339 6GT2600-3AA10 992 byte EEPROM  -40°C to 220°C Ø 85 x 15 IP68/ IPx9K
RF210R/ RF210M 6GT2 821-1AC10, RS422 6GT2 821-1AC32, IO-Link 6GT2 823-0AA00, Handheld (RS422) 	Integrated M18 x 71	2-10/ 12 (0,08-0.39/ 0.47)	1-6/ 7 (0.04-0.24/ 0.28)	1-6/ 7 (0.04-0.24/ 0.28)	1-10/ 11 (0.04-0.39/ 0.43)	1-10/ 11 (0.04-0.39/ 0.43)		
RF220R 6GT2 821-2AC10, RS422 6GT2 821-2AC32, IO-Link 	Integrated M30 x 71	2-24/ 28 (0,08-0.95/ 1.1)	1-11/ 13 (0.04-0.43/ 0.51)	1-11/ 13 (0.04-0.43/ 0.51)	1-18/ 21 (0.04-0.71/ 0.83)	1-15/ 20 (0.04-0.59/ 0.79)		
RF240R 6GT2 821-4AC10, RS422 6GT2 821-4AC40, RS232 (ASCII) 6GT2821-4AC32, IO-Link 	Integrated 50 x 50 x 30	2-35/ 40 (0.08-1.37/ 1.57)	1-15/ 17 (0.04-0.59/ 0.67)	1-15/ 17 (0.04-0.59/ 0.67)	1-30/ 34 (0.04-1.18/ 1.34)	1-30/ 35 (0.04-1.18/ 1.38)		
RF250R ANT 1 6GT2 821-5AC10, RS422 6GT2 821-5AC40, RS232 (ASCII) 6GT2821-5AC32, IO-Link 6GT2 398-1CB00, ANT 1 	 75 x 75 x 20					1-35/ 45 (0.04-1.38/ 1.77)		
RF250R ANT 3 6GT2 821-5AC10, RS422 6GT2 821-5AC40, RS232 (ASCII) 6GT2821-5AC32, IO-Link 6GT2 398-1CD40-0AX0, ANT 3 	 28 x 50 x 10	0-24/ 30 (0-0.95/ 1.18)	0-16/ 20 (0-0.63/ 0.79)	1-12/ 20 (0.04-0.59/ 0.79)	0-25/ 32 (0-0.98/ 1.26)	1-20/ 25 (0.04-0.79/ 0.98)		
RF250R ANT 3S 6GT2 821-5AC10, RS422 6GT2 821-5AC40, RS232 (ASCII) 6GT2821-5AC32, IO-Link 6GT2 398-1CD60-0AX0, ANT 3S 	 28 x 50 x 10							
RF250R ANT 8 6GT2 821-5AC10, RS422 6GT2 821-5AC40, RS232 (ASCII) 6GT2821-5AC32, IO-Link 6GT2 398-1CF10, ANT 8 	 Ø8 x 40							
RF250R ANT 12 6GT2 821-5AC10, RS422 6GT2 821-5AC40, RS232 (ASCII) 6GT2821-5AC32, IO-Link 6GT2 398-1CC00, ANT 12 	 Ø12 x 40		0-8/ 10 (0.0-0.31/ 0.39)	1-8/ 10 (0.04-0.31/ 0.39)	1-8/ 12 (0.04-0.31/ 0.59)	1-8/ 12 (0.04-0.31/ 0.47)		
Accessories		Mounting cover (6GT2 690-0AE00)					Spacer (6GT2 690-0AA00) Mount for quick tag exchange (6GT2 690-0AH00 - long) (6GT2 690-0AH10 - short)	Spacer (6GT2 690-0AA00) Mount for quick tag exchange (6GT2 690-0AH00 - long) (6GT2 690-0AH10 - short)

Operating Distance Range (mm) / Maximum Distance for Stationary Tag (mm)

Operating Distance Range (inch) / Maximum Distance for Stationary Tag (inch)

*compatible only with the RS422 variant of the readers.

RF200 Family Matrix 13.56 MHz Passive Tags Operational temperature range Dimensions (L x W x D) mm Ingress Protection (IP) rating	Antennas	D423 6GT2 600-4AA00 2 kbyte FRAM  -40°C to 100°C Ø 30 x 8 IP68/ IPx9K	D425 6GT2 600-4AG00 2 kbyte FRAM  -40°C to 125°C Ø 24 x 10 IP68/ IPx9K	D525* 6GT2 600-5AG00 8 kbyte FRAM  -40°C to 125°C Ø 24 x 10 IP68/ IPx9K	D428 6GT2 600-4AK00-0AX0 2 kbyte FRAM  -40°C to 125°C Ø18 x 20 IP68/ IPx9K	D528* 6GT2600-5AK00 8 kbyte FRAM  -40°C to 125°C Ø18 x 20 IP68/ IPx9K	D139 6GT2 600-0AA10 112 byte EEPROM  -40°C to 220°C Ø 85 x 15 IP68/IPx9K	D339 6GT2600-3AA10 992 byte EEPROM  -40°C to 220°C Ø 85 x 15 IP68/IPx9K
RF250R ANT 18 6GT2 821-5AC10, RS422 6GT2 821-5AC40, RS232 (ASCII) 6GT2821-5AC32, IO-Link 6GT2 398-1CA00, ANT 18 	 Ø18 x 55	1-15/ 18 (0.04-0.59/ 0.71)	1-11/ 16 (0.04-0.43/ 0.63)	1-11/ 16 (0.04-0.43/ 0.63)	1-18/ 25 (0.04-0.71/ 0.98)	1-15/ 20 (0.04-0.57/ 0.79)		
RF250R ANT 30 6GT2 821-5AC10, RS422 6GT2 821-5AC40, RS232 (ASCII) 6GT2821-5AC32, IO-Link 6GT2 398-1CD00, ANT 30 	 Ø30 x 58	0-18/ 26 (0-0.71/ 1.02)	1-12/ 20 (0.04-0.47/ 0.79)	1-12/ 20 (0.04-0.47/ 0.79)	1-20/ 32 (0.04-0.79/ 1.26)	1-20/ 25 (0.04-0.79/ 0.98)		
RF260R 6GT2 821-6AC10, RS422 6GT2 821-6AC40, RS232 (ASCII) 6GT2 821-6AC32, IO-Link 	Integrated 75 x 75 x 41	2-40/ 45 (0.08-1.57/ 1.77)			2-40/ 45 (0.08-1.57/ 1.77)	2-35/ 40 (0.08-1.38/ 1.57)	2-80/ 110 (0.08-3.15/ 4.33)	5-65/ 80 (0.20-2.56/ 3.15)
RF290R 6GT2 821-0AC12, RS232, RS422  Accessory: Set for top rail mounting 6GK5798-8ML00-0AB3	ANT D1  6GT2 698-5AC00 75 x 75 x 20	10-55/ 80 (0.39-2.17/ 3.15)			0-55/ 80 (0-2.17/ 3.15)	0-55/ 80 (0-2.17/ 3.15)	5-160/ 220 (0.20-6.30/ 8.66)	5-130/170 (0.20-5.12/ 6.69)
	ANT D5  6GT2 698-5AA10 380 x 380 x 110						0-400/ 500 (0-15.75/ 19.69)	0-300/ 380 (0-11.81/ 15.00)
	ANT D6  6GT2 698-5AB00 580 x 480 x 110						0-500/ 600 (0-19.69/ 23.62)	0-400/ 480 (0-15.75/ 18.9)
	ANT D10  6GT2 698-5AF00 1150 x 365 x 115						0-450/ 550 (0-17.72/ 21.65)	0-300/ 380 (0-11.81/ 15.00)
Accessories	Covering hood for ANT D6 (6GT2 690-0AD00)	Mounting cover (6GT2 690-0AE00)					Spacer (6GT2 690-0AA00) Mount for quick tag exchange (6GT2 690-0AH00 - long) (6GT2 690-0AH10 - short)	Spacer (6GT2 690-0AA00) Mount for quick tag exchange (6GT2 690-0AH00 - long) (6GT2 690-0AH10 - short)

Operating Distance Range (mm) / Maximum Distance for Stationary Tag (mm)

Operating Distance Range (inch) / Maximum Distance for Stationary Tag (inch)

*compatible only with the RS422 variant of the readers.

SIMATIC PLC

S7-1200

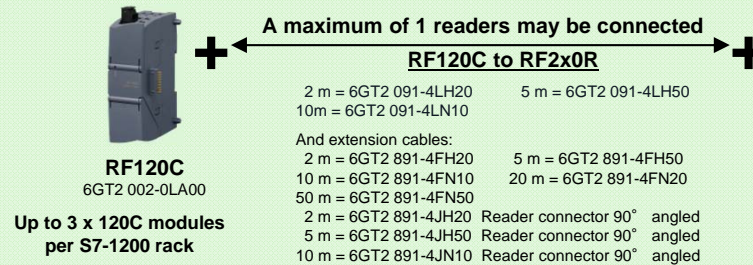

SIMATIC PLC

S7-300 Rack or S7-400 via ET 200M (DP-V1/PN-IO)

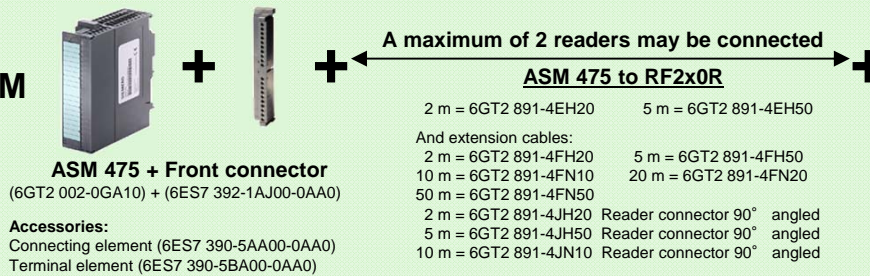

ET 200pro via PROFIBUS or PROFINET or S7 PLC

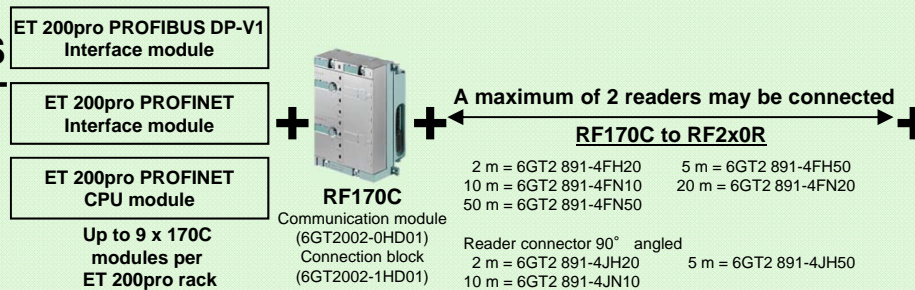

A tool called TIA Selection Tool is available for configuring a complete ET 200pro rack. You will find the tool on the Internet at: <http://www.siemens.com/tia-selection-tool-standalone>.

PROFINET

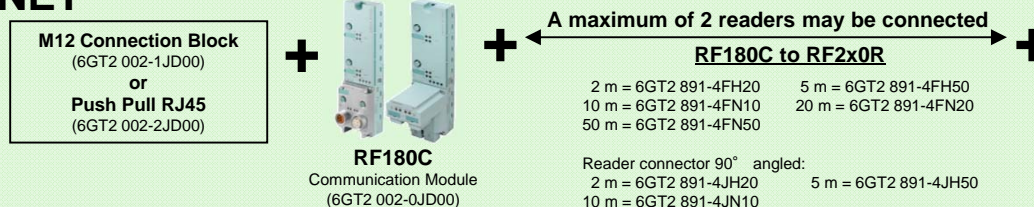

Reader

powered through connection cable



- ANT 1**
(6GT2 398-1CB00)
- ANT 3**
(6GT2 398-1CD40-0AX0)
- ANT 3S**
(6GT2 398-1CD60-0AX0)
- ANT 8**
(6GT2 398-1CF10)
- ANT 12**
(6GT2 398-1CC00)
- ANT 18**
(6GT2 398-1CA00)
- ANT 30**
(6GT2 398-1CD00)



- ANT D1**
(6GT2 698-5AC00)
- ANT D5**
(6GT2 698-5AA10)
- ANT D6**
(6GT2 698-5AB00)
- ANT D10**
(6GT2 698-5AF00)

Tags

- D100** (6GT2 600-0AD10)
- D200** (6GT2 600-1AD00-0AX0)
- D400** (6GT2 600-4AD00)
- D421** (6GT2 600-4AE00)
- D521** (6GT2 600-5AE00)
- D422** (6GT2 600-4AF00)
- D522** (6GT2 600-5AF00)
- D522** (6GT2 600-5AF00-0AX0)
- D124** (6GT2 600-0AC10)
- D324** (6GT2 600-3AC00)
- D424** (6GT2 600-4AC00)
- D524** (6GT2 600-5AC00)
- D423** (6GT2 600-4AA00)
- D425** (6GT2 600-4AG00)
- D525** (6GT2 600-4AB00)
- D127** (6GT2 600-4AF00)
- D117** (6GT2 398-1CF00)
- D428** (6GT2 600-4AK00-0AX0)
- D528** (6GT2 600-1AB00-0AX0)
- D126** (6GT2 600-0AE00)
- D426** (6GT2 600-4AH00)
- D526** (6GT2 600-5AH00)
- D139** (6GT2 600-0AA10)
- D339** (6GT2 600-3AA10)
- D160** (6GT2 600-0AB10)
- D460** (6GT2 600-4AB00)
- D165** (6GT2 600-1AB00-0AX0)
- D261** (6GT2 600-1AA01-0AX0)

PROFIBUS

ECOFAST Connection Block
(6ES7 194-3AA00-0AA0)
With Connector for adjusting PROFIBUS address
(6ES7 194-1KB00-0XA0)
or
M12 Connection Block
(6ES7 194-3AA00-0BA0)

ASM 456 (DP-V1)
Communication Module
(6GT2 002-0ED00)
RF160C (DP-V0)
Communication Module
(6GT2 002-0EF00)

A maximum of 2 readers may be connected
ASM 456/ RF160C to RF2x0R

2 m = 6GT2 891-4FH20 5 m = 6GT2 891-4FH50
10 m = 6GT2 891-4FN10 20 m = 6GT2 891-4FN20
50 m = 6GT2 891-4FN50

Reader connector 90° angled
2 m = 6GT2 891-4JH20 5 m = 6GT2 891-4JH50
10 m = 6GT2 891-4JN10

Ethernet TCP/IP



Ethernet TP cable through switch. See Page 60 for RF182C Cabling/ Connectors

RF182C
Communication Module
(6GT2 002-0JD10)

Computers and non Siemens PLCs

Connection Blocks:
M12, 7/8" – 5 pole power (6GT2 002-1JD00)
Push Pull RJ45 (6GT2 002-2JD00)
M12, 7/8" – 4 pole power (6GT2 002-4JD00)

A maximum of 2 readers may be connected
RF182C to RF2X0R

2 m = 6GT2 891-4FH20 5 m = 6GT2 891-4FH50
10 m = 6GT2 891-4FN10 20 m = 6GT2 891-4FN20
50 m = 6GT2 891-4FN50

Reader connector 90° angled
2 m = 6GT2 891-4JH20 5 m = 6GT2 891-4JH50
10 m = 6GT2 891-4JN10

Ethernet/IP

RFID 181EIP
Communication Module
(6GT2 002-0JD20)

Connection Blocks:
M12, 7/8" – 5 pole power (6GT2 002-1JD00)
M12, 7/8" – 4 pole power (6GT2 002-4JD00)

A maximum of 2 readers may be connected
RFID 181EIP to RF2x0R

2 m = 6GT2 891-4FH20 5 m = 6GT2 891-4FH50
10 m = 6GT2 891-4FN10 20 m = 6GT2 891-4FN20
50 m = 6GT2 891-4FN50

Reader connector 90° angled
2 m = 6GT2 891-4JH20 5 m = 6GT2 891-4JH50
10 m = 6GT2 891-4JN10

Reader

powered through connection cable

RF210R
(6GT2 821-1AC10)

RF210M
(6GT2 823-0AA00)

RF220R
(6GT2 821-2AC10)

RF240R
(6GT2 821-4AC10)

RF250R
(6GT2 821-5AC10)

RF260R
(6GT2 821-6AC10)

RF290R
(6GT2 821-0AC12)

Opt. Splitter w/ D5, D6 only
(6GT2 690-0AC00)

ANT 1
(6GT2 398-1CB00)
ANT 3
(6GT2 398-1CD40-0AX0)
ANT 3S
(6GT2 398-1CD60-0AX0)
ANT 8
(6GT2 398-1CF10)
ANT 12
(6GT2 398-1CC00)
ANT 18
(6GT2 398-1CA00)
ANT 30
(6GT2 398-1CD00)

Tags

- D100** (6GT2 600-0AD10)
- D200** (6GT2 600-1AD00-0AX0)
- D400** (6GT2 600-4AD00)
- D421** (6GT2 600-4AE00)
- D521** (6GT2 600-5AE00)
- D422** (6GT2 600-4AF00)
- D522** (6GT2 600-5AF00)
- D522** (6GT2 600-5AF00-0AX0)
- D124** (6GT2 600-0AC10)
- D324** (6GT2 600-3AC00)
- D424** (6GT2 600-4AC00)
- D524** (6GT2 600-5AC00)
- D423** (6GT2 600-4AA00)
- D425** (6GT2 600-4AG00)
- D525** (6GT2 600-4AB00)
- D127** (6GT2 600-4AF00)
- D117** (6GT2 398-1CF00)
- D428** (6GT2 600-4AK00-0AX0)
- D528** (6GT2 600-1AB00-0AX0)
- D126** (6GT2 600-0AE00)
- D426** (6GT2 600-4AH00)
- D526** (6GT2 600-5AH00)
- D139** (6GT2 600-0AA10)
- D339** (6GT2 600-3AA10)
- D160** (6GT2 600-0AB10)
- D460** (6GT2 600-4AB00)
- D165** (6GT2 600-1AB00-0AX0)
- D261** (6GT2 600-1AA01-0AX0)

RS232 / ASCII

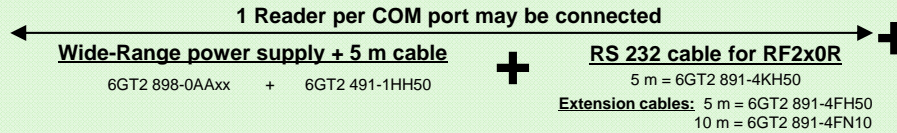

Simple text based protocol

Reader

with external power supply at Y-cable



- ANT 1**
(6GT2 398-1CB00)
- ANT 3**
(6GT2 398-1CD40-0AX0)
- ANT 3S**
(6GT2 398-1CD60-0AX0)
- ANT 8**
(6GT2 398-1CF10)
- ANT 12**
(6GT2 398-1CC00)
- ANT 18**
(6GT2 398-1CA00)
- ANT 30**
(6GT2 398-1CD00)

Tags

- D100** (6GT2 600-0AD10)
- D200** (6GT2 600-1AD00-0AX0)
- D400** (6GT2 600-4AD00)
- D421** (6GT2 600-4AE00)
- D521*** (6GT2 600-5AE00)
- D422** (6GT2 600-4AF00)
- D522** (6GT2 600-5AF00)
- D522*** (6GT2 600-5AF00-0AX0)
- D124** (6GT2 600-0AC10)
- D324** (6GT2 600-3AC00)
- D424** (6GT2 600-4AC00)
- D524*** (6GT2 600-5AC00)
- D423** (6GT2 600-4AA00)
- D425** (6GT2 600-4AG00)
- D525*** (6GT2 600-4AB00)
- D127** (6GT2 600-4AF00)
- D117** (6GT2 398-1CF00)
- D428** (6GT2 600-4AK00-0AX0)
- D528*** (6GT2 600-1AB00-0AX0)
- D126** (6GT2 600-0AE00)
- D426** (6GT2 600-4AH00)
- D526*** (6GT2 600-5AH00)
- D139** (6GT2 600-0AA10)
- D339** (6GT2 600-3AA10)
- D160** (6GT2 600-0AB10)
- D460** (6GT2 600-4AB00)
- D165** (6GT2 600-1AB00-0AX0)
- D261** (6GT2 600-1AA01-0AX0)

RS232

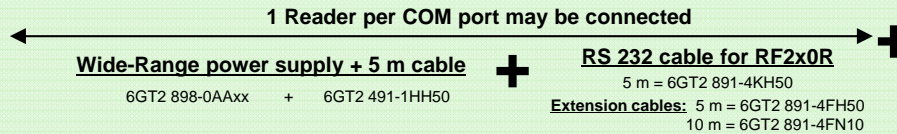

RF290R Tool for Configuration on DVD
Binary based protocol or Scanmode

Reader

with external power supply at Y-cable



- ANT D1**
(6GT2 698-5AC00)
- ANT D5**
(6GT2 698-5AA10)
- ANT D6**
(6GT2 698-5AB00)
- ANT D10**
(6GT2 698-5AF00)

* only in combination with RF290R reader (on this page)

IO-Link: S7-1200

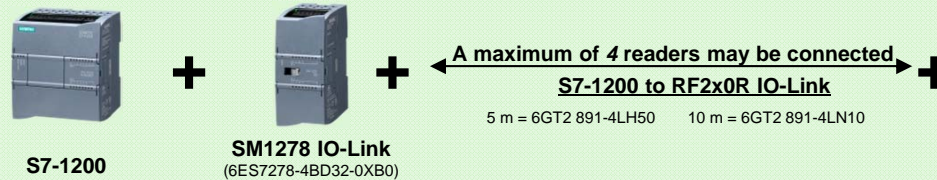

IO-Link: ET 200SP

via PROFIBUS
or PROFINET
or S7 PLC

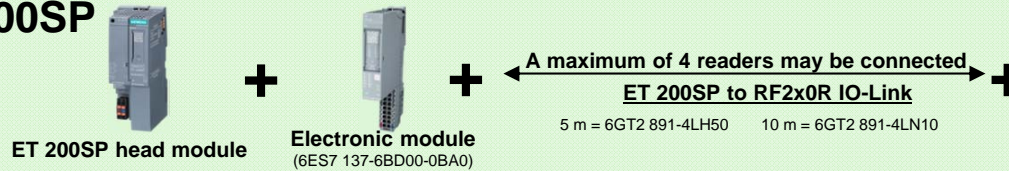

IO-Link: ET 200S

via PROFIBUS
or PROFINET
or S7 PLC

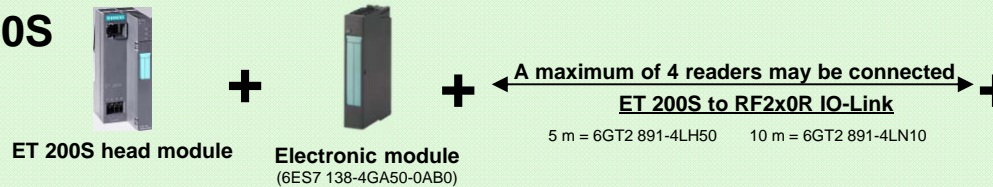

IO-Link: ET 200AL

via PROFIBUS
or PROFINET

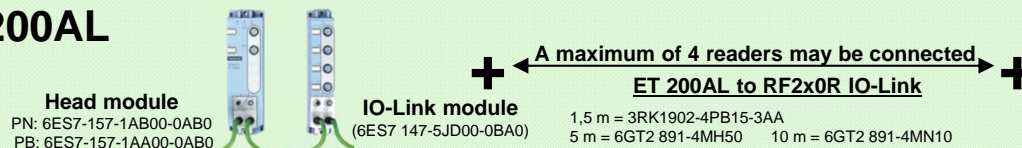

IO-Link PROFINET

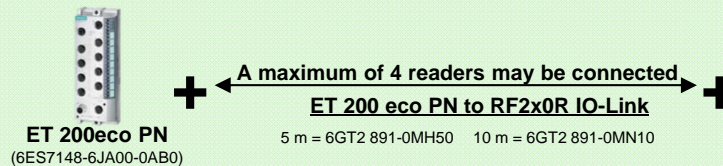

IO-Link: Other Master

Vendors of IO-Link Master Devices	Central Controller	Profibus	Profinet	Interbus	EtherCat	Powerlink	Ethernet/IP	Modbus TCP	SERCOS III	CC-Link	CANopen	DeviceNet	AS-Interface	USB
(according to www.io-link.com)														
B&R	x	x	x				x	x	x	x	x	x		
Balluff		x	x											x
Beckhoff	x	x	x	x	x		x	x	x	x	x	x		
Bosch Rexroth	x	x	x											
Comtrol								x	x					
ifm electronic gmbh													x	x
Mitsubishi Electric	x													
Murrelektronik		x	x											
PhoenixContact	x	x	x	x	x		x	x	x					
Siemens AG	x	x	x											
TMG TE GmbH														x
WAGO	x	x	x		x		x	x	x			x	x	
Wenglor	x													x

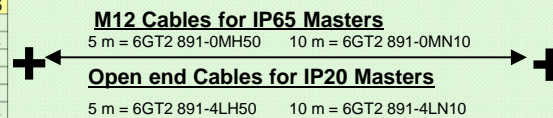

Reader

powered through connection cable



RF210R IO-Link
(6GT2 821-1AC32)



RF220R IO-Link
(6GT2 821-2AC32)



RF240R IO-Link
(6GT2 821-4AC32)

















RF250R IO-Link
(6GT2 821-5AC32)

















RF260R IO-Link
(6GT2 821-6AC32)

Tags



















- D100** (6GT2 600-0AD10)
- D200** (6GT2 600-1AD00-0AX0)
- D400** (6GT2 600-4AD00)
- D421** (6GT2 600-4AE00)
- D422** (6GT2 600-4AF00)
- D124** (6GT2 600-0AC10)
- D324** (6GT2 600-3AC00)
- D424** (6GT2 600-4AC00)
- D423** (6GT2 600-4AA00)
- D425** (6GT2 600-4AG00)
- D127** (6GT2 600-4AF00)
- D117** (6GT2 398-1CF00)
- D428** (6GT2 600-4AK00-0AX0)
- D126** (6GT2 600-0AE00)
- D426** (6GT2 600-4AH00)
- D139** (6GT2 600-0AA10)
- D339** (6GT2 600-3AA10)
- D160** (6GT2 600-0AB10)
- D460** (6GT2 600-4AB00)
- D165** (6GT2 600-1AB00-0AX0)
- D261** (6GT2 600-1AA01-0AX0)

RF300 Family Matrix (RF300 Tags) 13.56 MHz Passive Tags Operational Temperature Range Dimensions(L x W x D) mm Ingress Protection (IP) Rating	Antennas	Suitable for Dynamic Operation	RF320T 6GT2 800-1CA00 20 byte EEPROM  -40°C to 140°C Ø 27 x 4 IP67/IPX9K	RF330T 6GT2 800-5BA00 20 byte EEPROM 32 kbyte FRAM  -40°C to 100°C Ø 30 x 8 IP68/IPX9K	RF340T 20 byte EEPROM + 6GT2 800-4BB00 8 kbyte FRAM 6GT2 800-5BB00 32 kByte FRAM  -40°C to 85°C 48 x 25 x 15 IP67/IPX9K	RF350T 6GT2 800-5BD00 20 byte EEPROM 32 kbyte FRAM  -40°C to 85°C 50 x 50 x 20 IP68	RF360T 20 byte EEPROM + 6GT2 800-4AC00 8 kbyte FRAM 6GT2 800-5AC00 32 kbyte FRAM  -40°C to 85°C 85,8 x 54,1 x 2,5 IP67	RF370T 20 Byte EEPROM + 6GT2 800-5BE00 32 kbyte FRAM 6GT2 800-6BE00 64 kbyte FRAM  -40°C to 85°C 75 x 75 x 41 IP68	RF380T 6GT2 800-5DA00 20 byte EEPROM 32 kbyte FRAM  -25°C to 110°C (-40°C to 220°C) Ø 114 x 83 IP68
RF310R (from Rev. D) RS422 6GT2 801-1AB10 6GT2 801-1AB20-0AX1 (Scanmode) 	Integrated 55 x 75 x 30	YES	1-23/ 26 (0.04-0.91/ 1.02)	2-18/ 21 (0.08-0.71/ 0.83)	2-36/ 41 (0.08-1.42/ 1.61)	2-47/ 53 (0.08-1.85/ 2.09)	2-60/68 (0.08-2.36/ 2.68)		
RF340R RS422 6GT2 801-2AB10 	Integrated 75 x 75 x 41	YES	1-20/ 25 (0.04-0.79/ 0.98)	2-20/ 24 (0.08-0.79/ 0.94)	2-50/ 65 (0.08-1.97/ 2.56)	2-60/ 75 (0.08-2.36/ 2.95)	2-65/ 85 (0.08-2.56/ 3.35)	5-60/ 80 (0.2-2.36/ 3.15)	5-80/ 100 (0.2-2.36/ 3.94)
RF350R ANT 1 RS422 6GT2 801-4AB10, RF350R 6GT2 398-1CB00, ANT 1 	 75 x 75 x 20	YES	1-30/ 40 (0.04-1.18/ 1.57)	2-25/ 30 (0.08-0.98/ 1.18)	2-55/ 70 (0.08-2.16/ 2.76)	2-65/ 85 (0.08-2.56/ 3.35)	2-75/ 100 (0.08-2.95/ 3.94)	5-65/ 85 (0.2-2.56/ 3.35)	5-90/ 110 (0.2-3.54/ 4.33)
RF350R ANT 3 RS422 6GT2 801-4AB10, RF350R 6GT2 398-1CD40-0AX0, ANT 3 	 28 x 50 x 10	NO	1-16 / 20 (0.04-0.63/ 0.79)	1-16 / 20 (0.04-0.63/ 0.79)	2-32/ 40 (0.08-1.26/ 1.57)	2-35/ 42 (0.08-1.38/ 1.65)			
RF350R ANT 3S RS422 6GT2 801-4AB10, RF350R 6GT2 398-1CD60-0AX0, ANT 3S 	 28 x 50 x 10	NO							
Accessories			Spacer (6GT2 690-0AK00)	Mounting cover (6GT2 690-0AE00)			20 mm spacer (6GT2 190-0AA00) Fixing pocket (6GT2 190-0AB00)		Holder: (short: 6GT2 090-0QA00) (long: 6GT2 090-0QA00- 0AX3) Cover for holder: (6GT2 090-0QB00) All Purpose Support (6GT2 590-0QA00)

Operating Distance Range (mm) / Maximum Distance for Stationary Tag (mm)
 Operating Distance Range (inch) / Maximum Distance for Stationary Tag (inch)











RF300 Family Matrix (RF300 Tags) 13.56 MHz Passive Tags Operational Temperature Range Dimensions(L x W x D) mm Ingress Protection (IP) Rating	Antennas	Suitable for Dynamic Operation	RF320T 6GT2 800-1CA00 20 byte EEPROM  -40°C to 140°C Ø 27 x 4 IP67/IPX9K	RF330T 6GT2 800-5BA00 20 byte EEPROM 32 kbyte FRAM  -40°C to 100°C Ø 30 x 8 IP68/IPX9K	RF340T 20 byte EEPROM + 6GT2 800-4BB00 8 kbyte FRAM 6GT2 800-5BB00 32 kByte FRAM  -40°C to 85°C 48 x 25 x 15 IP67/IPX9K	RF350T 6GT2 800-5BD00 20 byte EEPROM 32 kbyte FRAM  -40°C to 85°C 50 x 50 x 20 IP68	RF360T 20 byte EEPROM + 6GT2 800-4AC00 8 kbyte FRAM 6GT2 800-5AC00 32 kbyte FRAM  -40°C to 85°C 85,8 x 54,1 x 2,5 IP67	RF370T 20 Byte EEPROM + 6GT2 800-5BE00 32 kbyte FRAM 6GT2 800-6BE00 64 kbyte FRAM  -40°C to 85°C 75 x 75 x 41 IP68	RF380T 6GT2 800-5DA00 20 byte EEPROM 32 kbyte FRAM  -25°C to 110°C (-40°C to 220°C) Ø 114 x 83 IP68
RF350R ANT 12 RS422  6GT2 801-4AB10, RF350R 6GT2 398-1CC00, ANT 12	 Ø12 x 40	NO		0-5/ 7 (0-0.20/ 0.28)			1-5/ 7 (0.04-0.20/ 0.28)		
RF350R ANT 18 RS422  6GT2 801-4AB10, RF350R 6GT2 398-1CA00, ANT 18	 Ø18 x 55	NO	0-10/ 15 (0-0.39/ 0.59)	1-11/ 13 (0.04-0.43/ 0.51)	0-20/ 25 (0.0-0.79/ 0.98)				
RF350R ANT 30 RS422  6GT2 801-4AB10, RF350R 6GT2 398-1CD00, ANT 30	 Ø30 x 58	NO	0-15/ 20 (0-0.59/ 0.79)	2-15/ 18 (0.08-0.59/ 0.71)	0-30/ 35 (0.0-1.18/ 1.38)	0-35/ 40 (0-1.18/ 1.57)			
RF380R RS422, RS232  6GT2 801-3AB10 6GT2 801-3AB20-0AX1 (Scanmode)	Integrated 160 x 96 x 41	YES	2-45/ 60 (0.08-1.77/ 2.36)	5-45/ 52 (0.2-1.77/ 2.36)	2-80/ 105 (0.08-3.15/ 4.13)	2-100/ 125 (0.08-3.94/ 4.92)	2-120/ 150 (0.08-4.72/ 5.91)	5-100/ 135 (0.2-3.94/ 5.31)	5-125/ 160 (0.2-3.94/ 5.51)
Accessories			Spacer (6GT2 690-0AK00)	Mounting cover (6GT2 690-0AE00)			20 mm spacer (6GT2 190-0AA00) Fixing pocket (6GT2 190-0AB00)		Holder: (short: 6GT2 090-0QA00) (long: 6GT2 090-0QA00- 0AX3) Cover for holder: (6GT2 090-0QB00) All Purpose Support (6GT2 590-0QA00)

Operating Distance Range (mm) / Maximum Distance for Stationary Tag (mm)
 Operating Distance Range (inch) / Maximum Distance for Stationary Tag (inch)

RF300 Family Matrix (ISO Tags) 13.56 MHz Passive Tags Operational Temperature Range Dimensions(L x W x D) mm Ingress Protection (IP) Rating	Antennas	D165 6GT2 600-1AB00-0AX0 112 byte EEPROM  -25°C to 85°C 86 x 54 x 0,3 IP65	D261 6GT2 600-1AA01-0AX0 256 byte EEPROM  -25°C to 85°C 55 x 55 x 0,3 IP65	D100 6GT2 600-0AD10 112 byte EEPROM  -25°C to 80°C 85,6 x 54 x 0,9 IP68	D200 6GT2 600-1AD00 -0AX0 256 byte EEPROM  -20°C to 60°C 85,6 x 54 x 0,8 IP67	D400 6GT2 600-4AD00 2 kbyte FRAM  -20°C to 60°C 85,6 x 54 x 0,8 IP67	D160 6GT2 600-0AB10 112 byte EEPROM  -40°C to 175°C Ø 16 x 3 IP68/IPx9K	D460 6GT2 600-4AB00 2 kbyte FRAM  -40°C to 100°C Ø 16 x 3 IP67/IPx9K
RF310R (from Rev. D) RS422  6GT2 801-1AB10 6GT2 801-1AB20-0AX1 (Scanmode)	Integrated 55 x 75 x 30	2-90/ 102 (0.08-3.54/ 4.02)	2-74/ 83 (0.08-2.91/ 3.27)	2-93/ 105 (0.08-3.66/ 4.1)	2-84/ 95 (0.08-3.3/ 3.74)	2-104/ 117 (0.08-4.09/ 4.61)	1-39/ 44 (0.04-1.54/ 1.73)	1-37/ 41 (0.08-1.46/ 1.61)
RF340R RS422  6GT2 801-2AB10	Integrated 75 x 75 x 41	5-100/ 125 (0.20-3.94/ 4.92)	5-60/ 70 (0.02-2.36/ 2.76)	5-110/ 140 (0.20-4.33/ 5.51)	5-80/ 110 (0.20-3.15/ 4.33)	2-100/ 130 (0.08-3.93/ 5.12)	2-35/ 60 (0.08-1.38/ 2.36)	2-25/ 40 (0.08-0.98/ 1.57)
RF350R ANT 1 RS422  6GT2 801-4AB10, RF350R 6GT2 398-1CB00, ANT 1	 75 x 75 x 20	5-100/ 120 (0.20-3.94/ 4.72)	5-80/ 95 (0.20-3.15/ 3.74)	5-110/ 140 (0.20-4.33/ 5.51)	5-95/ 115 (0.20-3.74/ 4.52)	2-110/ 140 (0.08-4.33/ 5.51)	2-35/ 60 (0.08-1.38/ 2.36)	2-35/ 50 (0.08-1.38/ 1.97)
RF350R ANT 3 RS422  6GT2 801-4AB10, RF350R 6GT2 398-1CD40-0AX0, ANT 3	 28 x 50 x 10						1-16/ 20 (0.04-0.63/ 0.79)	0-18/ 25 (0-0.71/ 0.98)
RF350R ANT 3S RS422  6GT2 801-4AB10, RF350R 6GT2 398-1CD60-0AX0, ANT 3S	 28 x 50 x 10							
RF350R ANT 12 RS422  6GT2 801-4AB10, RF350R 6GT2 398-1CC00, ANT 12	 Ø12 x 40						0-8/ 15 (0-0.31/ 0.59)	1-10/ 14 (0.04-0.39/ 0.55)
RF350R ANT 18 RS422  6GT2 801-4AB10, RF350R 6GT2 398-1CA00, ANT 18	 Ø18 x 55						1-18/ 27 (0.04-0.71/ 1.06)	1-12/ 18 (0.04-0.47/ 0.71)
Accessories				Holder (6GT2 390-0AA00) 20 mm spacer (6GT2 190-0AA00) Fixing pocket (6GT2 190-0AB00)	Holder (6GT2 390-0AA00) 20 mm spacer (6GT2 190-0AA00) Fixing pocket (6GT2 190-0AB00)	Holder (6GT2 390-0AA00) 20 mm spacer (6GT2 190-0AA00) Fixing pocket (6GT2 190-0AB00)	Spacer (6GT2690-0AG00)	Spacer (6GT2690-0AG00)



















Operating Distance Range (mm) / Maximum Distance for Stationary Tag (mm)

Operating Distance Range (inch) / Maximum Distance for Stationary Tag (inch)

RF300 Family Matrix (ISO Tags) 13.56 MHz Passive Tags Operational Temperature Range Dimensions(L x W x D) mm Ingress Protection (IP) Rating	Antennas	D165 6GT2 600-1AB00-0AX0 112 byte EEPROM  -25°C to 85°C 86 x 54 x 0,3 IP65	D261 6GT2 600-1AA01-0AX0 256 byte EEPROM  -25°C to 85°C 55 x 55 x 0,3 IP65	D100 6GT2 600-0AD10 112 byte EEPROM  -25°C to 80°C 85,6 x 54 x 0,9 IP68	D200 6GT2 600-1AD00 -0AX0 256 byte EEPROM  -20°C to 60°C 85,6 x 54 x 0,8 IP67	D400 6GT2 600-4AD00 2 kbyte FRAM  -20°C to 60°C 85,6 x 54 x 0,8 IP67	D160 6GT2 600-0AB10 112 byte EEPROM  -40°C to 175°C Ø 16 x 3 IP68/IPx9K	D460 6GT2 600-4AB00 2 kbyte FRAM  -40°C to 100°C Ø 16 x 3 IP67/IPx9K
RF350R ANT 30 RS422  6GT2 801-4AB10, RF350R 6GT2 398-1CD00, ANT 30	 Ø30 x 58						1-25/ 30 (0.04-0.98/ 1.18)	1-18/ 25 (0.04-0.71/ 0.98)
RF380R RS422, RS232  6GT2 801-3AB10 6GT2 801-3AB20-0AX1 (Scan mode)	Integrated 160 x 96 x 41	5-170/ 200 (0.20-6.69/ 7.87)	5-120/ 160 (0.20-4.72/ 6.30)	5-170/ 210 (0.20-6.69/ 8.27)	5-150/195 (0.20-5.90/ 7.67)	2-200/ 240 (0.08-7.87/ 9.45)	2-64/ 80 (0.08-2.52/ 3.15)	2-65/ 90 (0.08-3.56/ 3.54)
RF382R RS422, RS232  6GT2 801-3AB20-0AX0	Integrated 160 x 96 x 41						35-50/ 65 (1.38-1.97/ 2.56)	30-50/ 60 (1.18-1.97/ 2.36)
Accessories				Holder (6GT2 390-0AA00) 20 mm spacer (6GT2 190-0AA00) Fixing pocket (6GT2 190-0AB00)	Holder (6GT2 390-0AA00) 20 mm spacer (6GT2 190-0AA00) Fixing pocket (6GT2 190-0AB00)	Holder (6GT2 390-0AA00) 20 mm spacer (6GT2 190-0AA00) Fixing pocket (6GT2 190-0AB00)	Spacer (6GT2690-0AG00)	Spacer (6GT2690-0AG00)

Operating Distance Range (mm) / Maximum Distance for Stationary Tag (mm)

Operating Distance Range (inch) / Maximum Distance for Stationary Tag (inch)

RF300 Family Matrix (ISO Tags) 13.56 MHz Passive Tags Operational Temperature Range Dimensions(L x W x D) mm Ingress Protection (IP) Rating	Antennas	D117 6GT2 600-0AG00 112 byte EEPROM  -40°C to 125°C Ø4 x 5 IP68	D127 6GT2 600-0AF00 112 byte EEPROM  -40°C to 125°C Ø 6 x 6 IP68/ IPx9K	D421 6GT2 600-4AE00 2 kbyte FRAM  -40°C to 100°C Ø10 x 4,5 IP67/ IPx9K	D422 6GT2 600-4AF00 2 kbyte FRAM  -40°C to 100°C Ø20 x 6 IP68	D124 6GT2 600-0AC10 112 byte EEPROM  -40°C to 180°C Ø 27 x 4 IP68/ IPx9K	D324 6GT2 600-3AC00 992 byte EEPROM  -40°C to 140°C Ø 27 x 4 IP67	D424 6GT2 600-4AC00 2 kbyte FRAM  -40°C to 100°C Ø 27 x 4 IP67/ IPx9K
RF310R (from Rev. D) RS422  6GT2 801-1AB10 6GT2 801-1AB20-0AX1 (Scanmode)	Integrated 55 x 75 x 30					2-64/ 72 (0.08-2.52/ 2.80)	2-47/ 63 (0.08-1.85/ 2.48)	1-70/ 78 (0.04-2.76/ 3.07)
RF340R RS422  6GT2 801-2AB10	Integrated 75 x 75 x 41					2-60/ 75 (0.08-2.36/ 2.95)	2-55/ 70 (0.08-2.17/ 2.76)	2-55/ 70 (0.08-2.17/ 2.76)
RF350R ANT 1 RS422  6GT2 801-4AB10, RF350R 6GT2 398-1CB00, ANT 1	 75 x 75 x 20					2-65/ 85 (0.08-2.56/ 3.35)	2-70/ 90 (0.08-2.76/ 3.54)	2-60/ 80 (0.08-2.36/ 3.15)
RF350R ANT 3 RS422  6GT2 801-4AB10, RF350R 6GT2 398-1CD40-0AX0, ANT 3	 28 x 50 x 10				1-12/ 15 (0.04-0.47/ 0.59)	0-35/ 42 (0-1.38/ 1.65)	2-32/ 40 (0-1.26/ 1.57)	0-42/ 48 (0-1.65/ 1.89)
RF350R ANT 3S RS422  6GT2 801-4AB10, RF350R 6GT2 398-1CD60-0AX0, ANT 3S	 28 x 50 x 10	0-2/ 3 (0.0-0.08/ 0.12)	0-2/ 3 (0-0.08/ 0.12)	0-4/ 5 (0-0.16/ 0.20)				
RF350R ANT 12 RS422  6GT2 801-4AB10, RF350R 6GT2 398-1CC00, ANT 12	 Ø12 x 40	0-3/ 4 (0.0-0.12/ 0.16)	0-3/ 4 (0-0.12/ 0.16)	0-3/ 5 (0-0.12/ 0.20)				
RF350R ANT 18 RS422  6GT2 801-4AB10, RF350R 6GT2 398-1CA00, ANT 18	 Ø18 x 55	1-3/ 4 (0.0-0.12/ 0.16)	0-4/ 5 (0-0.16/ 0.20)	0-6/ 8 (0-0.24/ 0.31)	1-10/ 13 (0.04-0.39/ 0.51)	2-24/ 34 (0.08-0.94/ 1.34)	1-22/ 28 (0.04-0.87/ 1.1)	1-27/ 35 (0.04-1.06/ 1.38)
Accessories						Spacer (6GT2 690-0AK00)	Spacer (6GT2 690-0AK00)	Spacer (6GT2 690-0AK00)



















Operating Distance Range (mm) / Maximum Distance for Stationary Tag (mm)

Operating Distance Range (inch) / Maximum Distance for Stationary Tag (inch)

RF300 Family Matrix (ISO Tags) 13.56 MHz Passive Tags Operational Temperature Range Dimensions(L x W x D) mm Ingress Protection (IP) Rating	Antennas	D117 6GT2 600-0AG00 112 byte EEPROM  -40°C to 125°C Ø4 x 5 IP68	D127 6GT2 600-0AF00 112 byte EEPROM  -40°C to 125°C Ø 6 x 6 IP68/ IPx9K	D421 6GT2 600-4AE00 2 kbyte FRAM  -40°C to 100°C Ø10 x 4,5 IP67/ IPx9K	D422 6GT2 600-4AF00 2 kbyte FRAM  -40°C to 100°C Ø20 x 6 IP68	D124 6GT2 600-0AC10 112 byte EEPROM  -40°C to 180°C Ø 27 x 4 IP68/ IPx9K	D324 6GT2 600-3AC00 992 byte EEPROM  -40°C to 140°C Ø 27 x 4 IP67	D424 6GT2 600-4AC00 2 kbyte FRAM  -40°C to 100°C Ø 27 x 4 IP67/ IPx9K
RF350R ANT 30 RS422 6GT2 801-4AB10, RF350R 6GT2 398-1CD00, ANT 30 	 Ø30 x 58				0-15/ 19 (0-0.59/ 0.75)	1-35/ 46 (0.04-1.38/ 1.81)	1-35/ 45 (0.04-1.38/ 1.77)	0-45/ 50 (0-1.77/ 1.97)
RF380R RS422, RS232 6GT2 801-3AB10 6GT2 801-3AB20-0AX1 (Scanmode) 	Integrated 160 x 96 x 41					1-120/ 140 (0.04-4.72/ 5.51)	2-96/ 120 (0.08-3.78/ 4.72)	2-120/ 140 (0.08-4.72/ 5.51)
RF382R RS422, RS232 6GT2 801-3AB20-0AX0 	Integrated 160 x 96 x 41					40-65/ 75 (1.57-2.56/ 2.95)	40-65/ 75 (1.57-2.56/ 2.95)	40-65/ 75 (1.57-2.56/ 2.95)
Accessories						Spacer (6GT2 690-0AK00)	Spacer (6GT2 690-0AK00)	Spacer (6GT2 690-0AK00)











Operating Distance Range (mm) / Maximum Distance for Stationary Tag (mm)

Operating Distance Range (inch) / Maximum Distance for Stationary Tag (inch)

RF300 Family Matrix (ISO Tags) 13.56 MHz Passive Tags Operational Temperature Range Dimensions(L x W x D) mm Ingress Protection (IP) Rating	Antennas	D126 6GT2 600-0AE00 112 byte EEPROM  -40°C to 100°C Ø 50 x 3,6 IP68	D426 6GT2 600-4AH00 2 kbyte FRAM  -40°C to 100°C Ø 50 x 3,6 IP68	D423 6GT2 600-4AA00 2 kbyte FRAM  -40°C to 100°C Ø 30 x 8 IP68/ IPx9K	D425 6GT2 600-4AG00 2 kbyte FRAM  -40°C to 125°C Ø 24 x 10 IP68/ IPx9K	D428 6GT2 600-4AK00-0AX0 2 kbyte FRAM  -40°C to 125°C Ø 18 x 20 IP68/ IPx9K	D139 6GT2 600-0AA10 112 byte EEPROM  -40°C to 220°C Ø 85 x 15 IP68/IPx9K	D339 6GT2600-3AA10 992 byte EEPROM  -40°C to 220°C Ø 85 x 15 IP68/IPx9K
RF310R (from Rev. D) RS422  6GT2 801-1AB10 6GT2 801-1AB20-0AX1 (Scanmode)	Integrated 55 x 75 x 30	2-65/ 73 (0.08-2.56/ 2.87)	5-100/ 113 (0.2-3.94/ 4.45)	2-35/ 45 (0.08-1.37/ 1.77)	1-22/ 25 (0.04-0.87/ 0.98)	1-43/ 48 (0.08-1.69/ 1.89)	5-96/ 109 (0.20-3.78/ 4.29)	5-74/ 84 (0.20-2.91/ 3.31)
RF340R RS422  6GT2 801-2AB10	Integrated 75 x 75 x 41	2-85/ 110 (0.08-3.34/ 4.33)	0-80/ 100 (0.0-3.15/ 3.94)	2-40/ 55 (0.08-1.57/ 2.17)	2-18/ 27 (0.08-0.71/ 1.06)	2-35/ 50 (0.08-1.38/ 1.97)	5-80/ 110 (0.20-3.15/ 4.33)	5-75/ 85 (0.20-2.95/ 3.35)
RF350R ANT 1 RS422  6GT2 801-4AB10, RF350R 6GT2 398-1CB00, ANT 1	 75 x 75 x 20	2-90/ 120 (0.08-3.54/ 4.72)	0-85/ 110 (0.0-3.35/ 4.33)	2-50/ 70 (0.08-1.97/ 2.76)	2-23/ 32 (0.08-0.91/ 1.26)	2-35/ 50 (0.08-1.38/ 1.97)	5-85/ 115 (0.20-3.35/ 4.53)	5-90/ 105 (0.20-3.54/ 4.13)
RF350R ANT 3 RS422  6GT2 801-4AB10, RF350R 6GT2 398-1CD40-0AX0, ANT 3	 28 x 50 x 10			0-25/ 32 (0-0.98/ 1.26)	1-16/ 20 (0.04-0.63/ 0.79)	0-25/ 32 (0-0.98/ 1.26)		
RF350R ANT 3S RS422  6GT2 801-4AB10, RF350R 6GT2 398-1CD60-0AX0, ANT 3S	 28 x 50 x 10							
RF350R ANT 12 RS422  6GT2 801-4AB10, RF350R 6GT2 398-1CC00, ANT 12	 Ø12 x 40					1-10/ 17 (0.04-0.39/ 0.7)		
RF350R ANT 18 RS422  6GT2 801-4AB10, RF350R 6GT2 398-1CA00, ANT 18	 Ø18 x 55				1-9/ 13 (0.04-0.35/ 0.51)	1-12/ 14 (0.04-0.47/ 0.55)		
Accessories		Spacer (6GT2 690-0AL00)	Spacer (6GT2 690-0AL00)	Mounting cover (6GT2 690-0AE00)			Spacer (6GT2 690-0AA00) Mount for quick tag exchange (6GT2 690-0AH00 - long) (6GT2 690-0AH10 - short)	

Operating Distance Range (mm) / Maximum Distance for Stationary Tag (mm)

Operating Distance Range (inch) / Maximum Distance for Stationary Tag (inch)

RF300 Family Matrix (ISO Tags) 13.56 MHz Passive Tags Operational Temperature Range Dimensions(L x W x D) mm Ingress Protection (IP) Rating	Antennas	D126 6GT2 600-0AE00 112 byte EEPROM  -40°C to 100°C Ø 50 x 3,6 IP68	D426 6GT2 600-4AH00 2 kbyte FRAM  -40°C to 100°C Ø 50 x 3,6 IP68	D423 6GT2 600-4AA00 2 kbyte FRAM  -40°C to 100°C Ø 30 x 8 IP68/ IPx9K	D425 6GT2 600-4AG00 2 kbyte FRAM  -40°C to 125°C Ø 24 x 10 IP68/ IPx9K	D428 6GT2 600-4AK00-0AX0 2 kbyte FRAM  -40°C to 125°C Ø18 x 20 IP68/ IPx9K	D139 6GT2 600-0AA10 112 byte EEPROM  -40°C to 220°C Ø 85 x 15 IP68/IPx9K	D339 6GT2600-3AA10 992 byte EEPROM  -40°C to 220°C Ø 85 x 15 IP68/IPx9K
RF350R ANT 30 RS422  6GT2 801-4AB10, RF350R 6GT2 398-1CD00, ANT 30	 Ø30 x 58	0-47/ 60 (0-1.85/ 2.36)	0-45/ 57 (0-1.77/ 2.24)	2-30/ 40 (0.08-1.18/ 1.57)	1-14/ 18 (0.04-0.55/ 0.71)	1-25/ 34 (0.04-0.98/ 1.34)		
RF380R RS422, RS232  6GT2 801-3AB10 6GT2 801-3AB20-0AX1 (Scanmode)	Integrated 160 x 96 x 41	2-145/ 190 (0.08-5.71/ 7.48)	0-155/ 195 (0.0-6.1/ 7.68)	5-75/ 90 (0.2-2.95/ 3.54)	2-32/ 45 (0.08-1.26/ 1.77)	2-70/ 95 (0.08-2.76/ 3.74)	5-160/ 200 (0.20-6.30/ 7.87)	5-160/ 180 (0.20-6.30/ 7.09)
RF382R RS422, RS232  6GT2 801-3AB20-0AX0	Integrated 160 x 96 x 41							
Accessories		Spacer (6GT2 690-0AL00)	Spacer (6GT2 690-0AL00)	Mounting cover (6GT2 690-0AE00)			Spacer (6GT2 690-0AA00) Mount for quick tag exchange (6GT2 690-0AH00 - long) (6GT2 690-0AH10 – short)	

Operating Distance Range (mm) / Maximum Distance for Stationary Tag (mm)

Operating Distance Range (inch) / Maximum Distance for Stationary Tag (inch)

SIMATIC PLC S7-1200

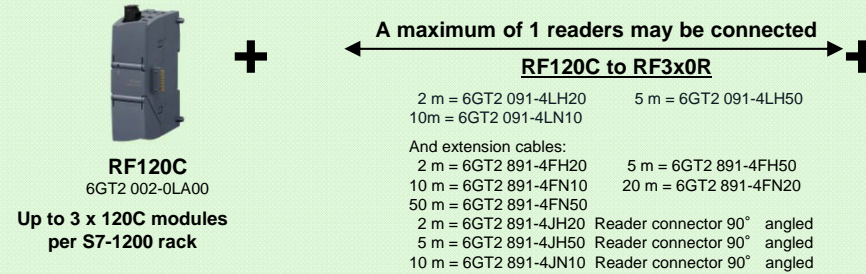

SIMATIC PLC S7-300 Rack or S7-400 via ET 200M (DP-V1/PN-IO)

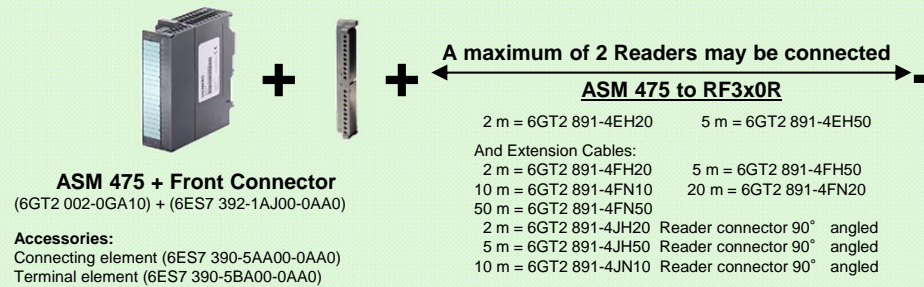

ET 200pro via PROFIBUS or PROFINET or S7 PLC

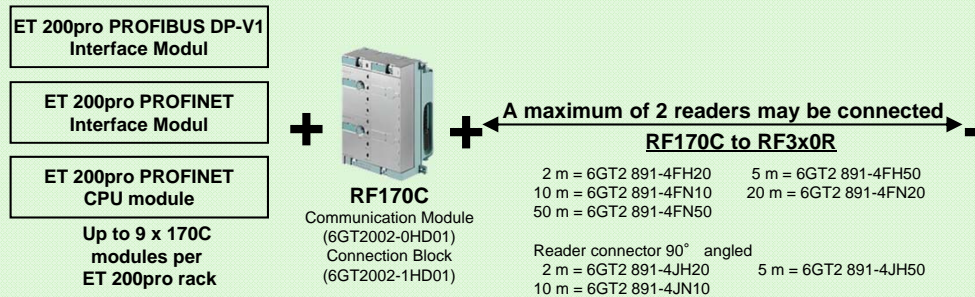

A tool called TIA Selection Tool is available for configuring a complete ET 200pro rack. You will find the tool on the Internet at: <http://www.siemens.com/tia-selection-tool-standalone>.

PROFINET

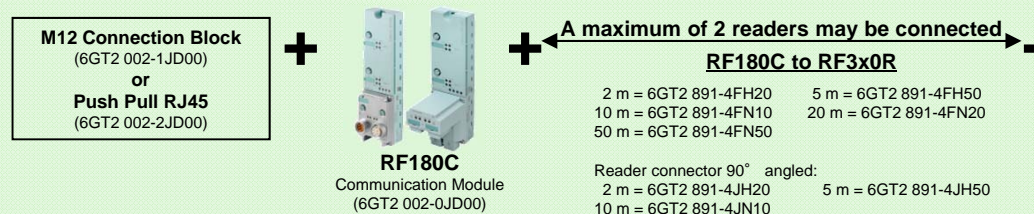

Reader powered through connection cable



- ANT 1**
(6GT2 398-1CB00)
- ANT 3**
(6GT2 398-1CD40-0AX0)
- ANT 3S**
(6GT2 398-1CD60-0AX0)
- ANT 8**
(6GT2 398-1CF10)
- ANT 12**
(6GT2 398-1CC00)
- ANT 18**
(6GT2 398-1CA00)
- ANT 30**
(6GT2 398-1CD00)

Tags



ISO TAGS

- D100** 6GT2 600-0AD10
- D200** 6GT2 600-1AD00-0AX0
- D400** 6GT2 600-4AD00
- D117** 6GT2 600-0AG00
- D421** 6GT2 600-4AE00
- D422** 6GT2 600-4AF00
- D423** 6GT2 600-4AA00
- D124** 6GT2 600-0AC10
- D324** 6GT2 600-3AC00
- D424** 6GT2 600-4AC00
- D425** 6GT2 600-4AG00
- D126** 6GT2 600-0AE00
- D426** 6GT2 600-4AH00
- D127** 6GT2 600-0AF00
- D428** 6GT2 600-4AK00-0AX0
- D139** 6GT2 600-0AA10
- D339** 6GT2 600-3AA10
- D160** 6GT2 600-0AB10
- D460** 6GT2 600-4AB00
- D261** 6GT2 600-1AA01-0AX0
- D165** 6GT2 600-1AB00-0AX0

PROFIBUS

ECOFAST Connection Block
(6ES7 194-3AA00-0AA0)
With Connector for adjusting PROFIBUS address
(6ES7 194-1KB00-0XA0)
or
M12 Connection Block
(6ES7 194-3AA00-0BA0)



ASM 456 (DP-V1)
Communication Module
(6GT2 002-0ED00)
RF160C (DP-V0)
Communication Module
(6GT2 002-0EF00)

A maximum of 2 readers may be connected
ASM 456/ RF160C to RF3x0R

2 m = 6GT2 891-4FH20 5 m = 6GT2 891-4FH50
10 m = 6GT2 891-4FN10 20 m = 6GT2 891-4FN20
50 m = 6GT2 891-4FN50

Reader connector 90° angled
2 m = 6GT2 891-4JH20 5 m = 6GT2 891-4JH50
10 m = 6GT2 891-4JN10

Ethernet TCP/IP



Computers and non Siemens PLCs

Ethernet TP cable through switch. See Page 60 for RF182C Cabling/ Connectors



RF182C
Communication Module
(6GT2 002-0JD10)

Connection Blocks:
M12, 7/8" – 5 pole power (6GT2 002-1JD00)
Push Pull RJ45 (6GT2 002-2JD00)
M12, 7/8" – 4 pole power (6GT2 002-4JD00)

A maximum of 2 readers may be connected
RF182C to RF3X0R

2 m = 6GT2 891-4FH20 5 m = 6GT2 891-4FH50
10 m = 6GT2 891-4FN10 20 m = 6GT2 891-4FN20
50 m = 6GT2 891-4FN50

Reader connector 90° angled
2 m = 6GT2 891-4JH20 5 m = 6GT2 891-4JH50
10 m = 6GT2 891-4JN10

Ethernet/IP

RFID 181EIP
Communication Module
(6GT2 002-0JD20)



Connection Blocks:
M12, 7/8" – 5 pole power (6GT2 002-1JD00)
M12, 7/8" – 4 pole power (6GT2 002-4JD00)

A maximum of 2 readers may be connected
RFID 181EIP to RF3x0R

2 m = 6GT2 891-4FH20 5 m = 6GT2 891-4FH50
10 m = 6GT2 891-4FN10 20 m = 6GT2 891-4FN20
50 m = 6GT2 891-4FN50

Reader connector 90° angled
2 m = 6GT2 891-4JH20 5 m = 6GT2 891-4JH50
10 m = 6GT2 891-4JN10

Reader

powered through connection cable



RF310R RS422
(6GT2 801-1AB10)



RF340R
(6GT2 801-2AB10)



RF350R
(6GT2 801-4AB10)



RF380R
(6GT2 801-3AB10)

- ANT 1**
(6GT2 398-1CB00)
- ANT 3**
(6GT2 398-1CD40-0AX0)
- ANT 3S**
(6GT2 398-1CD60-0AX0)
- ANT 8**
(6GT2 398-1CF10)
- ANT 12**
(6GT2 398-1CC00)
- ANT 18**
(6GT2 398-1CA00)
- ANT 30**
(6GT2 398-1CD00)

Tags



RF320T
(6GT2 800-1CA00)



RF330T
(6GT2 800-5BA00)



RF340T
(8 kb: 6GT2 800-4BB00)
(32 kb: 6GT2 800-5BB00)



RF350T
(6GT2 800-5BD00)



RF360T
(8 kb: 6GT2 800-4AC00)
(32 kb: 6GT2 800-5AC00)



RF370T
(32 kb: 6GT2 800-5BE00)
(64 kb: 6GT2 800-6BE00)



RF380T
(6GT2 800-5DA00)

ISO TAGS

- D100** 6GT2 600-0AD10
- D200** 6GT2 600-1AD00-0AX0
- D400** 6GT2 600-4AD00
- D117** 6GT2 600-0AG00
- D421** 6GT2 600-4AE00
- D422** 6GT2 600-4AF00
- D423** 6GT2 600-4AA00
- D124** 6GT2 600-0AC10
- D324** 6GT2 600-3AC00
- D424** 6GT2 600-4AC00
- D425** 6GT2 600-4AG00
- D126** 6GT2 600-0AE00
- D426** 6GT2 600-4AH00
- D127** 6GT2 600-0AF00
- D428** 6GT2 600-4AK00-0AX0
- D139** 6GT2 600-0AA10
- D339** 6GT2 600-3AA10
- D160** 6GT2 600-0AB10
- D460** 6GT2 600-4AB00
- D261** 6GT2 600-1AA01-0AX0
- D165** 6GT2 600-1AB00-0AX0

RF300 System Interfaces



RS232/RS422



No Driver needed
Scanmode; Read only

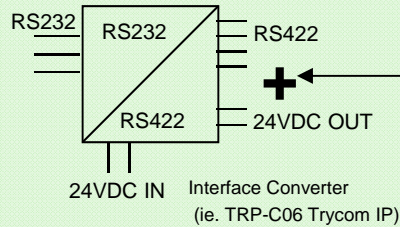

1 Reader per COM port may be connected

Open Wire to RF310R Scanmode
2 m = 6GT2 891-4EH20
5 m = 6GT2 891-4EH50

Reader

with external power supply



RF310R Scanmode
(6GT2 801-1AB20-0AX1)

Tags



RF320T
(6GT2 800-1CA00)



RF330T
(6GT2 800-5BA00)



RF340T
(8 kb: 6GT2 800-4BB00)
(32 kb: 6GT2 800-5BB00)



RF350T
(6GT2 800-5BD00)



RF360T
(8 kb: 6GT2 800-4AC00)
(32 kb: 6GT2 800-5AC00)



RF370T
(32 kb: 6GT2 800-5BE00)
(64 kb: 6GT2 800-6BE00)



RF380T
(6GT2 800-5DA00)

RS232



No Driver needed
Scanmode; Read only

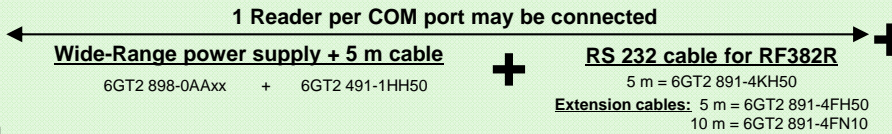

Reader

with external power supply at Y-cable



RF382R
(6GT2 801-3AB20-0AX0)
RF380R
(6GT2801-3AB20-0AX1)

RS232



MOBY API serial on DVD

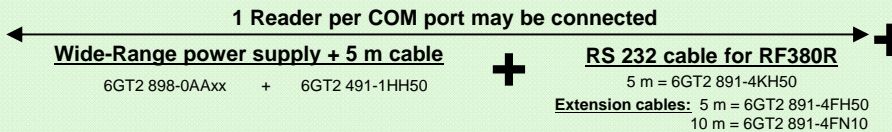

Reader











with external power supply at Y-cable















RF380R
(6GT2 801-3AB10)

ISO TAGS

- D100** 6GT2 600-0AD10
- D200** 6GT2 600-1AD00-0AX0
- D400** 6GT2 600-4AD00
- D117** 6GT2 600-0AG00
- D421** 6GT2 600-4AE00
- D422** 6GT2 600-4AF00
- D423** 6GT2 600-4AA00
- D124** 6GT2 600-0AC10
- D324** 6GT2 600-3AC00
- D424** 6GT2 600-4AC00
- D425** 6GT2 600-4AG00
- D126** 6GT2 600-0AE00
- D426** 6GT2 600-4AH00
- D127** 6GT2 600-0AF00
- D428** 6GT2 600-4AK00-0AX0
- D139** 6GT2 600-0AA10
- D339** 6GT2 600-3AA10
- D160** 6GT2 600-0AB10
- D460** 6GT2 600-4AB00
- D261** 6GT2 600-1AA01-0AX0
- D165** 6GT2 600-1AB00-0AX0

MOBY D Family Matrix 13.56 MHz Passive Tags Operational Temperature Range Dimensions(L x W x D) mm Ingress Protection (IP) Rating	Antennas	D100 6GT2 600-0AD10 112 byte EEPROM  -25°C to 80°C 85,6 x 54 x 0,9 IP68	D200 6GT2 600-1AD00-0AX0 256 byte EEPROM  -20°C to 60°C 85,6 x 54 x 0,8 IP67	D400 6GT2 600-4AD00 2 kbyte FRAM  -20°C to 60°C 85,6 x 54 x 0,8 IP67	D124 6GT2 600-0AC10 112 byte EEPROM  -40°C to 180°C Ø 27 x 4 IP68/ IPx9K	D324 6GT2 600-3AC00 992 byte EEPROM  -40°C to 140°C Ø 27 x 4 IP67	D424 6GT2 600-4AC00 2 kbyte FRAM  -40°C to 100°C Ø 27 x 4 IP67/ IPx9K	D126 6GT2 600-0AE00 112 byte EEPROM  -40°C to 100°C Ø 50 x 3,6 IP68	D426 6GT2 600-4AH00 2 kbyte FRAM  -40°C to 100°C Ø 50 x 3,6 IP68
		SLG D11 ANT D2 RS-232 6GT2 698-1AC00. <hr/> SLG D11S ANT D2 Use Communication Module 6GT2 698-2AC00	ANT D2  6GT2 698-5BB00 75 x 75 x 40				45-70/ 90 (1.44-2.67/ 3.54)	35-60/ 70 (1.38-2.36/ 2.76)	45-70/ 90 (1.77-2.76/ 3.54)
SLG D11 ANT D5 RS-232 6GT2 698-1AC00 <hr/> SLG D11S ANT D5 Use Communication Module 6GT2 698-2AC00	ANT D5  6GT2 698-5AA10 380 x 380 x 110	0- 300/ 380 (0-11.81/ 14.96)	0- 220/ 320 (0-8.66/ 12.60)	0-240/ 300 (0-9.45/ 11.81)	0- 150/220 (0-5.91/ 8.66)	0- 120/ 160 (0- 4.72/ 6.30)	0- 150/ 200 (0-5.91/ 7.87)	0-200/ 260 (0-7.87/ 10.24)	0-180/ 220 (0-7.09/ 8.66)
SLG D12 RS-232 6GT2 601-0AB00	Integrated 160 x 80 x 40	0- 160/ 220 (0- 6.3/ 8.66)	0- 120/ 150 (0- 4.72/ 5.91)	0-100/ 130 (0-4.33/ 5.12)	0- 70/ 100 (0-2.76/ 4.33)	0- 60/ 80 (0- 2.36/ 3.15)	0- 70/ 100 (0- 2.76/ 3.94)	0-100/ 140 (0-4.33/ 5.51)	0-90/ 120 (0-3.54/ 4.72)
SLG D12S Use Communication Module 6GT2 602-0AB10-0AX0 6GT2 602-0AB00		20 mm spacer (6GT2 190-0AA00) Fixing pocket (6GT2 190-0AB00)	20 mm spacer (6GT2 190-0AA00) Fixing pocket (6GT2 190-0AB00)	20 mm spacer (6GT2 190-0AA00) Fixing pocket (6GT2 190-0AB00)	Spacer (6GT2 690-0AK00)	Spacer (6GT2 690-0AK00)	Spacer (6GT2 690-0AK00)	Spacer (6GT2 690-0AL00)	Spacer (6GT2 690-0AL00)
Accessories									

Operating Distance Range (mm) / Maximum Distance for Stationary Tag (mm)
 Operating Distance Range (inch) / Maximum Distance for Stationary Tag (inch)

MOBY D Family Matrix 13.56 MHz Passive Tags Operational Temperature Range Dimensions(L x W x D) mm Ingress Protection (IP) Rating	Antennas	D428	D139	D339	D160	D460	D261	D165
		6GT2 600-4AK00-0AX0 2 kbyte FRAM  -40°C to 125°C Ø18 x 20 IP68/ IPx9K	6GT2 600-0AA10 112 byte EEPROM  -40°C to 220°C Ø 85 x 15 IP68/IPx9K	6GT2600-3AA10 992 byte EEPROM  -40°C to 220°C Ø 85 x 15 IP68/IPx9K	6GT2 600-0AB10 112 byte EEPROM  -40°C to 175°C Ø 16 x 3 IP68/IPx9K	6GT2 600-4AB00 2 kbyte FRAM  -40°C to 100°C Ø 16 x 3 IP67/IPx9K	6GT2 600-1AA01-0AX0 256 byte EEPROM  -25°C to 85°C 55 x 55 x 0,3 IP65	6GT2 600-1AB00-0AX0 112 byte EEPROM  -25°C to 85°C 86 x 54 x 0,3 IP65
SLG D11 ANT D2 RS-232 6GT2 698-1AC00  SLG D11S ANT D2 Use Communication Module 6GT2 698-2AC00	ANT D2  6GT2 698-5BB00 75 x 75 x 40				35-55/ 65 (1.38-2.16/ 2.56)	30-50/ 60 (1.18-1.97/ 2.36)		
SLG D11 ANT D5 RS-232 6GT2 698-1AC00  SLG D11S ANT D5 Use Communication Module 6GT2 698-2AC00	ANT D5  6GT2 698-5AA10 380 x 380 x 110	0- 70/ 100 (0-2.76/ 3.94)	0- 280/ 350 (0- 11.02/ 13.78)	0-180/ 220 (0-7.09/ 8.66)	0- 75/ 110 (0-2.95/ 4.33)	0- 70/ 100 (0-2.76/ 3.94)	0-200/280 (0-7.87 / 11.02)	0-220/300 (0-8.66 / 11.81)
SLG D12 RS-232 6GT2 601-0AB00  SLG D12S Use Communication Module 6GT2 602-0AB10-0AX0 6GT2 602-0AB00 	Integrated 160 x 80 x 40	0- 40/ 60 (0- 1.57/ 2.36)	0- 120/ 150 (0- 4.72/ 5.91)	0-90/ 110 (0-3.54/ 4.33)	0- 45/ 65 (0-1.77/ 2.56)	0- 40/ 60 (0-1.57/ 2.36)	0-100/140 (0-3.94 / 5.51)	0-120/150 (0-4.72 / 5.91)
Accessories			Spacer (6GT2 690-0AA00) Mount for quick tag exchange (6GT2 690-0AH00 - long) (6GT2 690-0AH10 - short)		Spacer (6GT2 690-0AG00)	Spacer (6GT2 690-0AG00)		

Operating Distance Range (mm) / Maximum Distance for Stationary Tag (mm)

Operating Distance Range (inch) / Maximum Distance for Stationary Tag (inch)

SIMATIC PLC

S7-300 Rack or
S7-400 via ET 200M
(DP-V1/PN-IO)

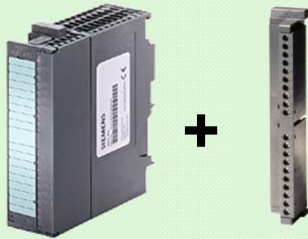

ASM 475 + Front Connector
(6GT2 002-0GA10) + (6ES7 392-1AJ00-0AA0)

Accessories:
Connecting element (6ES7 390-5AA00-0AA0)
Terminal element (6ES7 390-5BA00-0AA0)

← **A maximum of 2 SLGs may be connected** →
ASM 475 to SLG D12S
2 m = 6GT2 891-4EH20 5 m = 6GT2 891-4EH50

And Extension Cables:
2 m = 6GT2 891-4FH20 5 m = 6GT2 891-4FH50
10 m = 6GT2 891-4FN10 20 m = 6GT2 891-4FN20
50 m = 6GT2 891-4FN50
2 m = 6GT2 891-4JH20 Reader connector 90° angled
5 m = 6GT2 891-4JH50 Reader connector 90° angled
10 m = 6GT2 891-4JN10 Reader connector 90° angled

← **A maximum of 2 SLGs may be connected** →
ASM 475 to SLG
5 m = 6GT2 491-4EH50
20 m = 6GT2 491-4EN20
50 m = 6GT2 491-4EN50

PROFINET

M12 Connection Block
(6GT2 002-1JD00)
or
Push Pull RJ45
(6GT2 002-2JD00)



RF180C
Communication Module
(6GT2 002-0JD00)

← **A maximum of 2 SLGs may be connected** →
RF180C to SLG

2 m = 6GT2 691-4FH20
And Extension Cables:
2 m = 6GT2 891-4FH20 5 m = 6GT2 891-4FH50
10 m = 6GT2 891-4FN10 20 m = 6GT2 891-4FN20
50 m = 6GT2 891-4FN50

← **A maximum of 2 SLGs may be connected** →
RF180C to SLG D12S

2 m = 6GT2 891-4FH20 5 m = 6GT2 891-4FH50
10 m = 6GT2 891-4FN10 20 m = 6GT2 891-4FN20
50 m = 6GT2 891-4FN50
Reader connector 90° angled
2 m = 6GT2 891-4JH20 5 m = 6GT2 891-4JH50
10 m = 6GT2 891-4JN10

Reader

powered through connection cable



SLG D12S
(6GT2 602-0AB10-0AX0)

Reader

with external power supply



SLG D11S
(6GT2 698-2AC00)

**Wide- Range
power supply**

EU connector
(6GT2 898-0AA00)

UK connector
(6GT2 898-0AA10)

US connector
(6GT2 898-0AA20)

**5 m cable
for 24 V**
(6GT2 491-1HH50)

ANT D2
(6GT2 698-5BB00)
ANT D5
(6GT2 698-5AA10)



SLG D12S
(6GT2 602-0AB00)

Reader

powered through connection cable



SLG D12S
(6GT2 602-0AB10-0AX0)

Tags



MDS D100
(6GT2 600-0AD10)
MDS D200
(6GT2 600-1AD00 -0AX0)
MDS D400
(6GT2 600-4AD00)



MDS D124
(6GT2 600-0AC10)
MDS 324
(6GT2 600-3AC00)
MDS 424
(6GT2 600-4AC00)



MDS D126
(6GT2 600-0AE00)
MDS D426
(6GT2 600-4AH00)



MDS D139
(6GT2 600-0AA10)

MDS D339
(6GT2 600-3AA10)



MDS D160
(6GT2 600-0AB10)

MDS D460
(6GT2 600-4AB00)



MDS D165
(6GT2 600-1AB00-0AX0)

MDS D261
(6GT2 600-1AA01-0AX0)



MDS D428
(6GT2 600-4AK00-0AX0)

PROFIBUS

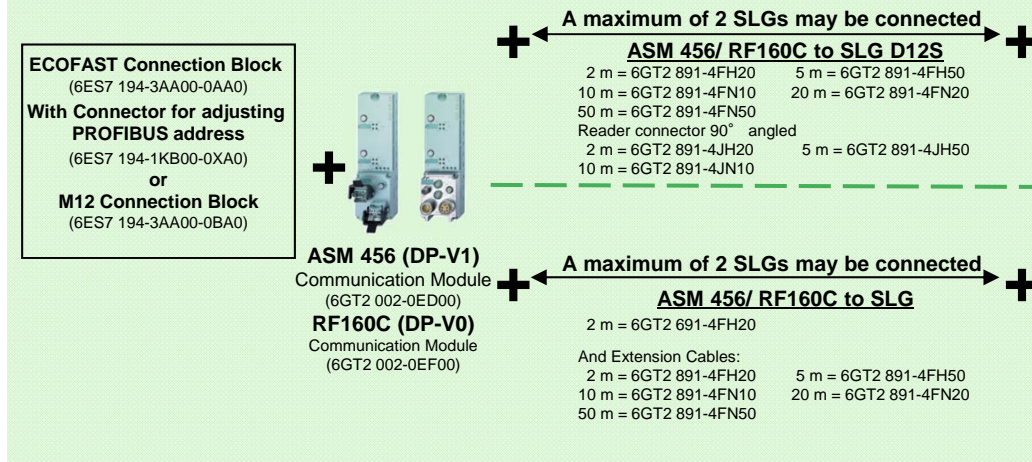

ET 200pro via PROFIBUS or PROFINET or S7 PLC

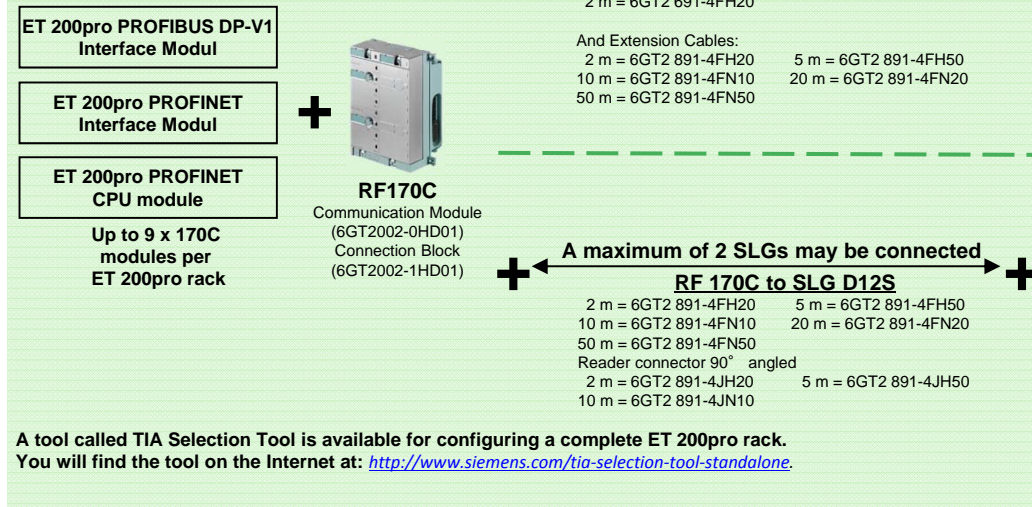

Reader powered through connection cable



SLG D12S
(6GT2 602-0AB10-0AX0)

Reader with external power supply



SLG D11S
(6GT2 698-2AC00)

Wide- Range power supply

EU connector
(6GT2 898-0AA00)

UK connector
(6GT2 898-0AA10)

US connector
(6GT2 898-0AA20)

5 m cable for 24 V
(6GT2 491-1HH50)

ANT D2
(6GT2 698-5BB00)

ANT D5
(6GT2 698-5AA10)

Reader powered through connection cable



SLG D12S
(6GT2 602-0AB10-0AX0)

Tags



- MDS D100**
(6GT2 600-0AD10)
- MDS D200**
(6GT2 600-1AD00 -0AX0)
- MDS D400**
(6GT2 600-4AD00)



- MDS D124**
(6GT2 600-0AC10)
- MDS 324**
(6GT2 600-3AC00)
- MDS 424**
(6GT2 600-4AC00)



- MDS D126**
(6GT2 600-0AE00)
- MDS D426**
(6GT2 600-4AH00)



- MDS D139**
(6GT2 600-0AA10)

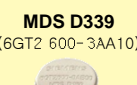

- MDS D339**
(6GT2 600-3AA10)



- MDS D160**
(6GT2 600-0AB10)

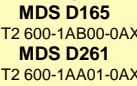

- MDS D460**
(6GT2 600-4AB00)



- MDS D165**
(6GT2 600-1AB00-0AX0)
- MDS D261**
(6GT2 600-1AA01-0AX0)

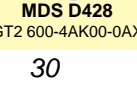

- MDS D428**
(6GT2 600-4AK00-0AX0)

Ethernet/IP

Connection Blocks:
 M12, 7/8" – 5 pole power (6GT2 002-1JD00)
 M12, 7/8" – 4 pole power (6GT2 002-4JD00)



RFID 181EIP
Communication Module
(6GT2 002-0JD20)

+ ← **A maximum of 2 SLGs may be connected** → +

RFID 181EIP to SLG D12S

2 m = 6GT2 891-4FH20	5 m = 6GT2 891-4FH50
10 m = 6GT2 891-4FN10	20 m = 6GT2 891-4FN20
50 m = 6GT2 891-4FN50	
Reader connector 90° angled	
2 m = 6GT2 891-4JH20	5 m = 6GT2 891-4JH50
10 m = 6GT2 891-4JN10	

+ ← **A maximum of 2 SLGs may be connected** → +

RFID 181EIP to SLG

2 m = 6GT2 691-4FH20

And Extension Cables:
 or basic cable for 6GT2 602-0AB10-0AX0
 2 m = 6GT2 891-4FH20 5 m = 6GT2 891-4FH50
 10 m = 6GT2 891-4FN10 20 m = 6GT2 891-4FN20
 50 m = 6GT2 891-4FN50

Ethernet TCP/IP

Ethernet TP cable through switch. See Page 60 for RF182C Cabling/ Connectors



RF182C
Communication Module
(6GT2 002-0JD10)

+ ← **A maximum of 2 SLGs may be connected** → +

RF182C to SLG

2 m = 6GT2 691-4FH20

And Extension Cables:
 2 m = 6GT2 891-4FH20 5 m = 6GT2 891-4FH50
 10 m = 6GT2 891-4FN10 20 m = 6GT2 891-4FN20
 50 m = 6GT2 891-4FN50

+ ← **A maximum of 2 SLGs may be connected** → +

RF182C to SLG D12S

2 m = 6GT2 891-4FH20	5 m = 6GT2 891-4FH50
10 m = 6GT2 891-4FN10	20 m = 6GT2 891-4FN20
50 m = 6GT2 891-4FN50	
Reader connector 90° angled	
2 m = 6GT2 891-4JH20	5 m = 6GT2 891-4JH50
10 m = 6GT2 891-4JN10	

Connection Blocks:
 M12, 7/8" – 5 pole power (6GT2 002-1JD00)
 Push Pull RJ45 (6GT2 002-2JD00)
 M12, 7/8" – 4-pin power (6GT2 002-4JD00)

Computers and non Siemens PLCs

Reader
powered through connection cable



SLG D12S
(6GT2 602-0AB10-0AX0)

Reader
with external power supply

Wide- Range power supply

EU connector
(6GT2 898-0AA00)

UK connector
(6GT2 898-0AA10)

US connector
(6GT2 898-0AA20)

5 m cable for 24 V
(6GT2 491-1HH50)



SLG D11S
(6GT2 698-2AC00)

ANT D2
(6GT2 698-5BB00)

ANT D5
(6GT2 698-5AA10)

Reader
powered through connection cable



SLG D12S
(6GT2 602-0AB10-0AX0)

Tags



MDS D100
(6GT2 600-0AD10)

MDS D200
(6GT2 600-1AD00 -0AX0)

MDS D400
(6GT2 600-4AD00)



MDS D124
(6GT2 600-0AC10)

MDS 324
(6GT2 600-3AC00)

MDS 424
(6GT2 600-4AC00)



MDS D126
(6GT2 600-0AE00)

MDS D426
(6GT2 600-4AH00)



MDS D139
(6GT2 600-0AA10)

MDS D339
(6GT2 600-3AA10)



MDS D160
(6GT2 600-0AB10)

MDS D460
(6GT2 600-4AB00)



MDS D165
(6GT2 600-1AB00-0AX0)

MDS D261
(6GT2 600-1AA01-0AX0)



MDS D428
(6GT2 600-4AK00-0AX0)

RS232

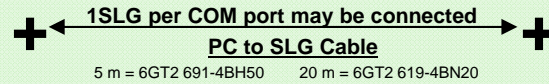

1. C++/C/VB API on SIMATIC RF DVD
2. Open ASCII protocol

Reader

with external power supply

Wide- Range power supply

EU connector
(6GT2 898-0AA00)

UK connector
(6GT2 898-0AA10)

US connector
(6GT2 898-0AA20)

5 m cable for 24 V
(6GT2 491-1HH50)



SLG D11
(6GT2 698-1AC00)



SLG D12
(6GT2 601-0AB00)

ANT D2
(6GT2 698-5BB00)
ANT D5
(6GT2 698-5AA10)

Tags



- MDS D100**
(6GT2 600-0AD10)
- MDS D200**
(6GT2 600-1AD00 -0AX0)
- MDS D400**
(6GT2 600-4AD00)



- MDS D124**
(6GT2 600-0AC10)
- MDS 324**
(6GT2 600-3AC00)
- MDS 424**
(6GT2 600-4AC00)



- MDS D126**
(6GT2 600-0AE00)
- MDS D426**
(6GT2 600-4AH00)



- MDS D139**
(6GT2 600-0AA10)

- MDS D339**
(6GT2 600-3AA10)















- MDS D160**
(6GT2 600-0AB10)
- MDS D460**
(6GT2 600-4AB00)















- MDS D165**
(6GT2 600-1AB00-0AX0)
- MDS D261**
(6GT2 600-1AA01-0AX0)



- MDS D428**
(6GT2 600-4AK00-0AX0)

RF600 Family Matrix Labels 865-868 MHz (ETSI) 902-928 MHz (FCC) Passive Tags (w/ Gen2 protocol) Operational Temperature Range Dimensions (L x W x D) mm Ingress Protection (IP) Rating	Antennas	RF630L 6GT2 810-2AB00 6GT2 810-2AB01 96 bit EPC 6GT2 810-2AB02-0AX0 96/240 bits EPC, 64 byte  -40°C to 80°C Different shapes IP65	RF630L 6GT2 810-2AB03 96/240 bit EPC, 64 byte  -40°C to 80°C 54 x 34 IP65	RF630L 6GT2 810-2AB04 256 bits EPC, 64 byte  -25°C to 160°C 74 x 27 x 0,3	RF640L 6GT2810-2AC00 (ETSI) 6GT2810-2AC10 (FCC) 96/496 bit EPC, 64 byte  -25°C to 85°C 59 x 22,5 x 1,6 IP67 (on metal use)	RF680L 6GT2 810-2AG80 96/240 bit EPC, 64 byte  -40°C to 230°C 89 x 54 x 0,3 IP65	RF690L 6GT2810-2AG00 (ETSI) 6GT2810-2AG10 (FCC) 96/496 bit EPC, 64 byte  -25°C to 230°C 88 x 25 x 1,6 (ETSI) 75 x 25 x 1,6 (FCC) IP67
RF620R (internal antenna used)  6GT2 811-5BA00-0AA0 (ETSI) 6GT2 811-5BA00-1AA0 (FCC) 6GT2 811-5BA00-2AA1 (CMIIT)	Integrated 260 x 193 x 52	5,0 (197)	3,0 (118)	3,5 (140)	2,0 (80)	2,5 (98)	2,5 (100)
RF630R  6GT2 811-4AA00-0AA1 (ETSI) 6GT2 811-4AA00-1AA1 (FCC) 6GT2 811-4AA00-2AA1 (CMIIT)	RF620A  75 x 75 x 20	1,6 (63)	1,0 (40)	0,4 (15)	0,35 (14)	0,8 (32)	0,7 (28)
RF620R (external antenna used) 	RF640A  185 x 185 x 45	4,5 (177)	2,8 (110)	2,5 (100)	2,0 (80)	2,2 (87)	3,0 (120)
Antennas: 6GT2 812-1EA00, RF620A, linear, (ETSI) 6GT2 812-1EA01, RF620A, linear, (FCC, CMIIT) 6GT2 812-0GA08, RF640A, circular, (all frequencies) 6GT2 812-1GA08, RF642A, linear, (all frequencies) 6GT2 812-0AA00, RF660A, circular, (ETSI) 6GT2 812-0AA01, RF660A, circular, (FCC, CMIIT)	RF642A  185 x 185 x 45	5,5 (217)	3,5 (138)	3,5 (140)	2,5 (100)	2,8 (110)	4,5 (177)
Accessories	Antenna mounting kit RF640A/ RF642A/ RF660A (6GT2 890-0AA00)						













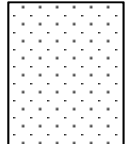

Maximum operating distance (m) and maximum operating distance (inch)
 pay attention to the system manual for range overshoot

RF600 Family Matrix Industrial Tags 865-868 MHz (ETSI) 902-928 MHz (FCC) Passive Tags (w/ Gen2 protocol) Operational Temperature Range Dimensions (L x W x D) mm Ingress Protection (IP) Rating	Antennas	RF610T 6GT2 810-2BB80 6GT2 810-2BB80-0AX1* 96/240 bit EPC, 64 byte  -40°C to 85°C 86 x 54 x 0,4 IP67	RF620T 6GT2 810-2HC81 96/128 bit EPC, 64 byte  -40°C to 85°C 127 x 38 x 6 IP67	RF625T 6GT2 810-2EE00 (ETSI) 6GT2 810-2EE01 (FCC) 96/128 bit EPC, 64 byte  -40°C to 125°C Ø 30 x 8 IP68/ IPx9K	RF630T 6GT2 810-2EC00 (ETSI) 6GT2 810-2EC10 (FCC) 96/240 bit EPC, 64 byte  -40°C to 125°C Ø 21x 20 IP68/ IPx9K	RF640T 6GT2 810-2DC00 (ETSI)* 6GT2 810-2DC10 (FCC) 96/240 bit EPC, 64 byte  -40°C to 125°C Ø 50 x 8 IP68/ IPx9K	RF680T 6GT2 810-2HG80 96/240 bit EPC, 64 byte  -40°C to 220°C 130 x 32 x 15 IP68/ IPx9K
RF620R (internal antenna used)  6GT2 811-5BA00-0AA0 (ETSI) 6GT2 811-5BA00-1AA0 (FCC) 6GT2 811-5BA00-2AA1 (CMIIT)	Integrated 260 x 193 x 52	3,0 (118)	5,0 (197)	1,0 (40)	0,8 (32)	2,5 (98)	2,5 (98)
RF630R  6GT2 811-4AA00-0AA1 (ETSI) 6GT2 811-4AA00-1AA1 (FCC) 6GT2 811-4AA00-2AA1 (CMIIT)	RF620A  75 x 75 x 20	1,0 (40)	1,6 (63)	0,3 (12)	0,3 (12)	0,8 (32)	0,8 (32)
RF620R (external antenna used)  6GT2 811-5BA00-0AA0 (ETSI) 6GT2 811-5BA00-1AA0 (FCC) 6GT2 811-5BA00-2AA1 (CMIIT)	RF640A  185 x 185 x 45	2,8 (110)	4,5 (178)	0,8 (32)	0,7 (28)	2,2 (87)	2,2 (87)
Antennas: 6GT2 812-1EA00, RF620A, linear, (ETSI) 6GT2 812-1EA01, RF620A, linear, (FCC, CMIIT) 6GT2 812-0GA08, RF640A, circular, (all frequencies) 6GT2 812-1GA08, RF642A, linear, (all frequencies) 6GT2 812-0AA00, RF660A, circular, (ETSI) 6GT2 812-0AA01, RF660A, circular, (FCC, CMIIT)	RF642A  185 x 185 x 45	3,5 (138)	5,5 (217)	1,1 (43)	0,8 (32)	2,8 (110)	2,8 (110)
Accessories	Antenna mounting kit RF640A/ RF642A/ RF660A (6GT2 890-0AA00)	20 mm spacer (6GT2 190-0AA00) Fixing pocket (6GT2 190-0AB00)	spacer (6GT2 898-2AA00)				











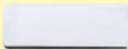
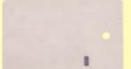

Maximum operating distance (m) and maximum operating distance (inch)

pay attention to the system manual for range overshoot











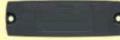



SIMATIC Ident Configuration Guide

RF600 Family Matrix Labels 865-868 MHz (ETSI) 902-928 MHz (FCC) Passive Tags (with Gen2 protocol) Operational Temperature Range Dimensions (L x W x D) mm Ingress Protection (IP) Rating	Antennas	RF622L 6GT2 810-4AC80 496 bits EPC 3424 byte  -40°C to 85°C 90 x 18 x 0,5 IP64	RF630L 6GT2 810-2AB00 6GT2 810-2AB01 96 bits EPC 6GT2 810-2AB02-0AX0 96/240 bits EPC, 64 byte  -40°C to 80°C different shapes IP65	RF630L 6GT2 810-2AB03 96/240 bits EPC, 64 byte  -40°C to 80°C 54 x 34 IP65	RF630L 6GT2 810-2AB04 256 bits EPC, 64 byte  -25°C to 160°C 74 x 27 IP60	RF630L 6GT2810-2AC82 128 bits EPC  -25°C to 95°C 45 x 20 IP67
RF685R (IP65) (internal antenna used) 6GT2811-6CA10-0AA0 (ETSI) 6GT2811-6CA10-1AA0 (FCC) 6GT2811-6CA10-2AA0 (CMIIT) 6GT2811-6CA10-4AA0 (ARIB) 	Integrated 260 x 193 x 52	3,0 (118)	7,0 (276)	4,0 (157)	4,0 (157)	
RF685R (IP65) (external antenna used) 6GT2811-6CA10-0AA0 (ETSI) 6GT2811-6CA10-1AA0 (FCC) 6GT2811-6CA10-2AA0 (CMIIT) 6GT2811-6CA10-4AA0 (ARIB) 	RF620A  75 x 75 x 20	0,4 (16)	2,2 (87)	1,4 (55)	0,4 (16)	
	RF640A  185 x 185 x 45	2,5 (98)	6,0 (236)	4,0 (157)	3,0 (118)	
RF680R (IP65) 6GT2811-6AA10-0AA0 (ETSI) 6GT2811-6AA10-1AA0 (FCC) 6GT2811-6AA10-2AA0 (CMIIT) 6GT2811-6AA10-4AA0 (ARIB) 	RF642A  185 x 185 x 45	3,0 (118)	8,0 (315)	5,0 (197)	4,0 (157)	
RF650R (IP30) 6GT2811-6AB20-0AA0 (ETSI) 6GT2811-6AB20-1AA0 (FCC) 6GT2811-6AB20-2AA0 (CMIIT) 6GT2811-6AB20-4AA0 (ARIB) 	RF650A  198 x 198 x 60	4,0 (157)	6,5 (256)	4,0 (157)	3,0 (118)	
Antennas: 6GT2 812-1EA00, RF620A, linear, (ETSI) 6GT2 812-1EA01, RF620A, linear, (FCC, CMIIT, ARIB) 6GT2 812-0GA08, RF640A, circular, (all readers) 6GT2 812-1GA08, RF642A, linear, (all readers) 6GT2 812-0GB08 RF650A, circular, (all readers) 6GT2 812-0AA00, RF660A, circular, (ETSI) 6GT2 812-0AA01, RF660A, circular, (FCC, CMIIT, ARIB) 6GT2 812-2GB08 RF680A, switchable, (all readers)	RF660A  313 x 313 x 80	3,0 (118)	8,0 (315)	5,0 (197)	4,0 (157)	
Accessories	Antenna mounting kit for all antennas except RF620A (6GT2 890-0AA00)					

Data not yet available,
 Ask Siemens support

RF600 Family Matrix Labels 865-868 MHz (ETSI) 902-928 MHz (FCC) Passive Tags (with Gen2 protocol) Operational Temperature Range Dimensions (L x W x D) mm Ingress Protection (IP) Rating	Antennas	RF630L 6GT2810-2AE81-0AX1 128 bits EPC  -40°C to 160°C 90 x 30 IP67	RF630L 6GT2810-2AE80-0AX2 Bis zu 480 bits EPC, 64/8 Byte  -25°C to 130°C 105 x 25 IP67	RF640L 6GT2810-2AC00 6GT2810-2AC10 96/496 bit EPC, 64 byte  -25°C to 85°C 59 x 22,5 x 1,6 IP67 (on metal use)	RF680L 6GT2 810-2AG80 96/240 bits EPC, 64 byte  -40°C to 230°C 89 x 54 x 0,3 IP65	RF690L 6GT2810-2AG00 6GT2810-2AG10 96/496 bit EPC, 64 byte  -25°C to 230°C 88 x 25 x 1,6 75 x 25 x 1,6 IP67		
RF685R (IP65) (internal antenna used) 6GT2811-6CA10-0AA0 (ETSI) 6GT2811-6CA10-1AA0 (FCC) 6GT2811-6CA10-2AA0 (CMIIT) 6GT2811-6CA10-4AA0 (ARIB) 	Integrated 260 x 193 x 52	Data not yet available, Ask Siemens support	Data not yet available, Ask Siemens support	3,0 (118)	3,5 (137)	4,0 (157)		
RF685R (IP65) (external antenna used) 6GT2811-6CA10-0AA0 (ETSI) 6GT2811-6CA10-1AA0 (FCC) 6GT2811-6CA10-2AA0 (CMIIT) 6GT2811-6CA10-4AA0 (ARIB) 	RF620A  75 x 75 x 20					0,35 (14)	1,1 (43)	0,75 (30)
	RF640A  185 x 185 x 45					2,0 (79)	3,1 (122)	3,0 (118)
RF680R (IP65) 6GT2811-6AA10-0AA0 (ETSI) 6GT2811-6AA10-1AA0 (FCC) 6GT2811-6AA10-2AA0 (CMIIT) 6GT2811-6AA10-4AA0 (ARIB) 	RF642A  185 x 185 x 45					2,5 (98)	4,0 (157)	4,5 (178)
RF650R (IP30) 6GT2811-6AB20-0AA0 (ETSI) 6GT2811-6AB20-1AA0 (FCC) 6GT2811-6AB20-2AA0 (CMIIT) 6GT2811-6AB20-4AA0 (ARIB) 	RF650A  198 x 198 x 60					2,0 (79)	4,5 (178)	5,1 (201)
Antennas: 6GT2 812-1EA00, RF620A, linear, (ETSI) 6GT2 812-1EA01, RF620A, linear, (FCC, CMIIT, ARIB) 6GT2 812-0GA08, RF640A, circular, (all readers) 6GT2 812-1GA08, RF642A, linear, (all readers) 6GT2 812-0GB08 RF650A, circular, (all readers) 6GT2 812-0AA00, RF660A, circular, (ETSI) 6GT2 812-0AA01, RF660A, circular, (FCC, CMIIT, ARIB) 6GT2 812-2GB08 RF680A, switchable, (all readers)	RF660A  313 x 313 x 80					3,5 (137)	4,0 (157)	5,0 (197)
Accessories	Antenna mounting kit for all antennas except RF620A (6GT2.890-0AA00)							

Maximum operating distance (m) and maximum operating distance (inch)
 pay attention to the system manual for range overshoot
 SIMATIC Ident Configuration Guide

RF600 Family Matrix Industrial Tags 865-868 MHz (ETSI) 902-928 MHz (FCC) Passive Tags (with Gen2 protocol) Operational Temperature Range Dimensions (L x W x D) mm Ingress Protection (IP) Rating	Antennas	RF610T 6GT2 810-2BB80 6GT2 810-2BB80-0AX1* 96/240 bit EPC, 64 byte  -40°C to 85°C 86 x 54 x 0,4 IP67	RF620T 6GT2 810-2HC81 96/128 bit EPC, 64 byte  -40°C to 85°C 127 x 38 x 6 IP67	RF622T 6GT2 810-4HC 80 496 bits EPC 3424 byte  -40°C to 85°C 120 x 30 x 6,5 IP67	RF625T 6GT2 810-2EE00 (ETSI) 6GT2 810-2EE01 (FCC) 96/128 bit EPC, 64 byte  -40°C to 125°C Ø 30 x 8 IP68/ IPx9K	RF630T 6GT2 810-2EC00 (ETSI) 6GT2 810-2EC10 (FCC) 96/240 bit EPC, 64 byte  -40°C to 125°C Ø 21x 20 IP68/ IPx9K	RF640T 6GT2 810-2DC00 (ETSI) 6GT2 810-2DC10 (FCC) 96/240 bit EPC, 64 byte  -40°C to 125°C Ø 50 x 8 IP68/ IPx9K	RF680T 6GT2 810-2HG80 96/240 bit EPC, 64 byte  -40°C to 220°C 130 x 32 x 15 IP68/ IPx9K
RF685R (IP65) (internal antenna used) 6GT2811-6CA10-0AA0 (ETSI) 6GT2811-6CA10-1AA0 (FCC) 6GT2811-6CA10-2AA0 (CMIIT) 6GT2811-6CA10-4AA0 (ARIB) 	Integrated 260 x 193 x 52	4,5 (177)	7,0 (276)	3,0 (197)	1,5 (59)	2,0 (79)	4,0 (157)	4,0 (157)
RF685R (IP65) (external antenna used) 6GT2811-6CA10-0AA0 (ETSI) 6GT2811-6CA10-1AA0 (FCC) 6GT2811-6CA10-2AA0 (CMIIT) 6GT2811-6CA10-4AA0 (ARIB) 	RF620A  75 x 75 x 20	1,4 (55)	1,35 (51)	0,4 (15)	0,4 (15)	0,3 (12)	1,1 (43)	1,1 (43)
	RF640A  185 x 185 x 45	4,0 (157)	6,0 (236)	2,5 (98)	1,2 (47)	0,9 (35)	3,0 (118)	3,0 (118)
RF680R (IP65) 6GT2811-6AA10-0AA0 (ETSI) 6GT2811-6AA10-1AA0 (FCC) 6GT2811-6AA10-2AA0 (CMIIT) 6GT2811-6AA10-4AA0 (ARIB) 	RF642A  185 x 185 x 45	5,0 (197)	8,0 (315)	3,0 (118)	1,5 (59)	1,2 (47)	4,0 (157)	4,0 (157)
RF650R (IP30) 6GT2811-6AB20-0AA0 (ETSI) 6GT2811-6AB20-1AA0 (FCC) 6GT2811-6AB20-2AA0 (CMIIT) 6GT2811-6AB20-4AA0 (ARIB) 	RF650A  198 x 198 x 60	3,7 (146)	8,0 (315)	3,1 (122)	1,3 (51)	2,0 (79)	4,2 (165)	5,0 (197)
Antennas: 6GT2 812-1EA00, RF620A, linear, (ETSI) 6GT2 812-1EA01, RF620A, linear, (FCC, CMIIT, ARIB) 6GT2 812-0GA08, RF640A, circular, (all readers) 6GT2 812-1GA08, RF642A, linear, (all readers) 6GT2 812-0GB08, RF650A, circular, (all readers) 6GT2 812-0AA00, RF660A, circular, (ETSI) 6GT2 812-0AA01, RF660A, circular, (FCC, CMIIT, ARIB) 6GT2 812-2GB08, RF680A, switchable, (all readers)	RF660A  313 x 313 x 80	5,0 (197)	8,0 (315)	3,0 (118)	1,5 (60)	1,2 (47)	4,0 (157)	4,0 (157)
Accessories	Antenna mounting kit for all antennas except RF620A (6GT2 890-0AA00)	20 mm spacer (6GT2 190-0AA00) Fixing pocket (6GT2 190-0AB00)	spacer (6GT2 898-2AA00)	spacer (6GT2 898-3AA00)				

Maximum operating distance (m) and maximum operating distance (inch)

pay attention to the system manual for range overshoot

SIMATIC Ident Configuration Guide

SIMATIC PLC S7-1200

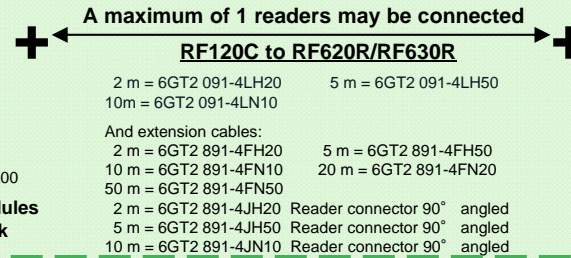

SIMATIC PLC S7-300 Rack or S7-400 via ET 200M (DP-V1/PN-IO)

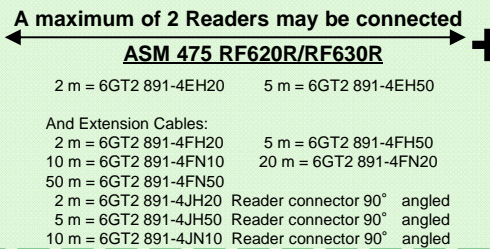
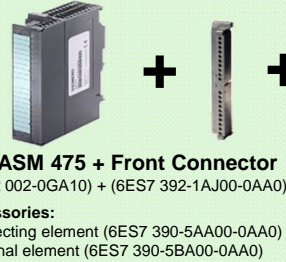

PROFINET

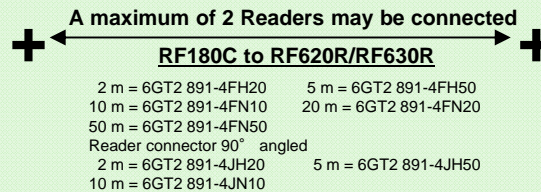
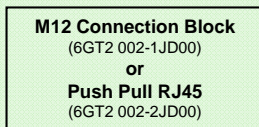

ET 200pro via PROFIBUS or PROFINET or S7 PLC

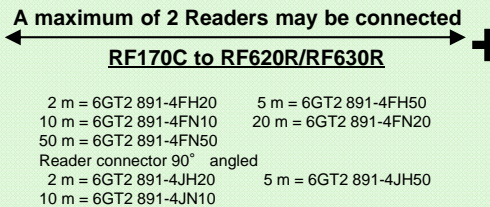
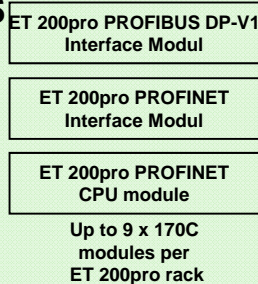

Reader

powered through connection cable



RF620R
(Internal antenna used)
6GT2 811-5BA00-0AA0 (ETSI)
6GT2 811-5BA00-1AA0 (FCC)
6GT2 811-5BA00-2AA1 (CMIIT)



RF620A
(external antenna used)
6GT2 811-5BA00-0AA0 (ETSI)
6GT2 811-5BA00-1AA0 (FCC)
6GT2 811-5BA00-2AA1 (CMIIT)



RF630R
6GT2 811-4AA00-0AA1 (ETSI)
6GT2 811-4AA00-1AA1 (FCC)
6GT2 811-4AA00-2AA1 (CMIIT)

RF620A
6GT2812-1EA00, ETSI
6GT2812-1EA01, FCC, CMIIT

Antenna Cable

1m	= 6GT2815-0BH10
3m	= 6GT2 815-0BH30
5m, flex	= 6GT2 815-2BH50
10m, 2dB	= 6GT2 815-1BN10

RF640A
6GT2 812-0GA08

RF642A
6GT2 812-1GA08

RF660A
6GT2 812-0AA00, ETSI
6GT2 812-0AA01, FCC, CMIIT

Antenna Mounting kit
6GT2 890-0AA00

Antenna Cable

1m	= 6GT2815-0BH10
3m	= 6GT2 815-0BH30
5m, flex	= 6GT2 815-2BH50
10m, 2dB	= 6GT2 815-1BN10
10m, 4dB	= 6GT2 815-0BN10
15m, flex	= 6GT2 815-2BN15
20m	= 6GT2 815-0BN20
40m	= 6GT2 815-0BN40

Antenna attenuator

3 dB	= 6GT2 890-0BB00
6 dB	= 6GT2 890-0BB10
10 dB	= 6GT2 890-0BB20

Labels

RF630L
6GT2 810-2AB00
6GT2 810-2AB01
6GT2 810-2AB03
6GT2810-2AB04

RF640L
6GT2 810-2AC00 (ETSI)
6GT2 810-2AC10 (FCC)

RF680L
6GT2 810-2AG80

RF690L
6GT2 810-2AG00 (ETSI)
6GT2 810-2AG10 (FCC)

Tags

RF610T
6GT2 810-2BB80
6GT2 810-2BB80-0AX1

RF620T
6GT2 810-2HC81

RF625T
6GT2 810-2EE00 (ETSI)
6GT2 810-2EE01 (FCC)

RF630T
6GT2 810-2EC00 (ETSI)
6GT2 810-2EC10 (FCC)

RF640T Gen2
6GT2 810-2DC00 (ETSI)
6GT2 810-2DC10 (FCC)

RF680T
6GT2 810-2HG80

A tool called TIA Selection Tool is available for configuring a complete ET 200pro rack. You will find the tool on the Internet at: <http://www.siemens.com/tia-selection-tool-standalone>.

PROFIBUS

ECOFASST Connection Block
(6ES7 194-3AA00-0AA0)
With Connector for adjusting PROFIBUS address
(6ES7 194-1KB00-0XA0)
or
M12 Connection Block
(6ES7 194-3AA00-0BA0)



ASM 456 (DP-V1)
Communication Module
(6GT2 002-0ED00)
RF160C (DP-V0)
Communication Module
(6GT2 002-0EF00)

A maximum of 2 Readers may be connected
ASM 456/ RF160C to RF620R/RF630R

2 m = 6GT2 891-4FH20 5 m = 6GT2 891-4FH50
10 m = 6GT2 891-4FN10 20 m = 6GT2 891-4FN20
50 m = 6GT2 891-4FN50
Reader connector 90° angled
2 m = 6GT2 891-4JH20 5 m = 6GT2 891-4JH50
10 m = 6GT2 891-4JN10

Ethernet TCP/IP



Computers and non Siemens PLCs

Ethernet TP cable through switch. See Page 60 for RF182C Cabling/ Connectors



RF182C
Communication Module
(6GT2 002-0JD10)

A maximum of 2 Readers may be connected
RF182C to RF620R/RF630R

Connection Blocks:
M12, 7/8" – 5 pole power (6GT2 002-1JD00)
Push Pull RJ45 (6GT2 002-2JD00)
M12, 7/8" – 4 pole power (6GT2 002-4JD00)

2 m = 6GT2 891-4FH20 5 m = 6GT2 891-4FH50
10 m = 6GT2 891-4FN10 20 m = 6GT2 891-4FN20
50 m = 6GT2 891-4FN50
Reader connector 90° angled
2 m = 6GT2 891-4JH20 5 m = 6GT2 891-4JH50
10 m = 6GT2 891-4JN10

Ethernet/IP

RFID 181EIP
Communication Module
(6GT2 002-0JD20)

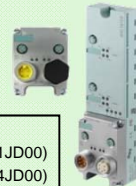

A maximum of 2 Readers may be connected
RFID 181EIP to RF620R/RF630R

Connection Blocks:
M12, 7/8" – 5 pole power (6GT2 002-1JD00)
M12, 7/8" – 4 pole power (6GT2 002-4JD00)

2 m = 6GT2 891-4FH20 5 m = 6GT2 891-4FH50
10 m = 6GT2 891-4FN10 20 m = 6GT2 891-4FN20
50 m = 6GT2 891-4FN50
Reader connector 90° angled
2 m = 6GT2 891-4JH20 5 m = 6GT2 891-4JH50
10 m = 6GT2 891-4JN10

RS232/RS422



MOBY API serial application on DVD

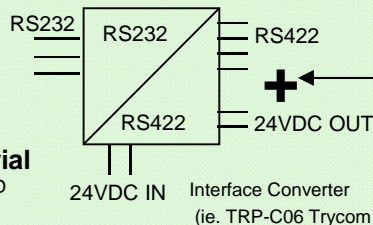

24VDC IN Interface Converter (ie. TRP-C06 Trycom IP)

1 Reader per COM port may be connected

Open Wire to RF620R/RF630R

2 m = 6GT2 891-4EH20
5 m = 6GT2 891-4EH50

Reader

powered through connection cable

RF620R
(Internal antenna used)
6GT2 811-5BA00-0AA0 (ETSI)
6GT2 811-5BA00-1AA0 (FCC)
6GT2 811-5BA00-2AA1 (CMIIT)



RF620R
(external antenna used)
6GT2 811-5BA00-0AA0 (ETSI)
6GT2 811-5BA00-1AA0 (FCC)
6GT2 811-5BA00-2AA1 (CMIIT)



RF630R
6GT2 811-4AA00-0AA1 (ETSI)
6GT2 811-4AA00-1AA1 (FCC)
6GT2 811-4AA00-2AA1 (CMIIT)

RF620A
6GT2812-1EA00, ETSI
6GT2812-1EA01, FCC, CMIIT

Antenna Cable

1m = 6GT2815-0BH10
3m = 6GT2 815-0BH30
5m, flex = 6GT2 815-2BH50
10m, 2dB = 6GT2 815-1BN10

RF640A
6GT2 812-0GA08

RF642A
6GT2 812-1GA08

RF660A
6GT2 812-0AA00, ETSI
6GT2 812-0AA01, FCC, CMIIT

Antenna Mounting kit
6GT2 890-0AA00

Antenna Cable

1m = 6GT2815-0BH10
3m = 6GT2 815-0BH30
5m, flex = 6GT2 815-2BH50
10m, 2dB = 6GT2 815-1BN10
10m, 4dB = 6GT2 815-0BN10
15m, flex = 6GT2 815-2BN15
20m = 6GT2 815-0BN20
40m = 6GT2 815-0BN40

Antenna attenuator

3 dB = 6GT2 890-0BB00
6 dB = 6GT2 890-0BB10
10 dB = 6GT2 890-0BB20

Labels



RF630L
6GT2 810-2AB00
6GT2 810-2AB01
6GT2 810-2AB03
6GT2810-2AB04



RF640L
6GT2 810-2AC00 (ETSI)
6GT2 810-2AC10 (FCC)



RF680L
6GT2 810-2AG80



RF690L
6GT2 810-2AG00 (ETSI)
6GT2 810-2AG10 (FCC)

Tags



RF610T
6GT2 810-2BB80
6GT2 810-2BB80-0AX1



RF620T
6GT2 810-2HC81



RF625T
6GT2 810-2EE00 (ETSI)
6GT2 810-2EE01 (FCC)



RF630T
6GT2 810-2EC00 (ETSI)
6GT2 810-2EC10 (FCC)



RF640T Gen2
6GT2 810-2DC00 (ETSI)
6GT2 810-2DC10 (FCC)

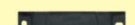

RF680T
6GT2 810-2HG80

Ethernet TCP/IP

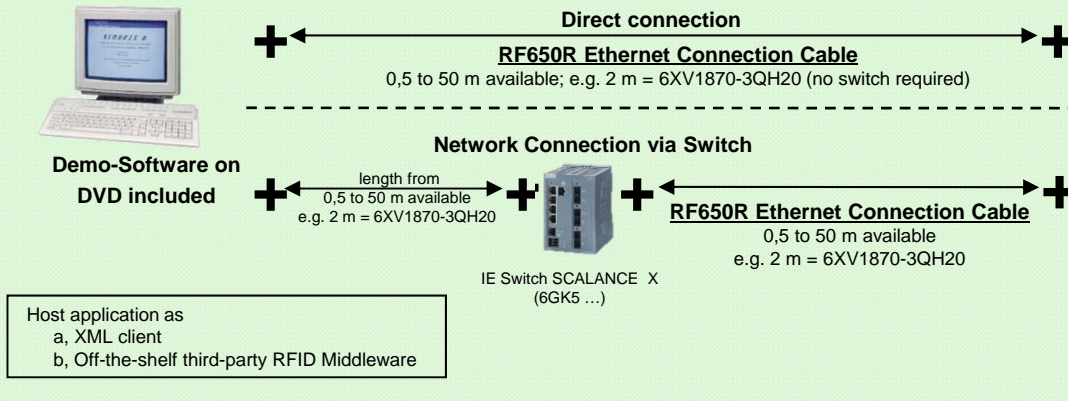

Ethernet TCP/IP & PROFINET

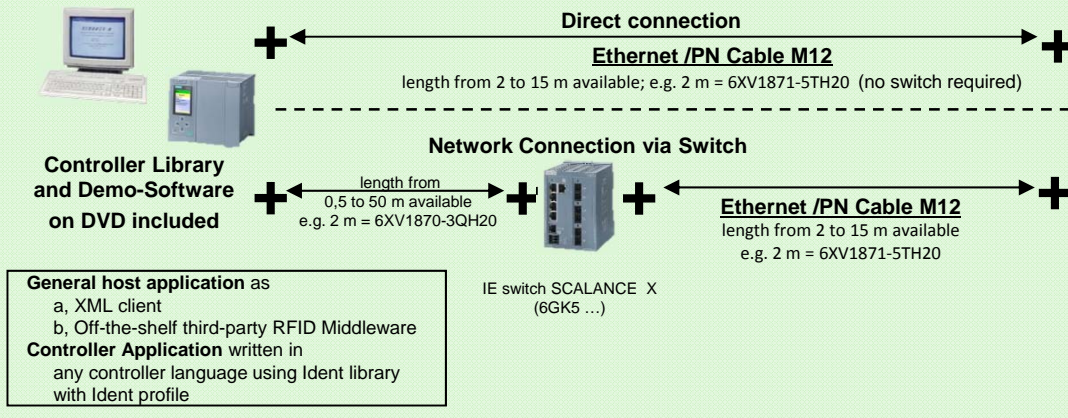

Reader

with external power supply



RF650R
(1 to 4 ext. antennas)

6GT2811-6AB20-0AA0 (ETSI)
 6GT2811-6AB20-1AA0 (FCC)
 6GT2811-6AB20-2AA0 (CMIIT)
 6GT2811-6AB20-4AA0 (ARIB)



RF680R
(1 to 4 ext. antennas)

6GT2811-6AA10-0AA0 (ETSI)
 6GT2811-6AA10-1AA0 (FCC)
 6GT2811-6AA10-2AA0 (CMIIT)
 6GT2811-6AA10-4AA0 (ARIB)



RF685R
(internal antenna and optional 1 ext. antenna)

6GT2811-6CA10-0AA0 (ETSI)
 6GT2811-6CA10-1AA0 (FCC)
 6GT2811-6CA10-2AA0 (CMIIT)
 6GT2811-6CA10-4AA0 (ARIB)

Cover caps
(6GT2898-4AA00)

- RF620A**
6GT2812-1EA00, ETSI
6GT2812-1EA01, FCC, etc.
- RF640A**
6GT2 812-0GA08
- RF642A**
6GT2 812-1GA08
- RF650A**
6GT2 812-0GB08
- RF660A**
6GT2 812-0AA00, ETSI
6GT2 812-0AA01, FCC, etc.
- RF680A**
6GT2 812-2GB08
- Antenna Mounting kit**
6GT2 890-0AA00

- Antenna Cable**
- 1m = 6GT2815-0BH10
- 3m = 6GT2 815-0BH30
- 5m, flex = 6GT2 815-2BH50
- 10m, 2dB = 6GT2 815-1BN10
- 10m, 4dB = 6GT2 815-0BN10
- 15m, flex = 6GT2 815-2BN15
- 20m = 6GT2 815-0BN20
- 40m = 6GT2 815-0BN40

Wide-Range power supply EU connector

6GT2 898-0AA00

UK connector

6GT2 898-0AA10

US connector

6GT2 898-0AA20

5 m cable for 24 V

6GT2 891-0PH50

optional

DI/DO cable 5m

6GT2891-0CH50

Rail mounting set

6GT2890-0AB00

Labels



RF622L
6GT2 810-4AC80



RF630L
6GT2 810-2AB00
6GT2 810-2AB01
6GT2 810-2AB03
6GT2810-2AB04
6GT2 810-2AE81-0AX1
6GT2810-2AC82
6GT2810-2AE80-0AX2



RF640L
6GT2 810-2AC00 (ETSI)
6GT2 810-2AC10 (FCC)

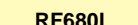

RF680L
6GT2 810-2AG80

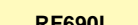

RF690L
6GT2 810-2AG00 (ETSI)
6GT2 810-2AG10 (FCC)

Tags



RF610T
6GT2 810-2BB80
6GT2 810-2BB80-0AX1

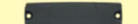

RF620T
6GT2 810-2HC81

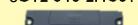

RF622T
6GT2 810-4HC80

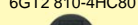

RF625T
6GT2 810-2EE00 (ETSI)
6GT2 810-2EE01 (FCC)



RF630T
6GT2 810-2EC00 (ETSI)
6GT2 810-2EC10 (FCC)

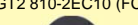

RF640T Gen2
6GT2 810-2DC00 (ETSI)
6GT2 810-2DC10 (FCC)

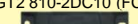

RF680T
6GT2 810-2HG80

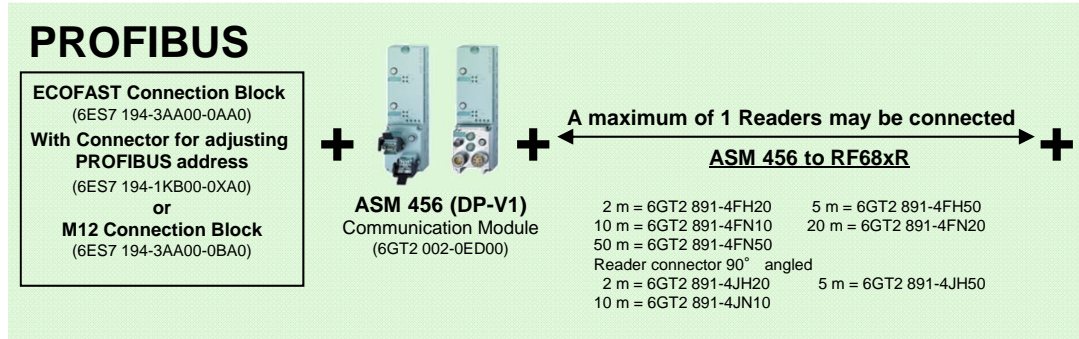

Reader

powered through connection cable

RF680R
(1 to 4 ext. antennas)
6GT2811-6AA10-0AA0 (ETSI)
6GT2811-6AA10-1AA0 (FCC)
6GT2811-6AA10-2AA0 (CMIIT)
6GT2811-6AA10-4AA0 (ARIB)

RF685R
(internal antenna and optional 1 ext. antenna)
6GT2811-6CA10-0AA0 (ETSI)
6GT2811-6CA10-1AA0 (FCC)
6GT2811-6CA10-2AA0 (CMIIT)
6GT2811-6CA10-4AA0 (ARIB)

Cover caps
(6GT2898-4AA00)

RF620A
6GT2812-1EA00, ETSI
6GT2812-1EA01, FCC, etc.

RF640A
6GT2 812-0GA08

RF642A
6GT2 812-1GA08

RF650A
6GT2 812-0GB08

RF660A
6GT2 812-0AA00, ETSI
6GT2 812-0AA01, FCC, etc.

RF680A
6GT2 812-2GB08

Antenna Mounting kit
6GT2 890-0AA00

Antenna Cable

1m	= 6GT2815-0BH10
3m	= 6GT2 815-0BH30
5m, flex	= 6GT2 815-2BH50
10m, 2dB	= 6GT2 815-1BN10
10m, 4dB	= 6GT2 815-0BN10
15m, flex	= 6GT2 815-2BN15
20m	= 6GT2 815-0BN20
40m	= 6GT2 815-0BN40

Labels

RF622L
6GT2 810-4AC80

RF630L
6GT2 810-2AB00
6GT2 810-2AB01
6GT2 810-2AB03
6GT2810-2AB04
6GT2 810-2AE81-0AX1
6GT2810-2AC82
6GT2810-2AE80-0AX2

RF640L
6GT2 810-2AC00 (ETSI)
6GT2 810-2AC10 (FCC)

RF680L
6GT2 810-2AG80

RF690L
6GT2 810-2AG00 (ETSI)
6GT2 810-2AG10 (FCC)

Tags

RF610T
6GT2 810-2BB80
6GT2 810-2BB80-0AX1

RF620T
6GT2 810-2HC81

RF622T
6GT2 810-4HC80

RF625T
6GT2 810-2EE00 (ETSI)
6GT2 810-2EE01 (FCC)





RF630T
6GT2 810-2EC00 (ETSI)
6GT2 810-2EC10 (FCC)

RF640T Gen2
6GT2 810-2DC00 (ETSI)
6GT2 810-2DC10 (FCC)



RF680T
6GT2 810-2HG80

optional
Rail mounting set
6GT2890-0AB00

RF350M

Packaged Systems		Additional Components		Spare Parts																													
Packaged Systems include Handheld unit, RFID read/ write head, and battery																																	
 <p>RF350M internal antenna</p>	<p>6GT2 803-1BA00 suitable for RF200, RF300 and MOBY D tags, except for D117, D127, D421, D422 and D5xx</p>	<p>Docking/ Charging Unit</p> 	<p>6GT2803-0BM00</p>	<p>Spare Battery 6GT2803-0CA00</p>																													
					Packaged Systems include Handheld unit, RFID read/ write head, and battery (Antenna and cable for usage is not included)																												
 <p>RF350M external antenna</p>	<p>6GT2 803-1BA10 Needs external antenna with antenna cable for usage</p> <p>suitable for RF200, RF300 and MOBY D tags according table in right column</p>	<p style="text-align: center;">External Antenna</p> <table border="1"> <thead> <tr> <th>Antenna type without cable</th> <th>MLFB</th> <th>Suitable for</th> </tr> </thead> <tbody> <tr> <td>Ant 3</td> <td>6GT2398-1CD30-0AX0</td> <td>D422, D423, D124, D324, D424, D425, D428, D160, D460 RF320T, RF330T, RF340T, RF350T</td> </tr> <tr> <td>Ant 3S</td> <td>6GT2398-1CD50-0AX0</td> <td>D117, D421, D422, D324, D425, D127, D428, D160, D460</td> </tr> <tr> <td>Ant 8</td> <td>6GT2 398-1CF00</td> <td>D117, D421, D127</td> </tr> <tr> <td>Antenna Cables 0,1 m 3 m</td> <td>6GT2 898-0EA00 6GT2 391-0AH30</td> <td>Ant 3(S), Ant 8</td> </tr> <tr> <th>Antenna type with cable (3 m)</th> <th>MLFB</th> <th>Suitable for</th> </tr> <tr> <td>Ant 12</td> <td>6GT2 398-1CC00</td> <td>D117, D421, D422, D324, D425, D127, D428, D160, D460</td> </tr> <tr> <td>Ant 18</td> <td>6GT2 398-1CA00</td> <td>D421, D422, D423, D124, D324, D424, D425, D428, D160, D460, RF320T, RF330T, RF340T</td> </tr> <tr> <td>Ant 30</td> <td>6GT2 398-1CD00</td> <td>D422, D423, D124, D324, D424, D425, D126, D426, D428, D160, D460, RF320T, RF330T, RF340T, RF350T</td> </tr> </tbody> </table>		Antenna type without cable	MLFB	Suitable for	Ant 3	6GT2398-1CD30-0AX0	D422, D423, D124, D324, D424, D425, D428, D160, D460 RF320T, RF330T, RF340T, RF350T	Ant 3S	6GT2398-1CD50-0AX0	D117, D421, D422, D324, D425, D127, D428, D160, D460	Ant 8	6GT2 398-1CF00	D117, D421, D127	Antenna Cables 0,1 m 3 m	6GT2 898-0EA00 6GT2 391-0AH30	Ant 3(S), Ant 8	Antenna type with cable (3 m)	MLFB	Suitable for	Ant 12	6GT2 398-1CC00	D117, D421, D422, D324, D425, D127, D428, D160, D460	Ant 18	6GT2 398-1CA00	D421, D422, D423, D124, D324, D424, D425, D428, D160, D460, RF320T, RF330T, RF340T	Ant 30	6GT2 398-1CD00	D422, D423, D124, D324, D424, D425, D126, D426, D428, D160, D460, RF320T, RF330T, RF340T, RF350T	<p>Docking/ Charging Unit</p> 	<p>6GT2803-0BM00</p>	<p>Spare Battery 6GT2803-0CA00</p>
		Antenna type without cable	MLFB	Suitable for																													
Ant 3	6GT2398-1CD30-0AX0	D422, D423, D124, D324, D424, D425, D428, D160, D460 RF320T, RF330T, RF340T, RF350T																															
Ant 3S	6GT2398-1CD50-0AX0	D117, D421, D422, D324, D425, D127, D428, D160, D460																															
Ant 8	6GT2 398-1CF00	D117, D421, D127																															
Antenna Cables 0,1 m 3 m	6GT2 898-0EA00 6GT2 391-0AH30	Ant 3(S), Ant 8																															
Antenna type with cable (3 m)	MLFB	Suitable for																															
Ant 12	6GT2 398-1CC00	D117, D421, D422, D324, D425, D127, D428, D160, D460																															
Ant 18	6GT2 398-1CA00	D421, D422, D423, D124, D324, D424, D425, D428, D160, D460, RF320T, RF330T, RF340T																															
Ant 30	6GT2 398-1CD00	D422, D423, D124, D324, D424, D425, D126, D426, D428, D160, D460, RF320T, RF330T, RF340T, RF350T																															

RF600

Packaged Systems		Additional Components	Spare Parts
Packaged Systems include Handheld unit, RFID read/ write head, integrated WLAN and battery		Docking/ Charging Unit  6GT2 898-0BB00	
 RF650M	6GT2 813-0CA00 (ETSI)		Spare Battery 6GT2 898-0CB00
 RF650M	6GT2 813-0CA10 (FCC)		



SIMATIC Ident DVD
6GT2 080-2AA20

SIMATIC Ident Software DVD contains:

- Complete manual set in all available languages
- Includes all manuals for optical identification
- S7 FC/ FBs for STEP 7 and TIA-Portal
- MOBY D/ RF200/ RF300 PC Application
- Programming Libraries (APIs)
- Start up and Demo for RF182C via Ethernet
- Example applications with source code and description
- RFID PC demo program
- Tag temperature calculation software
- HSP files for S7
- PROFIBUS/ PROFINET GSD/GSDML files
- IO-Link IODD files
- Tool for data throughput calculation
- Documentation archive for cancelled products

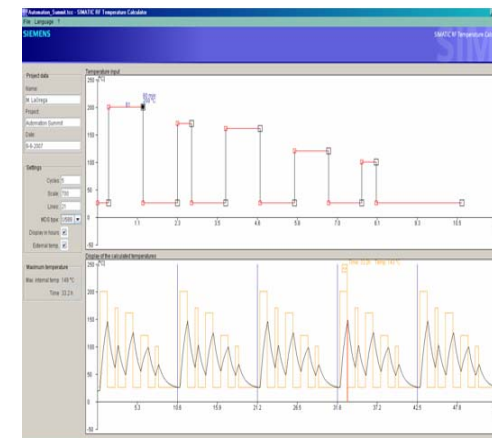
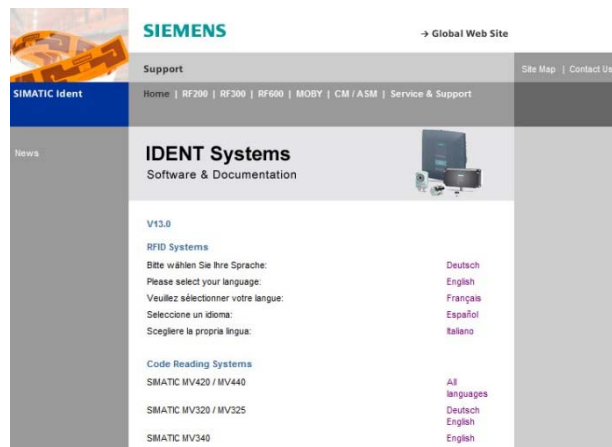

SIMATIC RF-DIAG

Wide-Range power supply
EU connector
 (6GT2 898-0AA00)
UK connector
 (6GT2 898-0AA10)
US connector
 (6GT2 898-0AA20)
Connection cable for Wide-Range power supply
 (6GT2 891-0PH50)

Direct connection from PC via RF-DIAG PC adapter to Reader

A maximum of 1 Readers may be connected

RF- DIAG PC adapter to RF620R/RF630R

2 m cable (6GT2891-4FH20) is delivered with SIMATIC RF-DIAG

Reader
 powered through connection cable



RF620R
 6GT2 811-5BA00-0AA0 (ETSI)
 6GT2 811-5BA00-1AA0 (FCC)
 6GT2 811-5BA00-2AA1 (CMIIT)



RF630R
 6GT2 811-4AA00-0AA1 (ETSI)
 6GT2 811-4AA00-1AA1 (FCC)
 6GT2 811-4AA00-2AA1 (CMIIT)

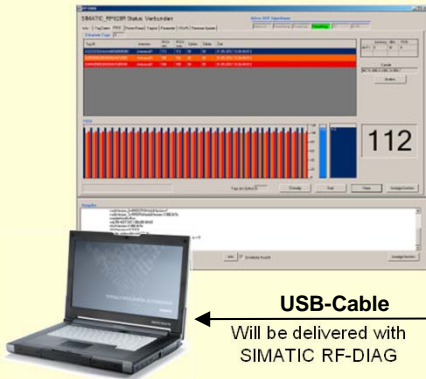

SIMATIC RF-DIAG
 (6GT2 080-3GA00)
 for Windows XP,
 Windows 7



RF-DIAG PC adapter
 is delivered with
 SIMATIC RF-DIAG
 (6GT2 080-3GA00)

Communication modules
 Connection to the
 RF-DIAG adapter with
 the existing reader cables



If the RF DIAG PC adapter is used in-between a Reader and a communicating module

A maximum of 1 Readers may be connected

RF- DIAG PC adapter to RF620R/RF630R

2 m cable (6GT2891-4FH20) is delivered with SIMATIC RF-DIAG

MV420: camera and lens selection

- Steps for selecting lens:**
1. Define the smallest dot size on DMC code or line width at barcode. Use the horizontal graph next to your size selection in the upper section
 2. Define the reading distance and draw a vertical line with a ruler (note: SR-B and SR-P have use the same diagrams)
 3. Select a lens and a camera type combination in the upper diagrams which fit best (green bars crossing)
 4. Verify at the lower diagrams that the field of view is within the range of your application

Note: For a more detailed selection or if your application is out the presented range ask the presales team at presales.ci.industry@siemens.com

Basic Models: **SR-B** (6GF3420-0AA20) (6GF3420-0AX20) or **SR-P** (6GF3420-0AA40) (6GF3420-0AX40)

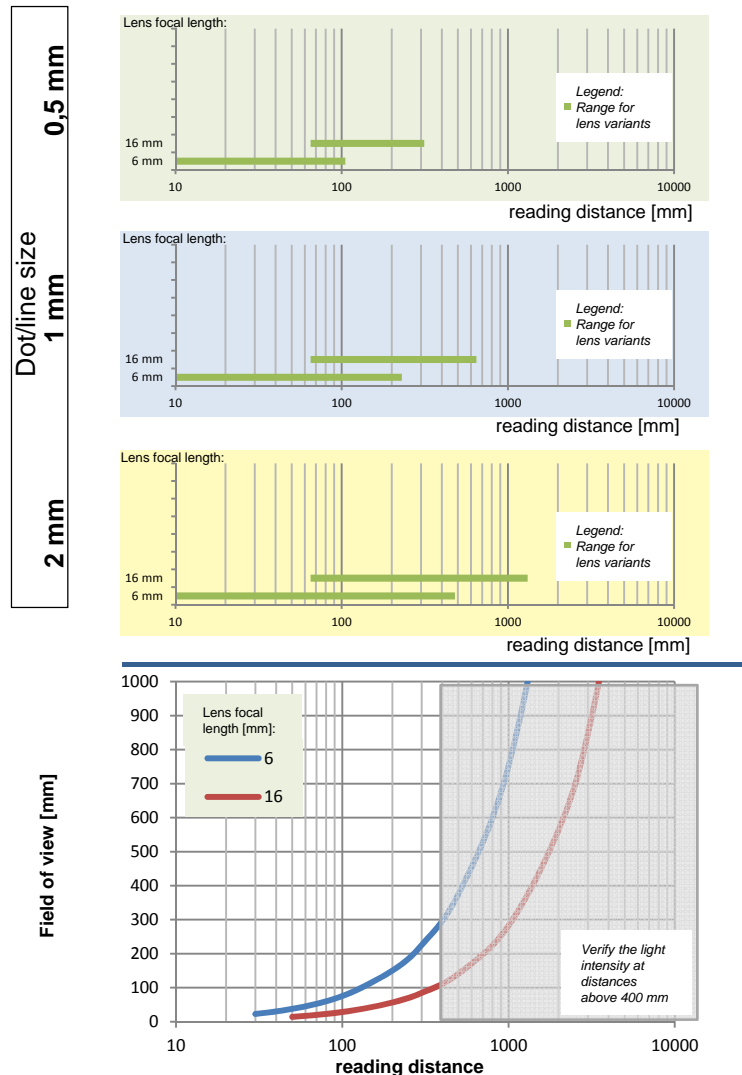

MV420 and MV440: light and filter selection

light and filter selection	Information for selection	MV420	MV440
Red light	The most popular light with a high light intensity	6GF3420-0AC00-1LTO	6GF3440-8DA11; 6GF3400-0LT01-8DA1 (external)
White light	Use white light if the color of the objects varies	6GF3420-0AC00-2LTO	6GF3440-8DA21
Green light	For usage with PCB and other green materials marked with dark codes		6GF3440-8DA31
Infrared light	No bothersome flashes	6GF3420-0AC00-3LTO	6GF3440-8DA41; 6GF3400-0LT01-7BA1 (external)
Blue filter	Only blue light passes. This may improve the structures of an object		6GF9001-2AE
Infrared filter	The usage together with infrared light filters completely the influence of daylight		6GF9001-2AD
Daylight filter	For protection of the camera against laser light beyond the visible spectrum		6GF3440-8EA1
Polarization filter	Use this filter to reduce reflections at metallic or shiny parts (i.e. plastic foils)		6GF9001-2AF

MV440: camera and lens selection

- Steps for selecting lens:**
1. Define the smallest dot size on DMC code or line width at barcode. Use the horizontal graphs next to your size selection in the upper section
 2. Define the reading distance and draw a vertical line with a ruler at every camera type (SR, HR, UR)
 3. Select a lens and a camera type combination in the upper diagrams which fit best (green bar crossing or red bar crossing (intermediate rings (IR) required))
 4. Verify at the lower diagrams that the field of view is within the range of your application

Note: For a more detailed selection or if your application is out the presented range ask the presales team at presales.ci.industry@siemens.com

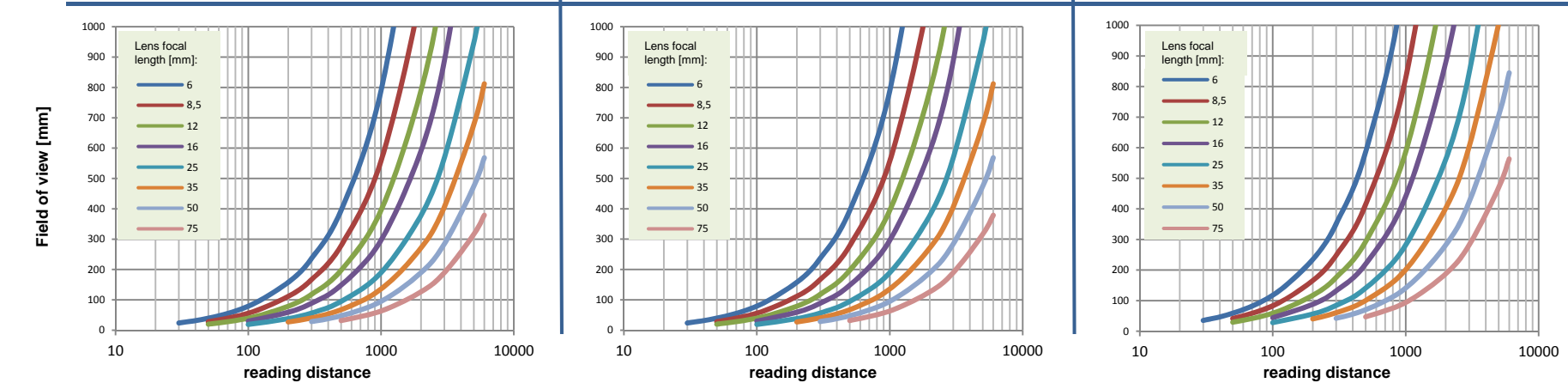
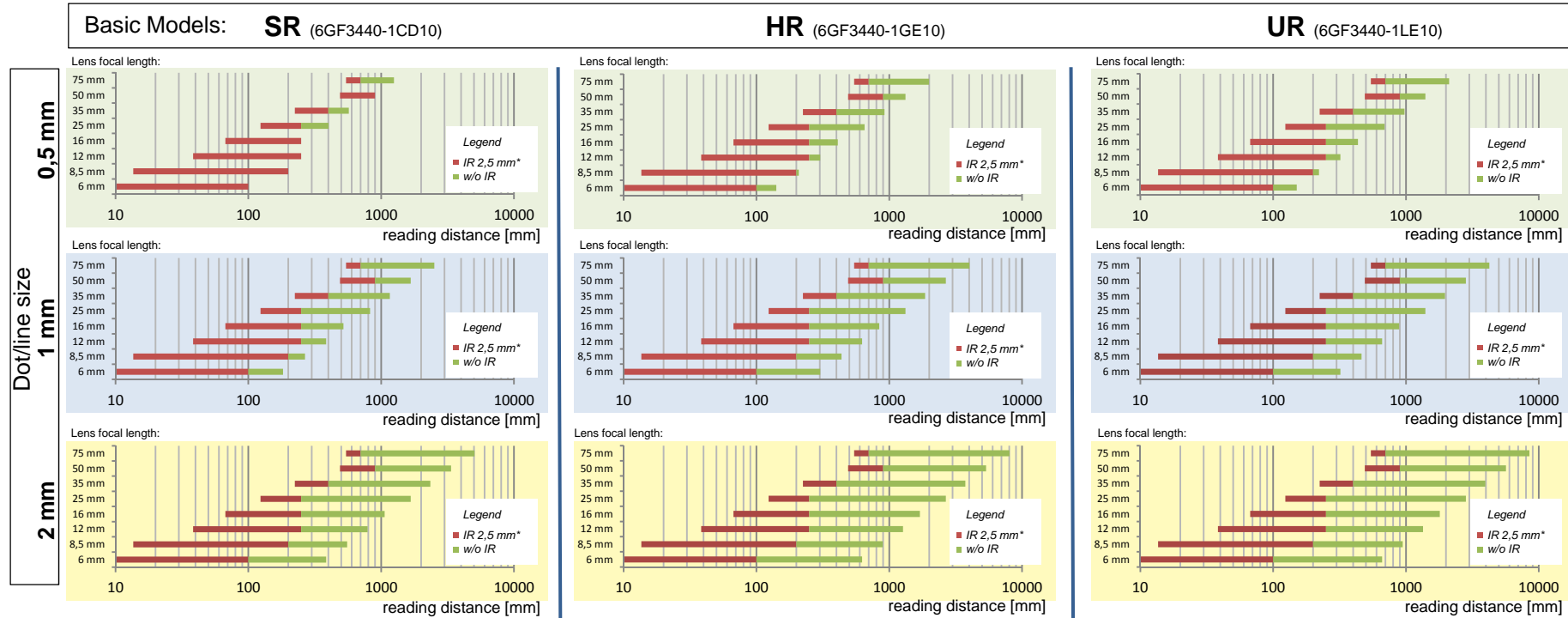

Ethernet TCP/IP

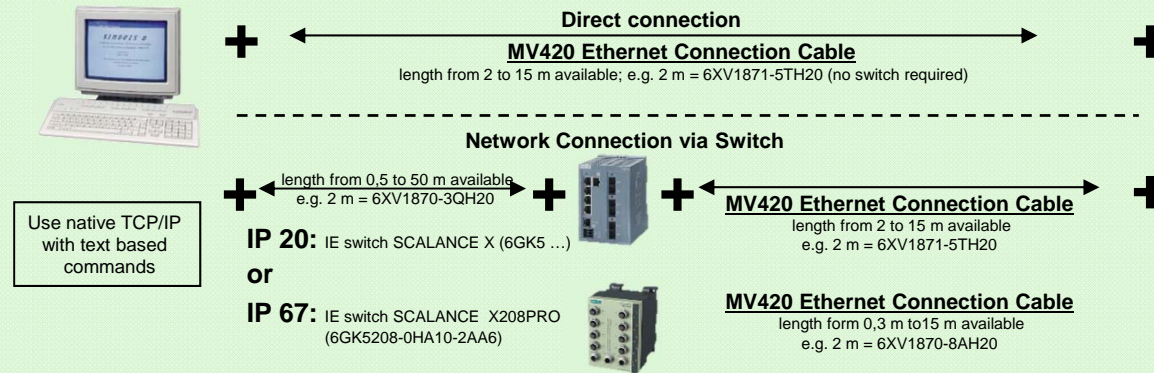

S7-1200 via Industrial Ethernet or PROFINET

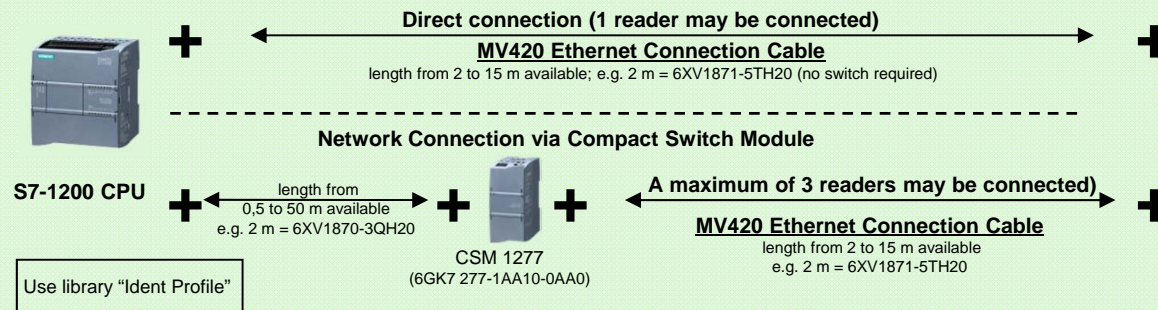

S7-300/1500 via Industrial Ethernet or PROFINET

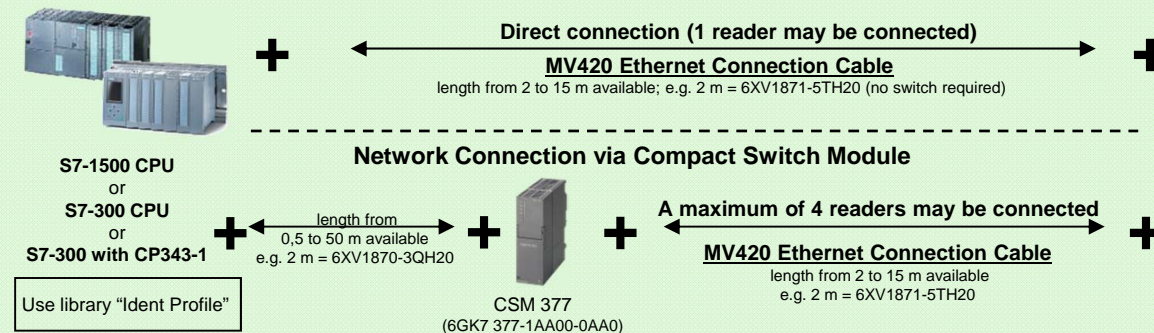

Reader

With external power supply



MV420 complete
 6 mm lens, red light
 (SR-B: 6GF3420-0AA20)
 (SR-P: 6GF3420-0AA40)



MV420 body
 (SR-B: 6GF3420-0AX20)
 (SR-P: 6GF3420-0AX40)



Lens
 6 mm
 (6GF3420-0AC00-0LK0)
 16 mm
 (6GF3420-0AC00-1LK0)



Lights
 red
 (6GF3420-0AC00-1LT0)
 white
 (6GF3420-0AC00-2LT0)
 infrared
 (6GF3420-0AC00-3LT0)

Options

DI/DO

Wires included in power supply cable
 Open wires

Support

Mounting bracket
 6GF3420-0AC00-1AA0

Cable for power supply

Open wires
 10 m = 6GF3440-8BA2
 30 m = 6GF3440-8BA4
or Push Pull
 1,5 m = 6GF3400-0BH15
 2 m = 6GF3400-1BH20

SIMATIC PLC

S7-1200



RF120C
6GT2 002-0LA00

A maximum of 1 reader may be connected
RF120C to MV420

2 m = 6GT2 091-4LH20
5 m = 6GT2 091-4LH50
10 m = 6GT2 091-4LN10
And extension cables:
2 m = 6GT2 891-4FH20
5 m = 6GT2 891-4FH50
10 m = 6GT2 891-4FN10
50 m = 6GT2 891-4FN50

adapting cable:
2 m = 6GF3420-0AC00-2CB0

SIMATIC PLC

S7-300 Rack or
S7-400 via ET 200M
(DP-V1/PN-IO)



ASM 475 + Front connector
(6GT2 002-0GA10) + (6ES7 392-1AJ00-0AA0)

Accessories:
Connecting element (6ES7 390-5AA00-0AA0)
Terminal element (6ES7 390-5BA00-0AA0)

A maximum of 2 readers may be connected
ASM 475 to MV420

2 m = 6GT2 891-4EH20
5 m = 6GT2 891-4EH50
And extension cables:
2 m = 6GT2 891-4FH20
5 m = 6GT2 891-4FH50
10 m = 6GT2 891-4FN10
20 m = 6GT2 891-4FN20
50 m = 6GT2 891-4FN50

adapting cable:
2 m = 6GF3420-0AC00-2CB0

ET 200pro
via PROFIBUS
or PROFINET
or S7 PLC

ET 200pro PROFIBUS DP-V1
Interface module

ET 200pro PROFINET
Interface module

ET 200pro PROFINET
CPU module

Up to 9 x 170C
modules per
ET 200pro rack

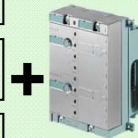

RF170C
Communication module
(6GT2002-0HD01)
Connection block
(6GT2002-1HD01)

A maximum of 2 readers may be connected
RF170C to MV420

Extension cables:
2 m = 6GT2 891-4FH20
5 m = 6GT2 891-4FH50
10 m = 6GT2 891-4FN10
20 m = 6GT2 891-4FN20
50 m = 6GT2 891-4FN50

adapting cable:
2 m = 6GF3420-0AC00-2CB

PROFINET

M12 Connection Block
(6GT2 002-1JD00)
or
Push Pull RJ45
(6GT2 002-2JD00)



RF180C
Communication Module
(6GT2 002-0JD00)

A maximum of 2 readers may be connected
RF180C to MV420

Extension cables:
2 m = 6GT2 891-4FH20
5 m = 6GT2 891-4FH50
10 m = 6GT2 891-4FN10
20 m = 6GT2 891-4FN20
50 m = 6GT2 891-4FN50

adapting cable:
2 m = 6GF3420-0AC00-2CB0

Reader

powered through connection cable



MV420 complete
6 mm lens, red light
(SR-B: 6GF3420-0AA20)
(SR-P: 6GF3420-0AA40)

Options

DI/DO

Use cable „Power supply DIO RS232“ + distribution frame instead of adapting cable

10 m = 6GF3440-8BA2
30 m = 6GF3440-8BA4

Web Interface

Use additional IE cable

Various lengths available
2 m = 6XV1871-5TH20

Support

Mounting bracket
6GF3420-0AC00-1AA0



MV420 body
(SR-B: 6GF3420-0AX20)
(SR-P: 6GF3420-0AX40)



Lens

6 mm
(6GF3420-0AC00-0LK0)
16 mm
(6GF3420-0AC00-1LK0)



Lights

red
(6GF3420-0AC00-1LT0)
white
(6GF3420-0AC00-2LT0)
infrared
(6GF3420-0AC00-3LT0)

PROFIBUS

ECOFAST Connection Block
(6ES7 194-3AA00-0AA0)
With Connector for adjusting PROFIBUS address
(6ES7 194-1KB00-0XA0)
or
M12 Connection Block
(6ES7 194-3AA00-0BA0)

ASM 456 (DP-V1)
Communication Module
(6GT2 002-0ED00)
RF160C (DP-V0)
Communication Module
(6GT2 002-0EF00)

A maximum of 2 readers may be connected
ASM 456/ RF160C to MV420

Extension cables: + adapting cable:
2 m = 6GT2 891-4FH20 2 m = 6GF3420-0AC00-2CB0
5 m = 6GT2 891-4FH50
10 m = 6GT2 891-4FN10
20 m = 6GT2 891-4FN20
50 m = 6GT2 891-4FN50

Ethernet TCP/IP



Computers and non Siemens PLCs

Ethernet TP cable through switch. See Page 60 for RF182C Cabling/ Connectors

RF182C
Communication Module
(6GT2 002-0JD10)

A maximum of 2 readers may be connected
RF182C to MV420

Extension cables: + adapting cable:
2 m = 6GT2 891-4FH20 2 m = 6GF3420-0AC00-2CB0
5 m = 6GT2 891-4FH50
10 m = 6GT2 891-4FN10
20 m = 6GT2 891-4FN20
50 m = 6GT2 891-4FN50

Connection Blocks:
M12, 7/8" – 5 pole power (6GT2 002-1JD00)
Push Pull RJ45 (6GT2 002-2JD00)
M12, 7/8" – 4 pole power (6GT2 002-4JD00)

Ethernet/IP

RFID 181EIP
Communication Module
(6GT2 002-0JD20)



A maximum of 2 readers may be connected
RFID 1801EIP to MV420

Extension cables: + adapting cable:
2 m = 6GT2 891-4FH20 2 m = 6GF3420-0AC00-2CB0
5 m = 6GT2 891-4FH50
10 m = 6GT2 891-4FN10
20 m = 6GT2 891-4FN20
50 m = 6GT2 891-4FN50

Connection Blocks:
M12, 7/8" – 5 pole power (6GT2 002-1JD00)
M12, 7/8" – 4 pole power (6GT2 002-4JD00)

Reader

powered through connection cable



MV420 complete
6 mm lens, red light
(SR-B: 6GF3420-0AA20)
(SR-P: 6GF3420-0AA40)

Options

DI/DO

Use cable „Power supply DIO RS232“ + distribution frame instead of adapting cable

10 m = 6GF3440-8BA2
30 m = 6GF3440-8BA4

Web Interface

Use additional IE cable

Various lengths available
2 m = 6XV1871-5TH20

Support

Mounting bracket
6GF3420-0AC00-1AA0



Lens

6 mm (6GF3420-0AC00-0LK0)
16 mm (6GF3420-0AC00-1LK0)



Lights

red (6GF3420-0AC00-1LT0)
white (6GF3420-0AC00-2LT0)
infrared (6GF3420-0AC00-3LT0)



MV420 body
(SR-B: 6GF3420-0AX20)
(SR-P: 6GF3420-0AX40)

Serial RS232



Simple text based protocol

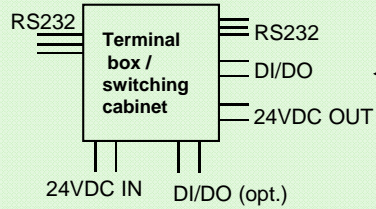

1 Reader per COM port may be connected
RS 232 cable for MV420 (open wires) +
 10 m = 6GF3440-8BA2
 30 m = 6GF3440-8BA4

Reader

With external power supply



MV420 complete
 6 mm lens, red light
 (SR-B: 6GF3420-0AA20)
 (SR-P: 6GF3420-0AA40)



MV420 body
 (SR-B: 6GF3420-0AX20)
 (SR-P: 6GF3420-0AX40)



Lens
 6 mm
 (6GF3420-0AC00-0LK0)
 16 mm
 (6GF3420-0AC00-1LK0)



Lights
 red
 (6GF3420-0AC00-1LT0)
 white
 (6GF3420-0AC00-2LT0)
 infrared
 (6GF3420-0AC00-3LT0)

Options

DI/DO

Wires included in RS232 / power supply cable
 Open wires

Web Interface

Use additional IE cable
 Various lengths available
 2 m = 6XV1871-5TH20

Support

Mounting bracket
 6GF3420-0AC00-1AA0

Ethernet TCP/IP

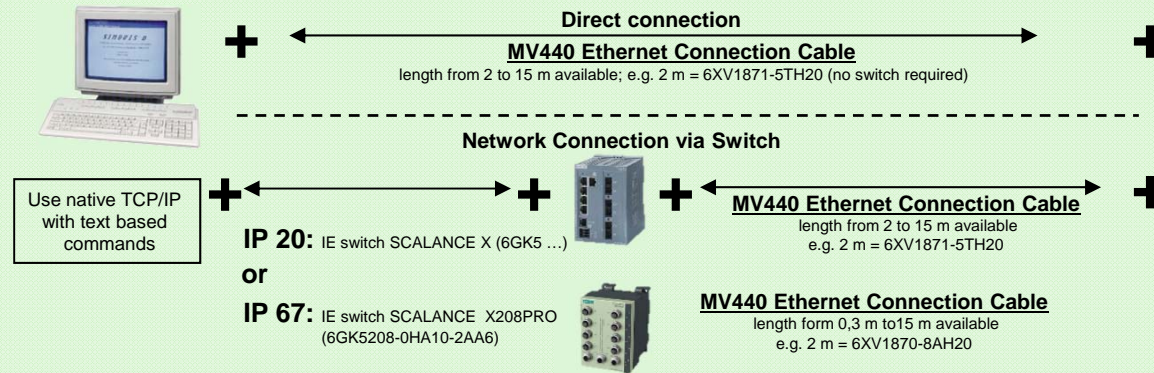

S7-1200 via Industrial Ethernet or PROFINET

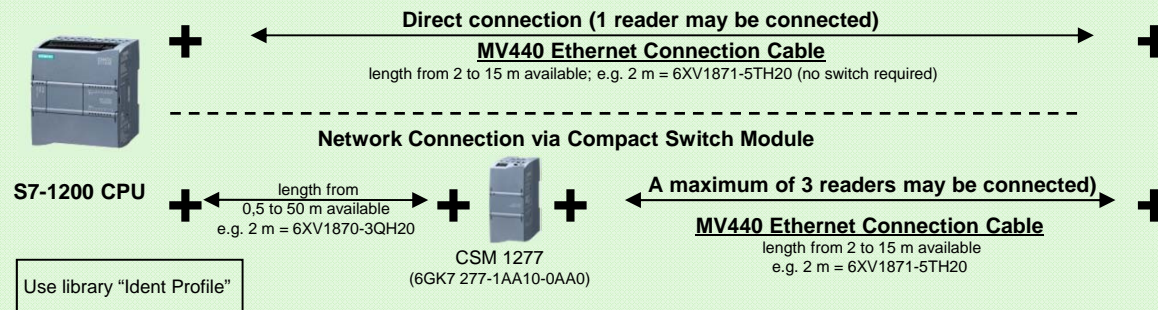

S7-300/1500 via Industrial Ethernet or PROFINET

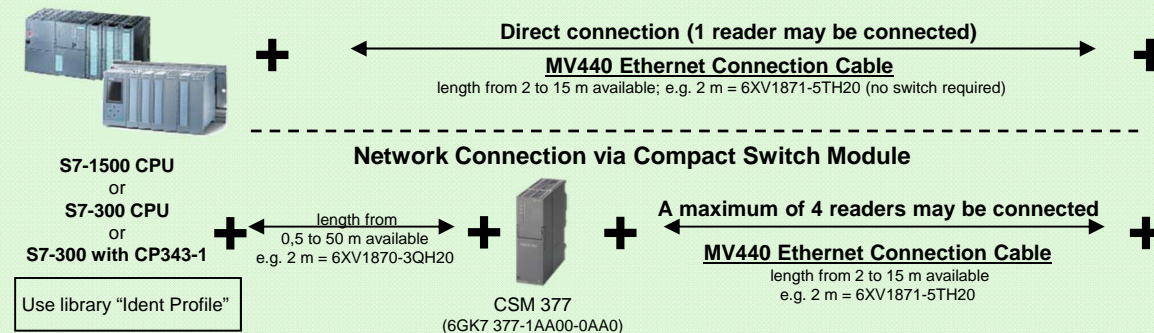

Reader

With external power supply



MV440

SR; 640 x 480 pixel:
 (6GF3440-1CD10)
 HR; 1024 x 768 pixel:
 (6GF3440-1GE10)
 UR; 1600 x 1200 pixel:
 (6GF3440-1LE10)



Lens

6 mm (6GF9001-1BB01)
 8,5 mm ** (6GF9001-1BE01)
 12 mm (6GF9001-1BL01)
 16 mm (6GF9001-1BF01)
 25 mm (6GF9001-1BG01)
 35 mm (6GF9001-1BH01)
 50 mm (6GF9001-1BJ01)
 75 mm ** *** (6GF9001-1BK01)



Lights build-in

red (6GF3440-8DA11)
 white (6GF3440-8DA21)
 green (6GF3440-8DA31)
 infrared (6GF3440-8DA41)



Lights external *)

red (6GF3400-0LT01-8DA1)
 infrared (6GF3400-0LT01-7BA1)

Cable for power supply

Open wires

10 m = 6GF3440-8BA2
 30 m = 6GF3440-8BA4

or Push Pull

1,5 m = 6GF3400-0BH15
 2 m = 6GF3400-1BH20

Or Wide-Range power supply

EU connector

6GT2 898-0AA00

UK connector

6GT2 898-0AA10

US connector

6GT2 898-0AA20

5 m cable for 24 V

6GT2 891-0PH50

+

Cable adapter M16/M12 (6GF3440-8BD1)

+

Or Cable M12/open wire (6GF3440-8BC4)

+

Mounting plate (6GF3440-8CD01)

Options

DI/DO *)

Wires included in power supply cable „Open wires“

Software

Text-Genius
 6GF3400-0SL01
 Text-Genius Plus
 6GF3400-1SL01
 Veri-Genius
 6GF3400-0SL02
 Pat-Genius
 6GF3400-0SL03

Support

Mounting plate
 6GF3440-8CA
 Tri-plate
 6GF9002-7AD

Opt. for Lens rings

0,5, 1, 5, 10, 20, 40 mm
 6GF9001-1BU
 0,5, 1 mm
 6GF9001-1BU01
 length doubler
 6GF9001-1BV

Filter

infrared
 6GF9001-2AD
 blue
 6GF9001-2AE
 polarization
 6GF9001-2AF
 daylight
 6GF3440-8EA1

Protective lens cover

metal glas
 6GF3440-8AC11
 metal plastic
 6GF3440-8AC21
 plastic (included in basic model)
 6GF3440-8AC12

*) Additional power supply needed
 **) not in combination with build-in lights;
 ***) for protection order additional the tube extension 6GF3440-8AC13

Ethernet TCP/IP or PROFINET (PoE)

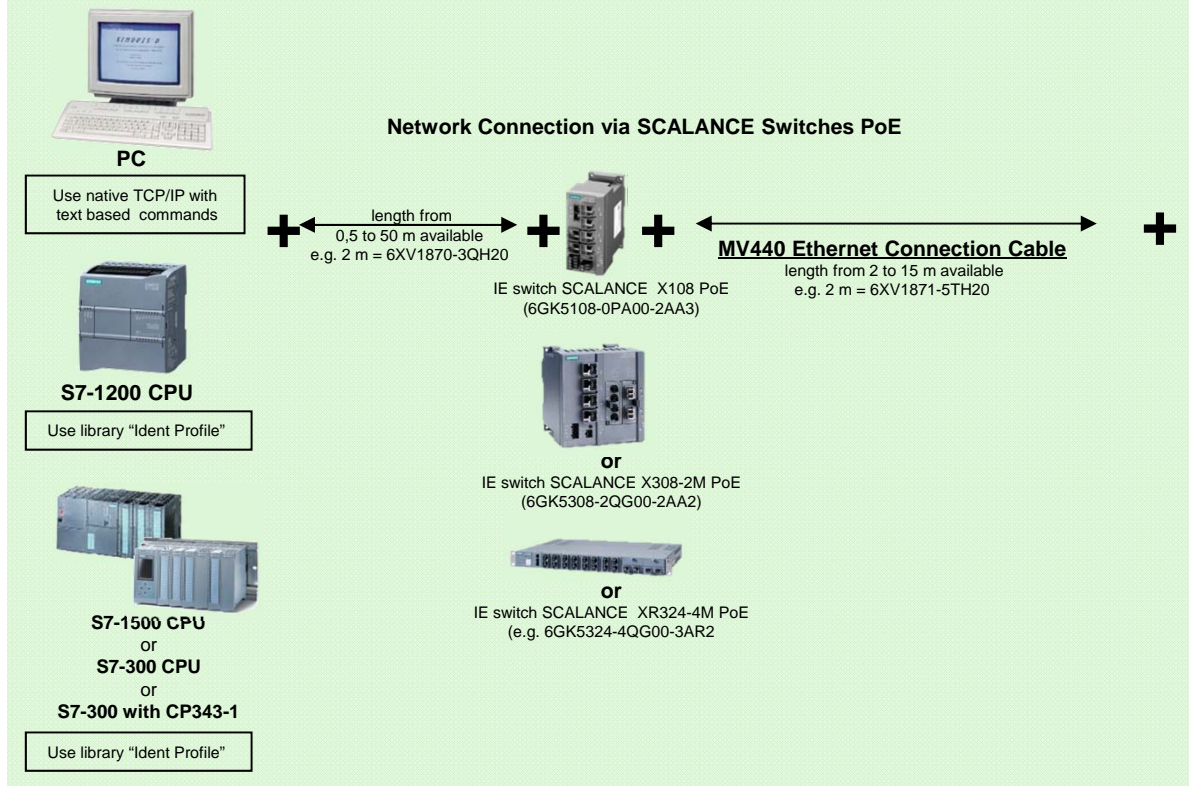

Reader

With power supply over Ethernet (PoE)

-
- Lens**
- 6 mm (6GF9001-1BB01)
 - 8,5 mm (**)
 - 12 mm (6GF9001-1BE01)
 - 16 mm (6GF9001-1BL01)
 - 25 mm (6GF9001-1BF01)
 - 35 mm (6GF9001-1BG01)
 - 50 mm (6GF9001-1BH01)
 - 75 mm (***)
 - 75 mm (***)
 - 75 mm (***)
 - 75 mm (***)



MV440

SR; 640 x 480 pixel:
(6GF3440-1CD10)
HR; 1024 x 768 pixel:
(6GF3440-1GE10)
UR; 1600 x 1200 pixel:
(6GF3440-1LE10)

-
- Lights build-in**
- red (6GF3440-8DA11)
 - white (6GF3440-8DA21)
 - green (6GF3440-8DA31)
 - infrared (6GF3440-8DA41)

-
- Lights external *)**
- red (6GF3400-0LT01-8DA1)
 - infrared (6GF3400-0LT01-7BA1)

+

Cable adapter M16/M12
(6GF3440-8BD1)

Or
Cable M12/open wire
(6GF3440-8BC4)

+

Mounting plate
(6GF3440-8CD01)

*) Additional power supply needed
**) not in combination with build-in lights;
***) for protection order additional the tube extension 6GF3440-8AC13

Options

DI/DO *)

„Power supply DIO RS232“
10 m = 6GF3440-8BA2
30 m = 6GF3440-8BA4

Software

Text-Genius
6GF3400-0SL01
Text-Genius Plus
6GF3400-1SL01
Veri-Genius
6GF3400-0SL02
Pat-Genius
6GF3400-0SL03

Support

Mounting plate
6GF3440-8CA
Tri-plate
6GF9002-7AD

Opt. for Lens rings

0,5, 1, 5, 10, 20, 40 mm
6GF9001-1BU
0,5, 1 mm
6GF9001-1BU01
length doubler
6GF9001-1BV

Filter

infrared
6GF9001-2AD
blue
6GF9001-2AE
polarization
6GF9001-2AF
daylight
6GF3440-8EA1

Protective lens cover

metal glas
6GF3440-8AC11
metal plastic
6GF3440-8AC21
plastic (included in basic model)
6GF3440-8AC12

SIMATIC PLC S7-1200



RF120C
6GT2 002-0LA00

A maximum of 1 reader may be connected
RF120C to MV440

- | | |
|-----------------------------|-----------------------|
| 2 m = 6GT2 091-4LH20 | 5 m = 6GT2 091-4LH50 |
| 10 m = 6GT2 091-4LN10 | |
| And extension cables: | |
| 2 m = 6GT2 891-4FH20 | 5 m = 6GT2 891-4FH50 |
| 10 m = 6GT2 891-4FN10 | 20 m = 6GT2 891-4FN20 |
| 50 m = 6GT2 891-4FN50 | |
| Reader connector 90° angled | |
| 2 m = 6GT2 891-4JH20 | 5 m = 6GT2 891-4JH50 |
| 10 m = 6GT2 891-4JN10 | |

SIMATIC PLC S7-300 Rack or S7-400 via ET 200M (DP-V1/PN-IO)



ASM 475 + Front connector
(6GT2 002-0GA10) + (6ES7 392-1AJ00-0AA0)

Accessories:
Connecting element (6ES7 390-5AA00-0AA0)
Terminal element (6ES7 390-5BA00-0AA0)



A maximum of 2 readers may be connected
ASM 475 to MV440

- | | |
|-----------------------------|-----------------------|
| 2 m = 6GT2 891-4EH20 | 5 m = 6GT2 891-4EH50 |
| And extension cables: | |
| 2 m = 6GT2 891-4FH20 | 5 m = 6GT2 891-4FH50 |
| 10 m = 6GT2 891-4FN10 | 20 m = 6GT2 891-4FN20 |
| 50 m = 6GT2 891-4FN50 | |
| Reader connector 90° angled | |
| 2 m = 6GT2 891-4JH20 | 5 m = 6GT2 891-4JH50 |
| 10 m = 6GT2 891-4JN10 | |

ET 200pro via PROFIBUS or PROFINET or S7 PLC

ET 200pro PROFIBUS DP-V1
Interface module

ET 200pro PROFINET
Interface module

ET 200pro PROFINET
CPU module

Up to 9 x 170C
modules per
ET 200pro rack

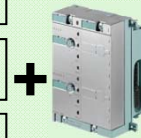

RF170C
Communication module
(6GT2002-0HD01)
Connection block
(6GT2002-1HD01)

A maximum of 2 readers may be connected
RF170C to MV440

- | | |
|-----------------------------|-----------------------|
| 2 m = 6GT2 891-4FH20 | 5 m = 6GT2 891-4FH50 |
| 10 m = 6GT2 891-4FN10 | 20 m = 6GT2 891-4FN20 |
| 50 m = 6GT2 891-4FN50 | |
| Reader connector 90° angled | |
| 2 m = 6GT2 891-4JH20 | 5 m = 6GT2 891-4JH50 |
| 10 m = 6GT2 891-4JN10 | |

PROFINET

M12 Connection Block
(6GT2 002-1JD00)
or
Push Pull RJ45
(6GT2 002-2JD00)



RF180C
Communication Module
(6GT2 002-0JD00)

A maximum of 2 readers may be connected
RF180C to MV440

- | | |
|-----------------------------|-----------------------|
| 2 m = 6GT2 891-4FH20 | 5 m = 6GT2 891-4FH50 |
| 10 m = 6GT2 891-4FN10 | 20 m = 6GT2 891-4FN20 |
| 50 m = 6GT2 891-4FN50 | |
| Reader connector 90° angled | |
| 2 m = 6GT2 891-4JH20 | 5 m = 6GT2 891-4JH50 |
| 10 m = 6GT2 891-4JN10 | |

Reader powered through connection cable



- Lens**
- 6 mm (6GF9001-1BB01)
 - 8,5 mm ** (6GF9001-1BE01)
 - 12 mm (6GF9001-1BL01)
 - 16 mm (6GF9001-1BF01)
 - 25 mm (6GF9001-1BG01)
 - 35 mm (6GF9001-1BH01)
 - 50 mm (6GF9001-1BJ01)
 - 75 mm ** *** (6GF9001-1BK01)



MV440

- SR; 640 x 480 pixel: (6GF3440-1CD10)
- HR; 1024 x 768 pixel: (6GF3440-1GE10)
- UR; 1600 x 1200 pixel: (6GF3440-1LE10)



- Lights build-in**
- red (6GF3440-8DA11)
 - white (6GF3440-8DA21)
 - green (6GF3440-8DA31)
 - infrared (6GF3440-8DA41)



- Lights external *)**
- red (6GF3400-0LT01-8DA1)
 - infrared (6GF3400-0LT01-7BA1)

+

Cable adapter M16/M12 (6GF3440-8BD1)

Or

Cable M12/open wire (6GF3440-8BC4)

+

Mounting plate (6GF3440-8CD01)

*) Additional power supply needed
**) not in combination with build-in lights;
***) for protection order additional the tube extension 6GF3440-8AC13

Options

D/DO *)

- „Power supply DIO RS232“
- 10 m = 6GF3440-8BA2
 - 30 m = 6GF3440-8BA4

Software

- Text-Genius 6GF3400-0SL01
- Text-Genius Plus 6GF3400-1SL01
- Veri-Genius 6GF3400-0SL02
- Pat-Genius 6GF3400-0SL03

Web Interface

- Use additional IE cable
- Various lengths available
- 2 m = 6XV1871-5TH20

Support

- Mounting plate 6GF3440-8CA
- Tri-plate 6GF9002-7AD

Opt. for Lens rings

- 0.5, 1, 5, 10, 20, 40 mm 6GF9001-1BU
- 0.5, 1 mm 6GF9001-1BU01
- length doubler 6GF9001-1BV

Filter

- infrared 6GF9001-2AD
- blue 6GF9001-2AE
- polarization 6GF9001-2AF
- daylight 6GF3440-8EA1

Protective lens cover

- metal glas 6GF3440-8AC11
- metal plastic 6GF3440-8AC21
- plastic (included in basic model) 6GF3440-8AC12

PROFIBUS

ECOFAST Connection Block
(6ES7 194-3AA00-0AA0)
With Connector for adjusting PROFIBUS address
(6ES7 194-1KB00-0XA0)
or
M12 Connection Block
(6ES7 194-3AA00-0BA0)



A maximum of 2 readers may be connected
ASM 456/ RF160C to MV440

- | | |
|-----------------------|-----------------------|
| 2 m = 6GT2 891-4FH20 | 5 m = 6GT2 891-4FH50 |
| 10 m = 6GT2 891-4FN10 | 20 m = 6GT2 891-4FN20 |
| 50 m = 6GT2 891-4FN50 | |
- Reader connector 90° angled
2 m = 6GT2 891-4JH20 5 m = 6GT2 891-4JH50
10 m = 6GT2 891-4JN10

Ethernet TCP/IP



Ethernet TP cable through switch. See Page 60 for RF182C Cabling/ Connectors



RF182C
Communication Module
(6GT2 002-0JD10)

Computers and non Siemens PLCs

Connection Blocks:
M12, 7/8" – 5 pole power (6GT2 002-1JD00)
Push Pull RJ45 (6GT2 002-2JD00)
M12, 7/8" – 4 pole power (6GT2 002-4JD00)

A maximum of 2 readers may be connected
RF182C to MV440

- | | |
|-----------------------|-----------------------|
| 2 m = 6GT2 891-4FH20 | 5 m = 6GT2 891-4FH50 |
| 10 m = 6GT2 891-4FN10 | 20 m = 6GT2 891-4FN20 |
| 50 m = 6GT2 891-4FN50 | |
- Reader connector 90° angled
2 m = 6GT2 891-4JH20 5 m = 6GT2 891-4JH50
10 m = 6GT2 891-4JN10

Ethernet/IP

RFID 181EIP
Communication Module
(6GT2 002-0JD20)



Connection Blocks:
M12, 7/8" – 5 pole power (6GT2 002-1JD00)
M12, 7/8" – 4 pole power (6GT2 002-4JD00)

A maximum of 2 readers may be connected
RFID 181EIP to MV440

- | | |
|-----------------------|-----------------------|
| 2 m = 6GT2 891-4FH20 | 5 m = 6GT2 891-4FH50 |
| 10 m = 6GT2 891-4FN10 | 20 m = 6GT2 891-4FN20 |
| 50 m = 6GT2 891-4FN50 | |
- Reader connector 90° angled
2 m = 6GT2 891-4JH20 5 m = 6GT2 891-4JH50
10 m = 6GT2 891-4JN10

Reader

powered through connection cable



- Lens**
6 mm (6GF9001-1BB01)
8,5 mm **) (6GF9001-1BE01)
12 mm (6GF9001-1BL01)
16 mm (6GF9001-1BF01)
25 mm (6GF9001-1BG01)
35 mm (6GF9001-1BH01)
50 mm (6GF9001-1BJ01)
75 mm **) (***) (6GF9001-1BK01)



MV440

- SR; 640 x 480 pixel: (6GF3440-1CD10)
HR; 1024 x 768 pixel: (6GF3440-1GE10)
UR; 1600 x 1200 pixel: (6GF3440-1LE10)



- Lights build-in**
red (6GF3440-8DA11)
white (6GF3440-8DA21)
green (6GF3440-8DA31)
infrared (6GF3440-8DA41)



- Lights external *)**
red (6GF3400-0LT01-8DA1)
infrared (6GF3400-0LT01-7BA1)

+

Cable adapter M16/M12 (6GF3440-8BD1)
Or
Cable M12/open wire (6GF3440-8BC4)

+

Mounting plate (6GF3440-8CD01)

*) Additional power supply needed
**) not in combination with build-in lights;
***) for protection order additional the tube extension 6GF3440-8AC13

Options

D/DO *)

- „Power supply DIO RS232“
10 m = 6GF3440-8BA2
30 m = 6GF3440-8BA4

Software

- Text-Genius
6GF3400-0SL01
Text-Genius Plus
6GF3400-1SL01
Veri-Genius
6GF3400-0SL02
Pat-Genius
6GF3400-0SL03

Web Interface

- Use additional IE cable
Various lengths available
2 m = 6XV1871-5TH20

Support

- Mounting plate
6GF3440-8CA
Tri-plate
6GF9002-7AD

Opt. for Lens rings

- 0.5, 1, 5, 10, 20, 40 mm
6GF9001-1BU
0.5, 1 mm
6GF9001-1BU01
length doubler
6GF9001-1BV

Filter

- infrared
6GF9001-2AD
blue
6GF9001-2AE
polarization
6GF9001-2AF
daylight
6GF3440-8EA1

Protective lens cover

- metal glas
6GF3440-8AC11
metal plastic
6GF3440-8AC21
plastic (included in basic model)
6GF3440-8AC12

Serial RS232



Simple text based protocol

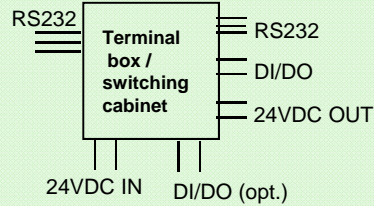

1 Reader per COM port may be connected
RS 232 cable for MV440 (open wires) +
 10 m = 6GF3440-8BA2
 30 m = 6GF3440-8BA4

Reader

With external power supply



Lens

- 6 mm (6GF9001-1BB01)
- 8,5 mm ** (6GF9001-1BE01)
- 12 mm (6GF9001-1BL01)
- 16 mm (6GF9001-1BF01)
- 25 mm (6GF9001-1BG01)
- 35 mm (6GF9001-1BH01)
- 50 mm (6GF9001-1BJ01)
- 75 mm ** *** (6GF9001-1BK01)



MV440

- SR; 640 x 480 pixel: (6GF3440-1CD10)
- HR; 1024 x 768 pixel: (6GF3440-1GE10)
- UR; 1600 x 1200 pixel: (6GF3440-1LE10)



Lights build-in

- red (6GF3440-8DA11)
- white (6GF3440-8DA21)
- green (6GF3440-8DA31)
- infrared (6GF3440-8DA41)



Lights external *)

- red (6GF3400-0LT01-8DA1)
- infrared (6GF3400-0LT01-7BA1)



Cable adapter M16/M12 (6GF3440-8BD1)

Or

Cable M12/open wire (6GF3440-8BC4)



Mounting plate (6GF3440-8CD01)

*) Additional power supply needed
 **) not in combination with build-in lights;
 ***) for protection order additional the tube extension 6GF3440-8AC13

Options

DI/DO *)

Wires included in RS232 / power supply cable
 Open wires

Software

- Text-Genius 6GF3400-0SL01
- Text-Genius Plus 6GF3400-1SL01
- Veri-Genius 6GF3400-0SL02
- Pat-Genius 6GF3400-0SL03

Web Interface

Use additional IE cable
 Various lengths available
 2 m = 6XV1871-5TH20

Support

- Mounting plate 6GF3440-8CA
- Tri-plate 6GF9002-7AD

Opt. for Lens rings

- 0.5, 1, 5, 10, 20, 40 mm 6GF9001-1BU
- 0.5, 1 mm 6GF9001-1BU01
- length doubler 6GF9001-1BV

Filter

- infrared 6GF9001-2AD
- blue 6GF9001-2AE
- polarization 6GF9001-2AF
- daylight 6GF3440-8EA1

Protective lens cover

- metal glas 6GF3440-8AC11
- metal plastic 6GF3440-8AC21
- plastic (included in basic model) 6GF3440-8AC12

MV320, MV325, MV340 System Interfaces

PC via USB



1 Reader per USB port may be connected

USB cable for MV320/ MV325/ MV340
The USB-cable (1,8 m) is included in the delivery scope

Reader

Powered through USB-cable



MV325 with Docking station
(6GF3325-0HT01)



MV320
(6GF3320-0HT01)



MV340
(6GF3340-0HT01)

Options



Docking station for MV325
(6GF3325-0AC03)

RF170C

ET200pro via PROFIBUS or PROFINET or S7 PLC

ET200pro PROFIBUS DP-V1 Interface module

+



ET200pro PROFIBUS Interface module

ET200pro PROFINET CPU module

Up to 9 x 170C modules per ET200pro rack



RF170C
Communication module (6GT2 002-0HD01)
Connection block (6GT2 002-1HD01)

A maximum of 2 readers may be connected

RS 232 cable for MV320
(6GT2191-0BH50)

or

A maximum of 2 readers may be connected

RS 232 cable for MV325/MV340
(6GT2191-0AH50)

Reader

Powered through connection cable



MV320
(6GF3320-0HT01)



MV340
(6GF3340-0HT01)

M3-Modem*
(6GF3325-0AC05)

+



MV325
(6GF3325-0HT01)



Spare Battery for MV325
(6GF3325-0AC07)



Metal stand for MV320
(6GF3320-0AC07)

RS232

For SIMATIC and other PLC



+



i.e. S7-1500 CPU

CM PtP RS 232 BA
(6ES7540-1AD00-0AA0)

power supply

Europe
(6GF3020-0AC40-0AP2)

US
(6GF3020-0AC40-0AP1)

1 Reader per RS232 port may be connected

RS 232 cable for MV320
6GF3320-0AC03

1 Reader per RS232 port may be connected

RS 232 cable for MV340
6GF3020-0AC40-0AC1

Reader

With external power supply



MV320
(6GF3320-0HT01)



MV340
(6GF3340-0HT01)

M3-Modem*
(6GF3325-0AC05)

+



MV325
(6GF3325-0HT01)

ASM 456 Bill of Materials Guide



The ASM 456 is a PROFIBUS DP-V1 interface module that can have one of two Connecting Blocks plugged into it: either ECOfast block (shown on the left in the photo) or the M12 block (shown on the right in the photo). Note that if an M12 block is chosen, a separate power supply cable with 7/8" connector must be included to power the block. After selecting a connector module, the designer chooses whether to purchase pre-made network cables or to make his/her own. Note that another design consideration is whether the ASM 456 is a PROFIBUS end-node or not. If it is an end-node, a Termination Resistor is required.

Description	Part Number	Notes
ASM456 Base	6GT2 002-0ED00	For PROFIBUS DP-V1 networks. 2 read/write devices or readers can be connected
Choose the Connecting Block type		
M12-7/8" Connecting Block	6ES7 194-3AA00-0BA0	M12 connectors as opposed to the ECOfast type. Both types are available for the ASM 456
ECOfast Connecting Block	6ES7 194-3AA00-0AA0	ECOfast connectors as opposed to the M12 type. Both types are available for the ASM 456
Make your own M12 PROFIBUS connection cables		
PROFIBUS M12 connector plug (5 per pack) with socket insert	6GK1 905-0EB00	For the supply side of the PROFIBUS network. Use Termination Resistor on the 2nd M12 port if ASM 456 is an end node
PROFIBUS M12 connector plug (5 per pack) with pin insert	6GK1 905-0EA00	For loop-through side of the PROFIBUS network. Both ports are used. No Termination Resistor needed for that ASM 456
PROFIBUS standard non-assembled cable	6XV1 830-0EH10	Sold by the meter Minimum length 20 m Maximum length 10000 m
M12 Termination Resistor for PROFIBUS (5 per pack)	6GK1 905-OEC00	Required if ASM 456 is an end-node
Use pre-made M12 PROFIBUS connection cables		
PROFIBUS cable with pre-assembled M12 connectors	6XV1 830-3Dxxx*	See Online Mail (http://mall.automation.siemens.com) Lengths available from 0.5 m up to 15 m
M12 Termination Resistor for PROFIBUS (5 per pack)	6GK1 905-OEC00	Required if ASM 456 is an end-node
Make your own ECOfast PROFIBUS connection cables		
PROFIBUS ECOfast connector plug (5 per pack) with socket insert	6GK1 905-0CB00	For the supply side of the PROFIBUS network. Use Termination Resistor on the 2nd ECOfast port if ASM 456 is an end node
PROFIBUS ECOfast connector plug (5 per pack) with pin insert	6GK1 905-0CA00	For loop-through side of the PROFIBUS network. Both ports are used. No Termination Resistor needed for that ASM 456
ECOfast Hybrid (both power and comm.) non-assembled cable	6XV1 830-7AN20 6XV1 830-7AN50 6XV1 830-7AT10	Sold by the meter (6XV1 830-7AH10) Or 20 m (-7AN20), 50 m (-7AN50), 100 m (-7AT10)
ECOfast Termination Resistor for PROFIBUS (1 per pack)	6GK1 905-0DA10	Required if ASM 456 is an end-node
Use pre-made ECOfast PROFIBUS connection cables		
PROFIBUS cable with pre-assembled ECOfast connectors	6XV1 830-7Bxxx*	See Online Mail (http://mall.automation.siemens.com) Lengths available from 0.5m up to 50m

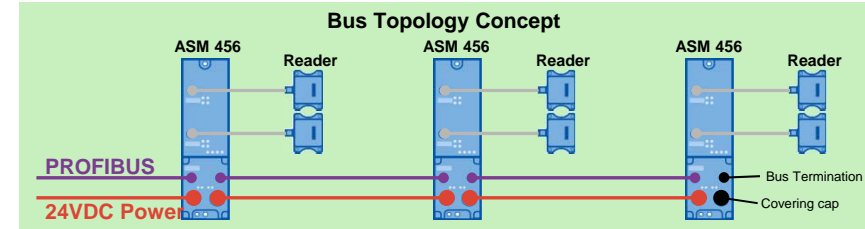

Description	Part Number	Notes
Make your own 7/8" power supply connection cables		
Power cable (5 wire, trailing type)	6XV1 830-8AH10	For the supply side of the 24VDC power; from 20 m up to 1000 m
Connector plug 7/8" for voltage (5 per pack) with socket insert	6GK1 905-0FB00	For the supply side of the 24VDC power (required for M12 connection blocks only)
Connector plug 7/8" for voltage (5 per pack) with pin insert	6GK1 905-0FA00	For the loop- trough of 24VDC power (required for M12 connection blocks only)
Use pre-made 7/8" power supply connection cables		
Cable for supply voltage with pre-assembled 7/8" connectors	6XV1 822-5Bxxx*	See Online Mail (http://mall.automation.siemens.com) Lengths available from 0.5 m up to 15 m
Make your own ASM 456 to Moby/RF reader cables		
Refer to the Bulk cable and connectors tables (Pages 62- 63)		
Use pre-made ASM 456 to MOBY/RF reader cables		
Reader cable MOBY D (without reader 6GT2 602-0AB10-0AX0)	6GT2 691-4FH20	2 meter pre-assembled cable
Reader cable R200/ RF300/ RF600 /MV440 and 6GT2 602-0AB10-0AX0 or Extension cable for RF200/ RF300/ RF600/MV400, MOBY D	6GT2 891-4FH20	2 meter pre-assembled cable
	6GT2 891-4FH50	5 meter pre-assembled cable
	6GT2 891-4FN10	10 meter pre-assembled cable
	6GT2 891-4FN20	20 meter pre-assembled cable
	6GT2 891-4FN50	50 meter pre-assembled cable
Reader cable MV420	6GF3420-0AC00-2CB0	2 meter pre-assembled cable
Additional components		
Covering caps for unused M12 (reader and network) ports	3RX9 802-0AA00	1 pack = 10 items
Covering caps for unused 7/8" (24VDC power) ports	6ES7 194-3JA00-0AA0	1 pack = 10 items
Connector for adjusting PROFIBUS address	6ES7 194-1KB00-0XA0	

* These cables are available in various lengths (see catalogue or mail)

RF160C Bill of Materials Guide



The RF160C is a PROFIBUS DP-V0 interface module that can have one of two Connecting Blocks plugged into it: either ECOfast block (shown on the left in the photo) or the M12 block (shown on the right in the photo). Note that if an M12 block is chosen, a separate power supply cable with 7/8" connector must be included to power the block. After selecting a connector module, the designer chooses whether to purchase pre-made network cables or to make his/her own. Note that another design consideration is whether the RF160C is a PROFIBUS end-node or not. If it is an end-node, a Termination Resistor is required.

Description	Part Number	Notes
RF160C Base	6GT2 002-0EF00	For PROFIBUS DP-V0 networks. 2 read/write devices or readers can be connected
Choose the Connecting Block type		
M12-7/8" Connecting Block	6ES7 194-3AA00-0BA0	M12 connectors as opposed to the ECOfast type. Both types are available for the RF160C
ECOfast Connecting Block	6ES7 194-3AA00-0AA0	ECOfast connectors as opposed to the M12 type. Both types are available for the RF160C
Make your own M12 PROFIBUS connection cables		
PROFIBUS M12 connector plug (5 per pack) with socket insert	6GK1 905-0EB00	For the supply side of the PROFIBUS network. Use Termination Resistor on the 2nd M12 port if RF160C is an end node
PROFIBUS M12 connector plug (5 per pack) with pin insert	6GK1 905-0EA00	For loop-through side of the PROFIBUS network. Both ports are used. No Termination Resistor needed for that RF160C
POFIBUS standard non-assembled cable	6XV1 830-0EH10	Sold by the meter Minimum length 20 m Maximum length 10000 m
M12 Termination Resistor for PROFIBUS (5 per pack)	6GK1 905-OEC00	Required if RF160C is an end-node
Use pre-made M12 PROFIBUS connection cables		
PROFIBUS cable with pre-assembled M12 connectors	6XV1 830-3Dxxx*	See Online Mall (http://mall.automation.siemens.com) Lengths available from 0.5 m up to 15 m
M12 Termination Resistor for PROFIBUS (5 per pack)	6GK1 905-0EC00	Required if RF160C is an end-node
Make your own ECOfast PROFIBUS connection cables		
PROFIBUS ECOfast connector plug (5 per pack) with socket insert	6GK1 905-0CB00	For the supply side of the PROFIBUS network. Use Termination Resistor on the 2nd ECOfast port if RF160C is an end node
PROFIBUS ECOfast connector plug (5 per pack) with pin insert	6GK1 905-0CA00	For loop-through side of the PROFIBUS network. Both ports are used. No Termination Resistor needed for that RF160C
ECOfast Hybrid (both power and comm.) non-assembled cable	6XV1 830-7AN20 6XV1 830-7AN50 6XV1 830-7AT10	Sold by the meter (6XV1830-7AH10) Or 20 m (-7AN20), 50 m (-7AN50), 100 m (-7AT10)
ECOfast Termination Resistor for PROFIBUS (1 per pack)	6GK1 905-0DA10	Required if RF160C is an end-node
Use pre-made ECOfast PROFIBUS connection cables		
PROFIBUS cable with pre-assembled ECOfast connectors	6XV1 830-7Bxxx*	See Online Mall (http://mall.automation.siemens.com) Lengths available from 0.5m up to 50m

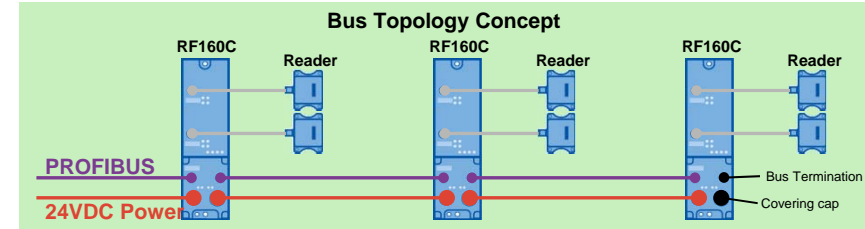

Description	Part Number	Notes
Make your own 7/8" power supply connection cables		
Power cable (5 wire, trailing type)	6XV1 830-8AH10	For the supply side of the 24VDC power; from 20 m up to 1000 m
Connector plug 7/8" for voltage (5 per pack) with socket insert	6GK1 905-0FB00	For the supply side of the 24VDC power (required for M12 connection blocks only)
Connector plug 7/8" for voltage (5 per pack) with pin insert	6GK1 905-0FA00	For the loop- trough of 24VDC power (required for M12 connection blocks only)
Use pre-made 7/8" power supply connection cables		
Cable for supply voltage with pre-assembled 7/8" connectors	6XV1 822-5Bxxx*	See Online Mall (http://mall.automation.siemens.com) Lengths available from 0.5 m up to 15 m
Make your own RF160C to Moby/RF reader cables		
Refer to the Bulk cable and connectors tables (Pages 62 - 63)		
Use pre-made RF160C to MOBY/RF reader cables		
Reader cable MOBY D (without reader 6GT2 602-0AB10-0AX0)	6GT2 691-4FH20	2 meter pre-assembled cable
Reader cable R200/ RF300/ RF600 /MV440 and 6GT2 602-0AB10-0AX0 or Extension cable for RF200/ RF300/ RF600/MV400, MOBY D	6GT2 891-4FH20	2 meter pre-assembled cable
	6GT2 891-4FH50	5 meter pre-assembled cable
	6GT2 891-4FN10	10 meter pre-assembled cable
	6GT2 891-4FN20	20 meter pre-assembled cable
	6GT2 891-4FN50	50 meter pre-assembled cable
Reader cable MV420	6GF3420-0AC00-2CB0	2 meter pre-assembled cable
Additional components		
Covering caps for unused M12 (reader and network) ports	3RX9 802-0AA00	1 pack = 10 items
Covering caps for unused 7/8" (24VDC power) ports	6ES7 194-3JA00-0AA0	1 pack = 10 items
Connector for adjusting PROFIBUS address	6ES7 194-1KB00-0XA0	

* These cables are available in various lengths (see catalogue or mall)

RF180C Bill of Materials Guide



The RF180C is a PROFINET interface module that can have one of two Connection Blocks plugged into it: either an M12-7/8" connection block or a Push Pull connection block plugged into it. This helps maintain its IP67 rating. Note that a separate power supply cable with 7/8" connector must be included to power the block. The designer chooses whether to purchase pre-made network cables or to make his/her own. Note that no Termination Resistors are required on end-nodes, but covering caps are highly recommended.

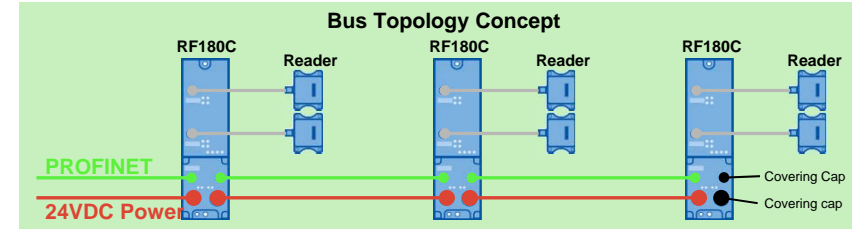

Description	Part Number	Notes
RF180C Base	6GT2 002-0JD00	For PROFIBUS networks. 2 read/write devices or readers can be connected
M12-7/8" Connecting Block	6GT2 002-1JD00	Connecting Block 4-pin M12 Ethernet, 5-pin 7/8" power
Push-Pull Connecting Block	6GT2 002-2JD00	Connection Block RJ45 in IP 67
Make your own M12 PROFINET connection cables		
SIMATIC NET Ethernet M12 4-pin connector	6GK1 901-0DB10-6AA0	Ethernet to connection Block. 2 x M12 4-pin connectors needed if loop-through
RJ45 connector with metal casing and DC connection system, 180° cable outlet	6GK1 901-1BB10-2AA0	For connection into standard RJ45-type Ethernet switch
ETHERNET industrial cable 2x2, Type A, unassembled	6XV1 840-2AH10	Sold by the meter Minimum length 20 m; Maximum length 1000 m
Use pre-made M12 PROFINET connection cables		
Pre-assembled PROFINET cable with 4-pin M12 on both ends	6XV1 870-8xxx*	0.3 m – 15 m pre-assembled cable
Make your own Push Pull PROFINET connection cable		
Push Pull RJ45 plug	6GK1 901-1BB10-6AA0	IP65 RJ45 connector
ETHERNET industrial cable 2x2, Type A, unassembled	6XV1 840-2AH10	Sold by the meter Minimum length 20 m; Maximum length 1000 m
Use pre-made Push Pull PROFINET connection cables		
At the moment not available from Siemens. Ask your Siemens distributor.		
Make your own 7/8" power supply connection cables		
For power to each comm. module, standard 4 connection TO cable can be used with 7/8" connectors.		
Power cable (5 wire, trailing type)	6XV1 830-8AH10	For the supply side of the 24 VDC power From 20m up to 1000m
Connector plug 7/8" for voltage (5 per pack) with socket insert	6GK1 905-0FB00	For the supply side of the 24 VDC power
Connector plug 7/8" for voltage (5 per pack) with pin insert	6GK1 905-0FA00	For the loop-through of 24 VDC power

Description	Part Number	Notes
Use pre-made 7/8" power supply connection cables		
Cable for supply voltage with pre-assembled 7/8" connectors	6XV1 822-5Bxxx	See Online Mall (http://mall.automation.siemens.com) Lengths available from 0.5 m up to 15 m
Make your own Push Pull power supply connection cables		
For power to each comm. module, standard 4-connection TO cable can be used with Push Pull connectors.		
Power cable (5 wire, trailing type)	6XV1 830-8AH10	For the supply side of the 24 VDC power; from 20m up to 1000m
Push Pull connector plug for 24VDC	6GK1 907-0AB10-6AA0	For the supply side of the 24 VDC power
Use pre-made Push Pull power supply connection cables		
At the moment not available from Siemens. Ask your Siemens distributor.		
Make your own RF180C to MOBY/RF reader cables		
Refer to the Bulk cable and connectors tables (Pages 62 - 63)		
Use pre-made RF180C to MOBY/RF reader cables		
Reader cable MOBY D; 2 m (without reader 6GT2 602-0AB10-0AX0)	6GT2 691-4FH20	2 meter pre-assembled cable
	6GT2 891-4FH20	2 meter pre-assembled cable
Reader cable R200/ RF300/ RF600 /MV440 and 6GT2 602-0AB10-0AX0 or Extension cable for RF200/ RF300/ RF600MV400, MOBY D	6GT2 891-4FH50	5 meter pre-assembled cable
	6GT2 891-4FN10	10 meter pre-assembled cable
	6GT2 891-4FN20	20 meter pre-assembled cable
	6GT2 891-4FN50	50 meter pre-assembled cable
Reader cable MV420	6GF3420-0AC00-2CB0	2 meter pre-assembled cable
Additional components		
Covering caps for unused 7/8" (24VDC power) ports	6ES7 194-3JA00-0AA0	1 pack = 10 items
Covering caps for unused M12 ports	3RX9 802-0AA00	1 pack = 10 items

* These cables are available in various lengths (see catalogue or mall)

RF182C Bill of Materials Guide



The RF182C is a Ethernet TCP/IP interface module that can have one of three Connection Blocks plugged into it: either an M12-7/8" Connection Block or a Push Pull connection block plugged into it. This helps maintain its IP67 rating. Note that a separate power supply cable with 7/8" connector must be included to power the block. The designer chooses whether to purchase pre-made network cables or to make his/her own. Note that no Termination Resistors are required on end-nodes, but covering caps are highly recommended.

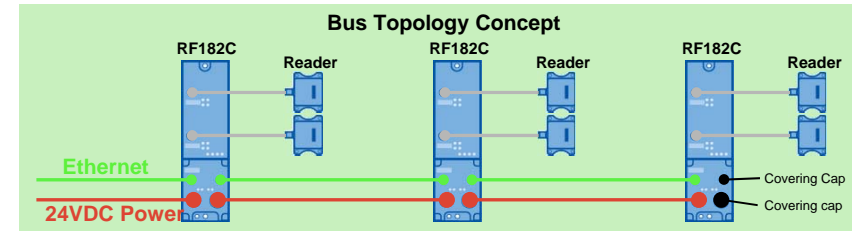

Description	Part Number	Notes
RF182C Base	6GT2 002-0JD10	For Ethernet networks. 2 read/write devices or readers can be connected
M12-7/8" (5-pin) Connecting Block	6GT2 002-1JD00	Connecting Block 4-pin M12 Ethernet, 5-pin 7/8" Power
Push-Pull Connecting Block	6GT2 002-2JD00	Connection Block RJ45 in IP 67
M12-7/8" (4-pin) Connecting Block	6GT2 002-4JD00	Connecting Block 4-pin M12 Ethernet, 4-pin 7/8" Power
Make your own M12 Ethernet connection cables		
SIMATIC NET Ethernet M12 4-pin connector	6GK1 901-0DB10-6AA0	Ethernet to Connection Block. 2x M12 4-pin connectors needed if loop-through
RJ45 connector with metal casing and DC connection system, 180° cable outlet	6GK1 901-1BB10-2AA0	For connection into standard RJ45-type Ethernet switch
ETHERNET industrial cable 2x2, Type A, unassembled	6XV1 840-2AH10	Sold by the meter Minimum length 20 m; Maximum length 1000 m
Use pre-made M12 Ethernet connection cables		
Pre-assembled PROFINET cable with 4-pin M12 on both ends	6XV1 870-8xxx*	0.3 m – 15 m pre-assembled cable
Make your own Push Pull Ethernet connection cable		
Push Pull RJ45 plug	6GK1 901-1BB10-6AA0	IP65 RJ45 connector
ETHERNET industrial cable 2x2, Type A, unassembled	6XV1 840-2AH10	Sold by the meter Minimum length 20 m; Maximum length 1000 m
Use pre-made Push Pull Ethernet connection cables		
At the moment not available from Siemens. Ask your Siemens distributor.		
Make your own 7/8" power supply connection cables with 5-pin plug		
Power cable (5 wire, trailing type)	6XV1 830-8AH10	For the supply side of the 24VDC power; from 20 m up to 1000 m
Connector plug 7/8" for voltage (5 per pack) with socket insert	6GK1 905-0FB00	For the supply side of the 24VDC power
Connector plug 7/8" for voltage (5 per pack) with pin insert	6GK1 905-0FA00	For the loop-through of 24VDC power
Use pre-made 7/8" power supply connection cables with 5-pin plug		
Cable for supply voltage with pre-assembled 7/8" connectors	6XV1 822-5Bxxx*	See Online Mall (Length 0.5 m to 15 m) (http://mall.automation.siemens.com)

Description	Part Number	Notes
Make your own Push Pull power supply connection cables		
Power cable (5 wire, trailing type)	6XV1 830-8AH10	For the supply side of the 24 VDC power; from 20 m up to 1000 m
Push Pull Connector plug for 24VDC	6GK1 907-0AB10-6AA0	For the supply side of the 24 VDC power
Use pre-made Push Pull power supply connection cables		
At the moment not available from Siemens. Ask your Siemens distributor.		
Make your own 7/8" power supply connection cables with 4-pin plug		
Power cable (5 wire, trailing type)	6XV1 830-8AH10	For the supply side of the 24VDC power from 20 m up to 1000 m
Connector plug 7/8" for voltage With 4 socket insert	Not available from Siemens.	See Note 4 on page 63; Binder sells 7/8" plugs . Their part No. 99 2442 12 04 fits to conn. block
Use pre-made 7/8" power supply connection cables with 4-pin plug		
Not available from Siemens.		
Make your own RF182C to MOBY/RF reader cables		
Refer to the Bulk cable and connectors tables (Pages 62 – 63)		
Use pre-made RF182C to MOBY/RF reader cables		
Reader cable MOBY D; 2 m (Without reader 6GT2 602-0AB10-0AX0)	6GT2 691-4FH20	2 meter pre-assembled cable
Reader cable R200/ RF300/ RF600/ MV440 and 6GT2 602-0AB10-0AX0 or Extension cable for RF200/ RF300/ RF600/ MV400, MOBY D	6GT2 891-4FH20	2 meter pre-assembled cable
	6GT2 891-4FH50	5 meter pre-assembled cable
	6GT2 891-4FN10	10 meter pre-assembled cable
	6GT2 891-4FN20	20 meter pre-assembled cable
	6GT2 891-4FN50	50 meter pre-assembled cable
Reader cable MV420	6GF3420-0AC00-2CB0	2 meter pre-assembled cable
Additional components		
Covering caps for unused 7/8" (24VDC power) ports	6ES7 194-3JA00-0AA0	1 pack = 10 items
Covering caps for unused M12 ports	3RX9 802-0AA00	1 pack = 10 items

* These cables are available in various lengths (see catalogue or mall)

RFID 181EIP Bill of Materials Guide



The RFID 181EIP is an Ethernet/IP (Rockwell protocol) interface module that can have one of two Connection Blocks plugged into it: either an M12-7/8" 5-pin Connection Block or an M12-7/8" 4-pin Connection Block plugged into it. This helps maintain its IP67 rating. Note that a separate power supply cable with 7/8" connector must be included to power the block. The designer chooses whether to purchase pre-made network cables or to make his/her own. Note that no Termination Resistors are required on end-nodes, but covering caps are highly recommended.

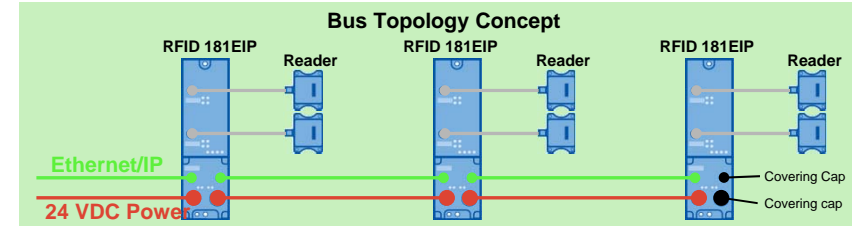

Description	Part Number	Notes
RFID 181EIP Base	6GT2 002-0JD20	For Ethernet/IP networks, 2 read/ write devices or readers can be connected
M12-7/8" (5-pin) Connecting Block	6GT2 002-1JD00	Connecting Block 4-pin M12 Ethernet, 5-pin 7/8" Power
M12-7/8" (4-pin) Connecting Block	6GT2 002-4JD00	Connecting Block 4-pin M12 Ethernet, 4-pin 7/8" Power
Make your own M12 Ethernet/IP connection cables		
SIMATIC NET Ethernet M12 4-pin connector	6GK1 901-0DB10-6AA0	Ethernet to Connection Block. 2 x M12 4-pin connectors needed if loop-through
RJ45 connector with metal casing and DC connection system, 180° cable outlet	6GK1 901-1BB10-2AA0	For connection into standard RJ45-type Ethernet switch
ETHERNET industrial cable 2x2, Type A, unassembled	6XV1 840-2AH10	Sold by the meter Minimum length 20 m Maximum length 1000 m
Use pre-made M12 Ethernet/IP connection cables		
Pre-assembled Ethernet cable with 4-pin M12 on both ends	6XV1 870-8xxx	0.3 m– 15 m pre-assembled cable
Make your own 7/8" power supply connection cables with 5-pin plug		
Power cable (5 wire, trailing type)	6XV1 830-8AH10	For the supply side of the 24VDC power from 20 m up to 1000 m
Connector plug 7/8" for voltage (5 per pack) with socket insert	6GK1 905-0FB00	For the supply side of the 24VDC power (For 5-pin 7/8" connection block only)
Connector plug 7/8" for voltage (5 per pack) with pin insert	6GK1 905-0FA00	For the loop-through of 24VDC power (For 5-pin 7/8" connection block only)
Use pre-made 7/8" power supply connection cables with 5-pin plug		
Cable for supply voltage with pre-assembled 7/8" connectors	6XV1 822-5Bxxx*	See Online Mall (http://mall.automation.siemens.com) (For 5-pin 7/8" connection block only)
Make your own 7/8" Power supply connection cables with 4-pin plug		
Power cable (5 wire, trailing type)	6XV1 830-8AH10	For the supply side of the 24VDC power from 20 m up to 1000 m
Connector plug 7/8" for voltage with 4 socket insert	Not available from Siemens	See Note 4 on page 63: Binder sells 7/8" plugs . Their part No. 99 2442 12 04 fits to conn. block
Use pre-made 7/8" power supply connection cables with 4-pin plug		
Not available from Siemens.		

Description	Part Number	Notes
Make your own RFID 181EIP to MOBY/RF reader cables		
Refer to the Bulk cable and connectors tables (Pages 62 - 63)		
Use pre-made RFID 181EIP to MOBY/RF reader cables		
Reader cable MOBY D; 2 m (with out reader 6GT2 602-0AB10-0AX0)	6GT2 691-4FH20	2 meter pre-assembled cable
Reader cable R200/ RF300/ RF600 /MV440 and 6GT2 602-0AB10-0AX0 or Extension cable for RF200/ RF300/ RF600/ MV400, MOBY D	6GT2 891-4FH20	2 meter pre-assembled cable
	6GT2 891-4FH50	5 meter pre-assembled cable
	6GT2 891-4FN10	10 meter pre-assembled cable
	6GT2 891-4FN20	20 meter pre-assembled cable
	6GT2 891-4FN50	50 meter pre-assembled cable
Reader cable MV420	6GF3420-0AC00-2CB0	2 meter pre-assembled cable
Additional components		
Covering cabs for unused 7/8" (24VDC power) ports	6ES7 194-3JA00-0AA0	1 pack = 10 items
Covering cabs for unused M12 ports	3RX9 802-0AA00	1 pack = 10 items

* These cables are available in various lengths (see catalogue or mall)

Bulk Cable and Connectors



	ASM 456/ RF160C	RF120C	ASM 475	RS232 to PC	Ethernet to PC	RF170C	RF180C,RF182C, RFID 181EIP
MOBY D							
SLG D1x	Not applicable	Not applicable	Not applicable	6GT2 090-4AN50 (50 m cable) 6GT2 090-4AT12 (120 m cable) 6GT2 090-4AT80 (800 m cable) 6GT2 490-1AA00 (SLG connector) 6GT2 490-1AA00 (PC connector)	Not applicable	Not applicable	Not applicable
SLG D1xS	6GT2 090-4AN50 (50 m cable) 6GT2 090-4AT12 (120 m cable) 6GT2 090-4AT80 (800 m cable) 6GT2 490-1AA00 (SLG connector) 6GT2090-0BE00 (CM connector)	6GT2 090-4AN50 (50 m cable) 6GT2 090-4AT12 (120 m cable) 6GT2 090-4AT80 (800 m cable) 6GT2 490-1AA00 (SLG connector) 9-pin submin-D/M (CM connector) ³	6GT2 090-4AN50 (50 m cable) 6GT2 090-4AT12 (120 m cable) 6GT2 090-4AT80 (800 m cable) 6GT2 490-1AA00 (SLG connector)	Not applicable	Not applicable	6GT2 090-4AN50 (50 m cable) 6GT2 090-4AT12 (120 m cable) 6GT2 090-4AT80 (800 m cable) 6GT2 490-1AA00 (SLG connector) 6GT2090-0BE00 (CM connector)	6GT2 090-4AN50 (50 m cable) 6GT2 090-4AT12 (120 m cable) 6GT2 090-4AT80 (800 m cable) 6GT2 490-1AA00 (SLG connector) 6GT2090-0BE00 (CM connector)
RF200							
RF2x0R (IO-Link)	For IP 20 Master with screws or push in: Always use reader-side assembled cables: 1,5 m = 3RK1902-4HB15-5AA0; 5 m = 6GT2 891-4LH50; 10 m = 6GT2 891-4LN10 No further connector required			For IP 67 Master with M12: Use reader-side assembled cables: 1,5 m = 3RK1902-4HB15-5AA0; 5 m = 6GT2 891-4LH50; 10 m = 6GT2 891-4LN10 Connector for IO-Link Master: 3RK1902-4BA00-5AA0 (straight) or 3RK1902-4DA00-5AA0 (angled)			
RF2X0R RF210M (RS422) (CM type)	6GT2 090-4AN50 (50 m cable) 6GT2 090-4AT12 (120 m cable) 6GT2 090-4AT80 (800 m cable) 6GT2090-0BD00 (reader connector) 6GT2090-0BE00 (CM connector)	6GT2 090-4AN50 (50 m cable) 6GT2 090-4AT12 (120 m cable) 6GT2 090-4AT80 (800 m cable) 6GT2090-0BD00 (reader connector) 9-pin submin-D/M (CM connector) ³	6GT2090-4AN50 (50 m cable) 6GT2090-4AT12 (120 m cable) 6GT2090-4AT80 (800 m cable) 6GT2090-0BD00 (reader connector) 20-pin S7-300 (CM connector)	6GT2 090-4AN50 (50 m cable) 6GT2 090-4AT12 (120 m cable) 6GT2 090-4AT80 (800 m cable) 6GT2090-0BD00 (reader connector) PC side: interface converter RS422/ RS232	Not applicable	6GT2 090-4AN50 (50 m cable) 6GT2 090-4AT12 (120 m cable) 6GT2 090-4AT80 (800 m cable) 6GT2090-0BD00 (reader connector) 6GT2090-0BE00 (CM connector)	6GT2 090-4AN50 (50 m cable) 6GT2 090-4AT12 (120 m cable) 6GT2 090-4AT80 (800 m cable) 6GT2090-0BD00 (reader connector) 6GT2090-0BE00 (CM connector)
RF240R RF250R RF260R (RS232)	Not applicable	Not applicable	Not applicable	6GT2 090-4AN50 (50 m cable) 6GT2 090-4AT12 (120 m cable) 6GT2 090-4AT80 (800 m cable) 6GT2090-0BD00 (reader connector) 6GT2 490-1AA00 (PC connector)	Not applicable	Not applicable	Not applicable
RF300							
RF3x0R (RS422) (CM type)	6GT2 090-4AN50 (50 m cable) 6GT2 090-4AT12 (120 m cable) 6GT2 090-4AT80 (800 m cable) 6GT2090-0BD00 (reader connector) 6GT2090-0BE00 (CM connector)	6GT2 090-4AN50 (50 m cable) 6GT2 090-4AT12 (120 m cable) 6GT2 090-4AT80 (800 m cable) 6GT2090-0BD00 (reader connector) 9-pin submin-D/M (CM connector) ³	6GT2090-4AN50 (50 m cable) 6GT2090-4AT12 (120 m cable) 6GT2090-4AT80 (800 m cable) 6GT2090-0BD00 (reader connector) 20-pin S7-300 (CM connector)	6GT2 090-4AN50 (50 m cable) 6GT2 090-4AT12 (120 m cable) 6GT2 090-4AT80 (800 m cable) 6GT2090-0BD00 (reader connector) PC side: interface converter RS422/ RS232	Not applicable	6GT2 090-4AN50 (50 m cable) 6GT2 090-4AT12 (120 m cable) 6GT2 090-4AT80 (800 m cable) 6GT2090-0BD00 (reader connector) 6GT2090-0BE00 (CM connector)	6GT2 090-4AN50 (50 m cable) 6GT2 090-4AT12 (120 m cable) 6GT2 090-4AT80 (800 m cable) 6GT2090-0BD00 (reader connector) 6GT2090-0BE00 (CM connector)
RF38xR (RS232)	Not applicable	Not applicable	Not applicable	6GT2 090-4AN50 (50 m cable) 6GT2 090-4AT12 (120 m cable) 6GT2 090-4AT80 (800 m cable) 6GT2090-0BD00 (reader connector) 6GT2 490-1AA00 (PC connector)	Not applicable	Not applicable	Not applicable
RF600							
RF650R	Not applicable	Not applicable	Not applicable	Not applicable	6XV1 840-2AH10 (>20 m cable) 6GK1901-1BB10-2AA0 (RJ45, reader connector + network connector)	Not applicable	Not applicable
RF680R/ RF685R	6GT2 090-4AN50 (50 m cable) 6GT2 090-4AT12 (120 m cable) 6GT2 090-4AT80 (800 m cable) 6GT2090-0BD00 (reader connector) 6GT2090-0BE00 (CM connector)	Not applicable	Not applicable	Not applicable	6XV1 840-2AH10 (>20 m cable) 6GK1901-0DB20-6AA0 (IM12 Plug, reader connector) 6GK1901-1BB10-2AA0 (RJ45, network connector)	Not applicable	Not applicable

Bulk Cable and Connectors

	ASM 456/ RF160C	RF120C	ASM 475	RS232 to PC	Ethernet to PC	RF170C	RF180C, RF182C, RFID 181EIP	
RF600								
RF620R/ RF630R	6GT2 090-4AN50 (50 m cable) 6GT2 090-4AT12 (120 m cable) 6GT2 090-4AT80 (800 m cable) 6GT2090-0BD00 (reader connector) 6GT2090-0BE00 (CM connector)	6GT2 090-4AN50 (50 m cable) 6GT2 090-4AT12 (120 m cable) 6GT2 090-4AT80 (800 m cable) 6GT2090-0BD00 (reader connector) 9-pin submin-D/M (CM connector) ³	6GT2 090-4AN50 (50 m cable) 6GT2 90-4AT12 (120 m cable) 6GT2 090-4AT80 (800 m cable) 6GT2090-0BD00 (reader connector) 20-pin S7-300 (CM connector)	6GT2 090-4AN50 (50 m cable) 6GT2 090-4AT12 (120 m cable) 6GT2 090-4AT80 (800 m cable) 6GT2090-0BD00 (reader connector) PC side: interface converter RS422/RS232	Not applicable	6GT2 090-4AN50 (50 m cable) 6GT2 090-4AT12 (120 m cable) 6GT2 090-4AT80 (800 m cable) 6GT2090-0BD00 (reader connector) 6GT2090-0BE00 (CM connector)	6GT2 090-4AN50 (50 m cable) 6GT2 090-4AT12 (120 m cable) 6GT2 090-4AT80 (800 m cable) 6GT2090-0BD00 (reader connector) 6GT2090-0BE00 (CM connector)	
MV400								
MV420	6GT2 090-4AN50 (50 m cable) 6GT2 090-4AT12 (120 m cable) 6GT2 090-4AT80 (800 m cable) 12-pin M16/F (reader connector) ⁴ 6GT2090-0BE00 (CM connector)	6GT2 090-4AN50 (50 m cable) 6GT2 090-4AT12 (120 m cable) 6GT2 090-4AT80 (800 m cable) 12-pin M16/F (reader connector) ⁴ 9-pin submin-D/M (CM connector) ³	6GT2 090-4AN50 (50 m cable) 6GT2 90-4AT12 (120 m cable) 6GT2 090-4AT80 (800 m cable) 12-pin M16/F (reader connector) ⁴ 20-pin S7-300 (CM connector)	6GT2 090-4AN50 (50 m cable) 6GT2 090-4AT12 (120 m cable) 6GT2 090-4AT80 (800 m cable) 12-pin M16/F (reader connector) ⁴ 6GT2 490-1AA00 (PC connector)	6XV1 840-2AH10 (>20 m) 6GK1 901-0DB20-6AA0 (4-pin M12 d coded, reader connector) 6GK1901-1BB10-2AA0 (RJ45, network connector)	6GT2 090-4AN50 (50 m cable) 6GT2 090-4AT12 (120 m cable) 6GT2 090-4AT80 (800 m cable) 12-pin M16/F (reader connector) ⁴ 6GT2090-0BE00 (CM connector)	6GT2 090-4AN50 (50 m cable) 6GT2 090-4AT12 (120 m cable) 6GT2 090-4AT80 (800 m cable) 12-pin M16/F (reader connector) ⁴ 6GT2090-0BE00 (CM connector)	
MV440	6GT2 090-4AN50 (50 m cable) 6GT2 090-4AT12 (120 m cable) 6GT2 090-4AT80 (800 m cable) 6GT2090-0BD00 (reader connector) 6GT2090-0BE00 (CM connector)	6GT2 090-4AN50 (50 m cable) 6GT2 090-4AT12 (120 m cable) 6GT2 090-4AT80 (800 m cable) 6GT2090-0BD00 (reader connector) 9-pin submin-D/M (CM connector) ³	6GT2 090-4AN50 (50 m cable) 6GT2 90-4AT12 (120 m cable) 6GT2 090-4AT80 (800 m cable) 6GT2090-0BD00 (reader connector) 20-pin S7-300 (CM connector)	6GT2 090-4AN50 (50 m cable) 6GT2 090-4AT12 (120 m cable) 6GT2 090-4AT80 (800 m cable) 12-pin M16/F (reader connector) ⁴ 6GT2 490-1AA00 (PC connector)	6XV1 840-2AH10 (>20 m) 6GK1 901-0DB20-6AA0 (4-pin M12 d coded, reader connector) 6GK1901-1BB10-2AA0 (RJ45, network connector)	6GT2 090-4AN50 (50 m cable) 6GT2 090-4AT12 (120 m cable) 6GT2 090-4AT80 (800 m cable) 6GT2090-0BD00 (reader connector) 6GT2090-0BE00 (CM connector)	6GT2 090-4AN50 (50 m cable) 6GT2 090-4AT12 (120 m cable) 6GT2 090-4AT80 (800 m cable) 6GT2090-0BD00 (reader connector) 6GT2090-0BE00 (CM connector)	
Power & Control-side Networking Components								
	ASM 456/ RF160C	RF120C	ASM 475	RS232 to PC	RF170C	RF180C, RF182C, RFID 181EIP	RF68xR, RF650R	MV420, MV440
Cable & Connectors	See ASM 456 / RF160C Bill of Materials Guide Page 57, 58	Direct with S7-1200 assembly	Direct in S7-300 rack or in ET 200M rack using IM153-2 Module	See individual readers above	A tool called TIA Selection Tool is available for configuring the ET 200pro. You will find the tool on the Internet at: http://www.siemens.com/tia-selection-tool-standalone .	See RF180C, RF182C & RFID181EIP Bill of materials guide page 59, 60, 61	6GT2 090-4AN50 (50 m cable) 6GT2 090-4AT12 (120 m cable) 6GT2 090-4AT80 (800 m cable) 6GT2090-0BD00 (reader connector) 6GK1907-0DB10-6AA3 (power supply)	6GT2 090-4AN50 (50 m cable) 6GT2 090-4AT12 (120 m cable) 6GT2 090-4AT80 (800 m cable) 12-pin M16/F (reader connector) ⁴

Notes:

- Certain readers and interface modules (ie. SLG D1x, SLG D1xS) have a separate 24VDC supply connection, thus have an onboard male M12 power connector. As an alternative to using a pre-made cable with the Wide Range Power Supply, one could use a female M12 and appropriate 4-conductor cable (pins 1&4 = 0 VDC, pins 2&3 = 24 VDC) to power these components:
 - Female 4-pin connector (1 per pack) 6GT2 390-1AB00
- Order via distributor for electronic components
- Binder M12, M16 and 7/8" male & female connectors for making custom interface cables.. They almost have screw terminals inside of them for wire connections, so they're easy to build in the field. The contact info is:

Binder-USA – LP offices and warehouse 3903 Calle Tecate, Camarillo, CA93012 PHONE: (805) 437-9925 EMAIL: mailto:sales@binder-usa.com Web site = http://www.binder-usa.com	Binder Europa Rötelstrasse 27 74172 Neckarsulm PHONE: ++49 (0) 71 32 - 325-0 EMAIL: vk@binder-connector.de Web site: http://www.binder-connector.de	Binder Asia 南京江宁开发区诚信大道88号, 7号楼 PHONE: 025-83328591 EMAIL: mailto:bindernj@binder-connector.cn Web site: http://www.binder-connector.cn	Binder Order example for RF68xR DI/DO/power/RS232 connector: M16 cable connector 12-pin, female wire solder: 99 5630 00 12
Binder Order example for 7/8" power cable connector: 7/8" cable connector 4-pin, male with screws: 99 2443 12 04 7/8" cable connector 4-pin, female with screws: 99 2442 12 04			