

# SIEMENS

## SIMATIC NET

### Industrial Ethernet Switches SCALANCE X-300

#### Compact Operating Instructions

<u>Introduction</u>	<b>1</b>
<u>Safety instructions</u>	<b>2</b>
<u>Description</u>	<b>3</b>
<u>Assembling</u>	<b>4</b>
<u>Connecting</u>	<b>5</b>
<u>Technical data</u>	<b>6</b>
<u>Dimension drawings</u>	<b>7</b>
<u>Certifications and approvals</u>	<b>8</b>

## Legal information

### Warning notice system

This manual contains notices you have to observe in order to ensure your personal safety, as well as to prevent damage to property. The notices referring to your personal safety are highlighted in the manual by a safety alert symbol, notices referring only to property damage have no safety alert symbol. These notices shown below are graded according to the degree of danger.

#### **DANGER**

indicates that death or severe personal injury **will** result if proper precautions are not taken.

#### **WARNING**

indicates that death or severe personal injury **may** result if proper precautions are not taken.

#### **CAUTION**

indicates that minor personal injury can result if proper precautions are not taken.

#### **NOTICE**

indicates that property damage can result if proper precautions are not taken.

If more than one degree of danger is present, the warning notice representing the highest degree of danger will be used. A notice warning of injury to persons with a safety alert symbol may also include a warning relating to property damage.

### Qualified Personnel

The product/system described in this documentation may be operated only by **personnel qualified** for the specific task in accordance with the relevant documentation, in particular its warning notices and safety instructions. Qualified personnel are those who, based on their training and experience, are capable of identifying risks and avoiding potential hazards when working with these products/systems.

### Proper use of Siemens products

Note the following:

#### **WARNING**

Siemens products may only be used for the applications described in the catalog and in the relevant technical documentation. If products and components from other manufacturers are used, these must be recommended or approved by Siemens. Proper transport, storage, installation, assembly, commissioning, operation and maintenance are required to ensure that the products operate safely and without any problems. The permissible ambient conditions must be complied with. The information in the relevant documentation must be observed.

### Trademarks

All names identified by ® are registered trademarks of Siemens AG. The remaining trademarks in this publication may be trademarks whose use by third parties for their own purposes could violate the rights of the owner.

### Disclaimer of Liability

We have reviewed the contents of this publication to ensure consistency with the hardware and software described. Since variance cannot be precluded entirely, we cannot guarantee full consistency. However, the information in this publication is reviewed regularly and any necessary corrections are included in subsequent editions.

# Table of contents

<b>1</b>	<b>Introduction</b> .....	<b>5</b>
1.1	X-300 product group .....	6
1.2	Type designations .....	8
<b>2</b>	<b>Safety instructions</b> .....	<b>11</b>
2.1	Use of approved components.....	11
2.2	Important notes on using the SCALANCE X-300 product family .....	12
2.3	Important notes on using the device in hazardous areas .....	14
2.4	PELV .....	14
<b>3</b>	<b>Description</b> .....	<b>15</b>
3.1	Unpacking and checking.....	15
3.2	Components of the product .....	15
3.3	Product variants X-300 .....	16
3.3.1	SCALANCE X304-2FE .....	16
3.3.2	SCALANCE X306-1LD FE.....	17
3.3.3	SCALANCE X307-3 .....	18
3.3.4	SCALANCE X307-3LD .....	19
3.3.5	SCALANCE X308-2 .....	20
3.3.6	SCALANCE X308-2LD .....	21
3.3.7	SCALANCE X308-2LH .....	22
3.3.8	SCALANCE X308-2LH+ .....	23
3.3.9	SCALANCE X310 .....	24
3.3.10	SCALANCE X310FE.....	25
3.3.11	SCALANCE X320-1FE .....	26
3.3.12	SCALANCE X320-3LD FE.....	27
3.4	The SET / SELECT button.....	28
3.5	LED display .....	29
3.6	C-PLUG .....	32
3.6.1	Area of application and function of the C-PLUG.....	32
3.6.2	Removing and inserting the C-PLUG (compact housing).....	33
<b>4</b>	<b>Assembling</b> .....	<b>35</b>
4.1	Safety notices for installation .....	35
4.2	Suitable installation location at temperatures above 50 °C .....	35
4.3	Suitable cables for temperatures in excess of 70 °C (ATEX).....	36
4.4	Suitable cables for temperatures above 70 °C - cable 50 °C - 70 °C (ATEX).....	36
4.5	Installation.....	37
4.6	Installation on a DIN rail.....	38

4.7	Installation on a standard rail .....	40
4.8	Wall mounting .....	41
<b>5</b>	<b>Connecting .....</b>	<b>43</b>
5.1	Safety when connecting up.....	43
5.2	Wiring rules .....	45
5.3	Connecting the switch .....	45
5.4	Connecting functional ground .....	46
5.5	24 VDC signaling contact.....	47
5.6	Power supply.....	48
5.6.1	24 VDC - product group X-300 .....	48
5.6.2	Power supply.....	48
<b>6</b>	<b>Technical data .....</b>	<b>51</b>
6.1	Construction, installation and environmental conditions.....	51
6.2	Connectors and electrical data .....	53
6.3	Cable lengths .....	56
6.4	Other properties .....	57
<b>7</b>	<b>Dimension drawings.....</b>	<b>61</b>
7.1	Dimension drawing .....	61
<b>8</b>	<b>Certifications and approvals .....</b>	<b>67</b>
8.1	X-300 approvals, certificates.....	67
8.2	SCALANCE X-300 declaration of conformity.....	71
8.3	X-300 FDA and IEC approvals.....	71
8.4	Overview of the X-300 approvals.....	72
8.5	X-300 mechanical stability (in operation).....	72
	<b>Index .....</b>	<b>75</b>

# Introduction

## Purpose of the Operating Instructions (compact)

These operating instructions (compact) contain information with which you will be able to install and connect up a device of the SCALANCE X-300 product line.

## Validity of these Operating Instructions (compact)

These Operating Instructions (compact) are valid for the product group **X-300** of the SCALANCE X-300 product line (see product overview).

## Names of the devices in these operating instructions (compact)

Classification	Description	Terms used
Product line	For all devices and variants of all product groups within the SCALANCE X-300 product line, the term <b>IE switches X-300</b> is used.	<b>IE switches X-300</b>
Product group	For all devices and variants of a product group, only the product group is used.	<b>X-300</b>
Device	For a device, only the device name is used.	<b>X306-1LD FE</b>
Variant	For a variant of the device, the device name has the appropriate variant added to it in brackets (2x24V).	(-)
All variants of a device	For all variants of the device, the device name has (all) added to it.	(-)

## Where can I find more detailed information on the product?

A CD is supplied with the IE Switches X-300 on which you will find a detailed description of the products in PDF format in the relevant subfolder.

## Security messages

### Note

Siemens offers IT security mechanisms for its automation and drive product portfolio in order to support the safe operation of the plant/machine. Our products are also continuously developed further with regard to IT security. We therefore recommend that you regularly check for updates of our products and that you only use the latest versions. You will find information in:

(<http://support.automation.siemens.com/WW/llisapi.dll?func=cslib.csinfo2&aktprim=99&lang=en>)

Here, you can register for a product-specific newsletter.

For the safe operation of a plant/machine, however, it is also necessary to integrate the automation components into an overall IT security concept for the entire plant/machine, which corresponds to the state-of-the-art IT technology. You will find information on this in:

(<http://www.siemens.com/industrialsecurity>)

Products from other manufacturers that are being used must also be taken into account.

## SIMATIC NET glossary

Explanations of many of the specialist terms used in this documentation can be found in the SIMATIC NET glossary.

You will find the SIMATIC NET glossary here:

- SIMATIC NET Manual Collection or product DVD  
The DVD ships with certain SIMATIC NET products.
- On the Internet under the following address:  
50305045 (<http://support.automation.siemens.com/WW/view/en/50305045>)

## 1.1 X-300 product group

Device	Properties	Order number
X304-2FE	4 x 10/100 Mbps RJ-45 ports electrical 2 x 1000 Mbps, SC ports optical, for glass FO cable (multimode), up to max. 750 m	6GK5 304-2BD00-2AA3
X306-1LD FE	6 x 10/100 Mbps RJ-45 ports electrical 1 x 100 Mbps, SC port optical, for glass FO cable (single mode), up to max. 26 km	6GK5 306-1BF00-2AA3
X307-3	7 x 10/100 Mbps RJ-45 ports electrical 3 x 1000 Mbps, SC ports optical, for glass FO cable (multimode), up to max. 750 m	6GK5 307-3BL00-2AA3 6GK5 307-3BL10-2AA3

Device	Properties	Order number
<b>X307-3LD</b>	7 x 10/100 Mbps RJ-45 ports electrical 3 x 1000 Mbps, SC ports optical, for glass FO cable (single mode), up to max. 10 km	6GK5 307-3BM00-2AA3 6GK5 307-3BM10-2AA3
<b>X308-2</b>	1 x 10/100/1000 Mbps, RJ-45 ports electrical 7 x 10/100 Mbps RJ-45 ports electrical 2 x 1000 Mbps, SC ports optical, for glass FO cable (multimode), up to max. 750 m	6GK5 308-2FL00-2AA3 6GK5 308-2FL10-2AA3
<b>X308-2LD</b>	1 x 10/100/1000 Mbps, RJ-45 ports electrical 7 x 10/100 Mbps RJ-45 ports electrical 2 x 1000 Mbps, SC ports optical, for glass FO cable (single mode), up to max. 10 km	6GK5 308-2FM00-2AA3 6GK5 308-2FM10-2AA3
<b>X308-2LH</b>	1 x 10/100/1000 Mbps, RJ-45 ports electrical 7 x 10/100 Mbps RJ-45 ports electrical 2 x 1000 Mbps, SC ports optical, for glass FO cable (single mode), up to max. 40 km	6GK5 308-2FN00-2AA3 6GK5 308-2FN10-2AA3
<b>X308-2LH+</b>	1 x 10/100/1000 Mbps, RJ-45 ports electrical 7 x 10/100 Mbps RJ-45 ports electrical 2 x 1000 Mbps, SC ports optical, for glass FO cable (single mode), up to max. 70 km	6GK5 308-2FP00-2AA3 6GK5 308-2FP10-2AA3
<b>X310</b>	3 x 10/100/1000 Mbps, RJ-45 ports electrical 7 x 10/100 Mbps RJ-45 ports electrical	6GK5 310-0FA00-2AA3 6GK5 310-0FA10-2AA3
<b>X310FE</b>	10 x 10/100 Mbps RJ-45 ports electrical	6GK5 310-0BA00-2AA3 6GK5 310-0BA10-2AA3
<b>X320-1FE</b>	20 x 10/100 Mbps RJ-45 ports electrical 1 x 100 Mbps, SC port optical, for glass FO cable (multimode), up to max. 5 km	6GK5 320-1BD00-2AA3
<b>X320-3LD FE</b>	20 x 10/100 Mbps RJ-45 ports electrical 1 x 100 Mbps, SC port optical, for glass FO cable (multimode), up to max. 5 km 2 x 100 Mbps, SC ports optical, for glass FO cable (single mode), up to max. 26 km	6GK5 320-3BF00-2AA3

## 1.2 Type designations

### Structure of the type designation

The type designation of an IE Switch X-300 is made up of several parts that have the following meaning:

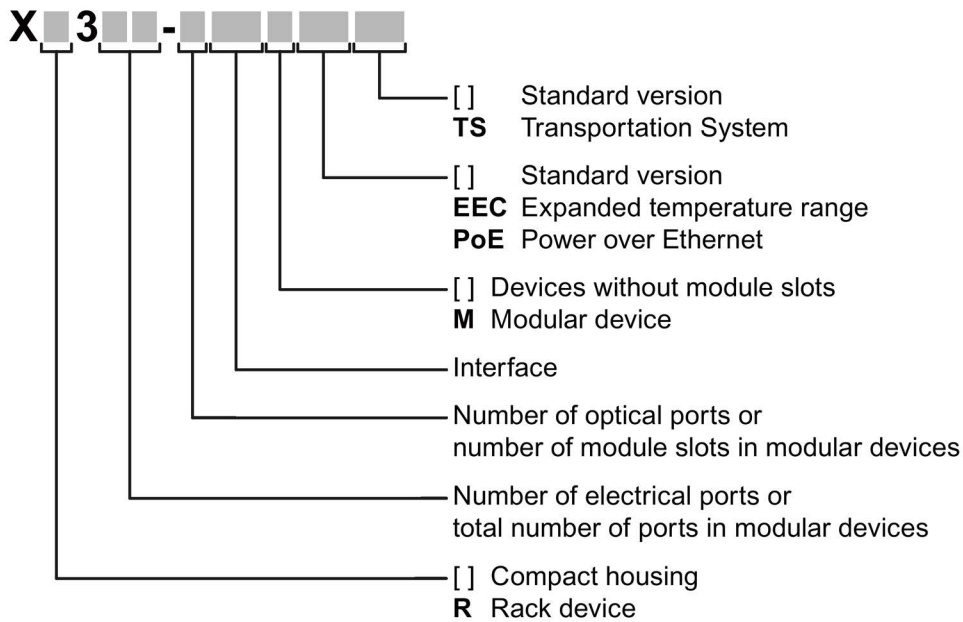

Interfaces of devices without optical ports:

Interface	Property
FE	Electrical RJ-45 port for 10/100 Mbps.
[-]	Electrical RJ-45 port for 10/100 Mbps or 10/100/1000 Mbps.

Interfaces of devices with optical ports:

Interface	Property
FE	SC port 100 Mbps multimode FO cable (up to max. 5 km).
LD FE	SC port 100 Mbps single mode FO cable (up to max. 26 km).
[-]	SC port 1000 Mbps multimode FO cable (up to max. 750 m).
LD	SC port 1000 Mbps single mode FO cable (up to max. 10 km).
LH	SC port 1000 Mbps single mode FO cable (up to max. 40 km).
LH+	SC port 1000 Mbps single mode FO cable (up to max. 70 km).



If information applies to all devices, the term "IE Switches X-300" is used. If information applies to only a particular product group, the relevant names will be used without extra information on the type or number of interfaces. Examples: "X-300" stands for non-modular devices with a compact housing, "XR-300" means all rack devices, "X-300M" means all modular devices etc.

---

**Note****SCALANCE X320-3LD FE**

The SCALANCE X320-3LD FE deviates from the type designation in that it has an SC port for multimode fiber-optic cable up to a maximum of 5 km in length and two SC ports for single mode fiber-optic cable up to a maximum of 26 km in length.

- Port 21: Multimode
- Port 22: LD (long distance, single mode)
- Port 23: LD (long distance, single mode)

**2 optical interface transceivers possible**

The device is also equipped with 2 optical interface transceivers.

- <sup>1</sup> (Fast Ethernet, long distance interface)
- <sup>2</sup> (Fast Ethernet, multimode interface)

Refer to "Transmitter output optical" and "Receiver input" in the technical specifications.

---



## Safety instructions

### Read the safety notices

Note the following safety notices. These relate to the entire working life of the device.

You should also read the safety notices relating to handling in the individual sections, particularly in the sections "Installation" and "Connecting up".

### 2.1 Use of approved components

 <b>WARNING</b>
<p><b>Use of approved components</b></p> <ul style="list-style-type: none"> <li>• Use only approved components, for example supporting brackets, SFPs, 19 inch racks.</li> <li>• Create any supports you require according the dimension drawing.</li> </ul>

### Safety notices on use in hazardous areas

#### General safety notices relating to protection against explosion

 <b>WARNING</b>
<p><b>EXPLOSION HAZARD</b></p> <p>DO NOT OPEN WHEN ENERGIZED.</p>

#### Safety notices when using the device according to Hazardous Locations (HazLoc)

If you use the device under HazLoc conditions you must also keep to the following safety notices in addition to the general safety notices for protection against explosion:

This equipment is suitable for use in Class I, Division 2, Groups A, B, C and D or non-hazardous locations only.

This equipment is suitable for use in Class I, Zone 2, Group IIC or non-hazardous locations only.

## 2.2 Important notes on using the SCALANCE X-300 product family

### Safety notices on the use of the device

The following safety notices must be adhered to when setting up and operating the device and during all associated work such as installation, connecting up, replacing or opening the device.

### General information

 **WARNING**

**Safety extra low voltage**

The equipment is designed for operation with Safety Extra-Low Voltage (SELV) by a Limited Power Source (LPS). (This does not apply to 100 V...240 V devices.)

This means that only SELV / LPS (Limited Power Source) complying with IEC 60950-1 / EN 60950-1 / VDE 0805-1 must be connected to the power supply terminals. The power supply unit for the equipment power supply must comply with NEC Class 2, as described by the National Electrical Code (r) (ANSI / NFPA 70).

If the equipment is connected to a redundant power supply (two separate power supplies), both must meet these requirements.

A power source that supplies safety extra low voltage combined with a following NEC Class 2 power limiter also meets the requirements according to IEC 60950-1 / EN 60950-1 / VDE 0805-1 or NEC Class 2. A suitable power limiter is for example the redundancy module SITOP PSE202U NEC Class 2 (article number 6EP1962-2BA00).

 **WARNING**

**Opening the device**

DO NOT OPEN WHEN ENERGIZED.

### General notices about use in hazardous areas

 **WARNING**

**Risk of explosion when connecting or disconnecting the device**

EXPLOSION HAZARD

DO NOT CONNECT OR DISCONNECT EQUIPMENT WHEN A FLAMMABLE OR COMBUSTIBLE ATMOSPHERE IS PRESENT.

** WARNING****Replacing components**

EXPLOSION HAZARD

SUBSTITUTION OF COMPONENTS MAY IMPAIR SUITABILITY FOR CLASS I, DIVISION 2 OR ZONE 2.

** WARNING****Requirements for the cabinet/enclosure**

When used in hazardous environments corresponding to Class I, Division 2 or Class I, Zone 2, the device must be installed in a cabinet or a suitable enclosure.

**Safety notices on use in hazardous areas according to ATEX and IECEx**** WARNING****Requirements for the cabinet/enclosure**

To comply with EC Directive 94/9 (ATEX95) or the conditions of IECEx, this enclosure must meet the requirements of at least IP54 in compliance with EN 60529.

** WARNING****Suitable cables for temperatures in excess of 70 °C**

If the cable or conduit entry point exceeds 70 °C or the branching point of conductors exceeds 80 °C, special precautions must be taken. If the equipment is operated in an air ambient in excess of 50 °C - 70 °C, only use cables with admitted maximum operating temperature of at least 80 °C.

** WARNING****Protection against transient voltage surges**

Provisions shall be made to prevent the rated voltage from being exceeded by transient voltage surges of more than 40%. This criterion is fulfilled, if supplies are derived from SELV (Safety Extra-Low Voltage) only.

## 2.3 Important notes on using the device in hazardous areas

 <b>WARNING</b>
<b>WARNING - EXPLOSION HAZARD -</b> DO NOT DISCONNECT WHILE CIRCUIT IS LIVE UNLESS AREA IS KNOWN TO BE NON-HAZARDOUS.

 <b>WARNING</b>
<b>Restricted area of application</b> This equipment is suitable for use in Class I, Division 2, Groups A, B, C and D or non-hazardous locations only.

 <b>WARNING</b>
<b>Restricted area of application</b> This equipment is suitable for use in Class I, Zone 2, Group IIC or non-hazardous locations only.

## 2.4 PELV

---

### Note

#### Safety extra-low voltage

The supply of the devices by PELV (Protective Extra Low Voltage) according to DIN VDE 0100-410 or IEC 60364-4-41 is permitted when the generated nominal voltage does not exceed the voltage limits 25 VAC or 60 VDC.

---

## Description

### 3.1 Unpacking and checking

#### Unpacking, checking

 **WARNING**

**Do not use any parts that show evidence of damage**

If you use damaged parts, there is no guarantee that the device will function according to the specification.

If you use damaged parts, this can lead to the following problems:

- Injury to persons
- Loss of the approvals
- Violation of the EMC regulations

Use only undamaged parts.

1. Make sure that the package is complete.
2. Check all the parts for transport damage.

### 3.2 Components of the product

The following components are supplied with a SCALANCE X-300:

- Device with C-PLUG exchangeable medium.
- A four-pin terminal block for the 24 VDC power supply.
- A two-pin terminal block for the signaling contact.
- Product CD with documentation and software.

### 3.3 Product variants X-300

#### 3.3.1 SCALANCE X304-2FE

##### Possible attachments

The SCALANCE X304-2FE provides the following options for the connection of end devices or other network segments:

- 4 RJ-45 jacks
- 2 FO ports (for multimode fiber)



Image 3-1 X304-2FE

Column	1	2
Port number	P1	P3
		P4
	P2	P5
		P6
Connection type	Optical: Fast Ethernet	Electrical: Fast Ethernet



### 3.3.2 SCALANCE X306-1LD FE

#### Possible attachments

The SCALANCE X306-1LD FE provides the following options for the connection of end devices or other network segments:

- 6 RJ-45 jacks
- 1 FO port (for single mode fiber)



Image 3-2 SCALANCE X306-1LD FE

Column	1	2
Port number	P1 *)	P4
		P5
	P2	P6
	P3	P7
Connection type	Electrical: Fast Ethernet *) Optical: Fast Ethernet	Electrical: Fast Ethernet

### 3.3.3 SCALANCE X307-3

#### Possible attachments

The SCALANCE X307-3 provides the following options for the connection of end devices or other network segments:

- 7 RJ-45 jacks
- 3 FO ports (for multimode fiber)



Image 3-3 SCALANCE X307-3

Column	1	2	3	4
Port number	P1	P5	P8	P9
	P2	P6		
	P3	P7	-	P10
	P4	-		
Connection type	Electrical: Fast Ethernet		Optical: Gigabit Ethernet	

### 3.3.4 SCALANCE X307-3LD

#### Possible attachments

The SCALANCE X306-3LD provides the following options for the connection of end devices or other network segments:

- 7 RJ-45 jacks
- 3 FO ports (for single mode fiber)



Image 3-4 SCALANCE X307-3LD

Column	1	2	3	4
Port number	P1	P5	P8	P9
	P2	P6		
	P3	P7	-	P10
	P4	-		
Connection type	Electrical: Fast Ethernet		Optical: Gigabit Ethernet	

### 3.3.5 SCALANCE X308-2

#### Possible attachments

The SCALANCE X308-2 provides the following options for the connection of end devices or other network segments:

- 8 RJ-45 jacks
- 2 FO ports (for multimode fiber)



Image 3-5 SCALANCE X308-2

Column	1	2	3	4
Port number	P1	P5	P8	P9
	P2	P6	-	
	P3	P7	-	P10
	P4	-	-	
Connection type	Electrical: Fast Ethernet		Electrical: Gigabit Ethernet	Optical: Gigabit Ethernet

### 3.3.6 SCALANCE X308-2LD

#### Possible attachments

The SCALANCE X308-2LD provides the following options for the connection of end devices or other network segments:

- 8 RJ-45 jacks
- 2 FO ports (for single mode fiber)



Image 3-6 SCALANCE X308-2LD

Column	1	2	3	4
Port number	P1	P5	P8	P9
	P2	P6	-	
	P3	P7	-	P10
	P4	-	-	
Connection type	Electrical: Fast Ethernet		Electrical: Gigabit Ethernet	Optical: Gigabit Ethernet

### 3.3.7 SCALANCE X308-2LH

#### Possible attachments

The SCALANCE X308-2LH provides the following options for the connection of end devices or other network segments:

- 8 RJ-45 jacks
- 2 FO ports (for single mode fiber)



Image 3-7 SCALANCE X308-2LH

Column	1	2	3	4
Port number	P1	P5	P8	P9
	P2	P6	-	
	P3	P7	-	P10
	P4	-	-	
Connection type	Electrical: Fast Ethernet		Electrical: Gigabit Ethernet	Optical: Gigabit Ethernet

### 3.3.8 SCALANCE X308-2LH+

#### Possible attachments

The SCALANCE 308-2LH+ provides the following options for the connection of end devices or other network segments:

- 8 RJ-45 jacks
- 2 FO ports (for single mode fiber)



Image 3-8 SCALANCE X308-2LH+

Column	1	2	3	4
Port number	P1	P5	P8	P9
	P2	P6	-	
	P3	P7	-	P10
	P4	-	-	
Connection type	Electrical: Fast Ethernet		Electrical: Gigabit Ethernet	Optical: Gigabit Ethernet

### 3.3.9 SCALANCE X310

#### Possible attachments

The SCALANCE X310 provides the following options for the connection of end devices or other network segments:

- 10 RJ-45 jacks



Image 3-9 SCALANCE X310

Column	1	2	3	4
Port number	P1	P5	P8	P9
	P2	P6	-	P10
	P3	P7	-	-
	P4	-	-	-
Connection type	Electrical: Fast Ethernet		Electrical: Gigabit Ethernet	



### 3.3.10 SCALANCE X310FE

#### Possible attachments

The SCALANCE X310FE provides the following options for the connection of end devices or other network segments:

- 10 RJ-45 jacks



Image 3-10 SCALANCE X310FE

Column	1	2	3	4
Port number	P1	P5	P8	P9
	P2	P6	-	P10
	P3	P7	-	-
	P4	-	-	-
Connection type	Electrical: Fast Ethernet			

### 3.3.11 SCALANCE X320-1FE

#### Possible attachments

The SCALANCE X320-1 FE provides the following options for the connection of end devices or other network segments:

- 20 RJ-45 jacks
- 1 FO port (for multimode fiber)



Image 3-11 SCALANCE X320-1 FE

Column	1	2	3	4	5	6
Port number	P1	P5	P9	P13	P17	P21
	P2	P6	P10	P14	P18	-
	P3	P7	P11	P15	P19	-
	P4	P8	P12	P16	P12	-
Connection type	Electrical: Fast Ethernet					Optical: Fast Ethernet

### 3.3.12 SCALANCE X320-3LD FE

#### Possible attachments

The SCALANCE X320-3LD FE provides the following options for the connection of end devices or other network segments:

- 20 RJ-45 jacks
- 1 FO port (for multimode fiber)
- 2 FO ports (for single mode fiber)



Image 3-12 SCALANCE X320-3LD FE

Column	1	2	3	4	5	6
Port number	P1	P5	P9	P13	P17	P21
	P2	P6	P10	P14	P18	P22
	P3	P7	P11	P15	P19	P23
	P4	P8	P12	P16	P20	-
Connection type	Electrical: Fast Ethernet					Optical: Fast Ethernet

## 3.4 The SET / SELECT button

The SET/SELECT button is located on the top of the housing of devices of the X-300 EEC series. On all other devices, this button is on the front panel of the housing beside the LED display. The SET/SELECT button has several functions that are described below.

### Change the display mode

By pressing the button briefly, you change to the display mode of the LED display. For more detailed information on this topic, refer to the section "LED display".

### Resetting the device to the factory defaults

If you reset, all the changes you have made will be overwritten by factory defaults. Follow the steps outlined below:

1. Turn on display mode A. Display mode A is active when the "DM" LED is not lit. If this LED is lit or flashing, you will need to press the SET/SELECT briefly (possibly several times) until the "DM" LED goes off. If the SELECT/SET button is not pressed for longer than a minute, the device also turns on display mode A.
2. Hold down the SELECT/SET button for 12 seconds. If you release the button before the 12 seconds have elapsed, the reset is canceled.

### Definition of the fault mask

Using the fault mask, you specify an individual "good status" for the connected ports and the power supply. Deviations from this status are then displayed as errors/faults.

1. Turn on display mode A or D. Display mode A is active when the "DM" LED is not lit. Display mode D is active when the "DM" LED flashes yellow/orange. If a different display mode is active, you will need to press the SET/SELECT briefly (possibly several times) until the required display mode is active.
2. Hold down the SET/SELECT button for five seconds. After three seconds, the "DM" LED begins to flash. If you release the button before the five seconds have elapsed, the previous fault mask will be retained.

### Enable/disable the redundancy manager

1. Turn on display mode B. Display mode B is active when the "DM" LED is lit green. If a different display mode is active, you will need to press the SET/SELECT briefly (possibly several times) until display mode B is active.
2. Hold down the SET/SELECT button for five seconds. After three seconds, the "DM" LED begins to flash. If you release the button before the five seconds have elapsed, the action is aborted.
3. The result of the action depends on the initial situation:
  - If the redundancy manager and media redundancy were disabled, media redundancy is also enabled after enabling the redundancy manager.
  - If you disable the redundancy manager, media redundancy remains enabled.

## 3.5 LED display

### The "RM" LED for the "redundancy manager" function

The "RM" LED indicates whether or not the device is operating in the role of redundancy manager and whether or not the ring is operating error-free.

LED color	LED status	Meaning
-	off	The device is not operating in the role of "redundancy manager".
green	on	The device is operating in the role of redundancy manager. The ring is working without problems, monitoring is activated.
green	flashes	The device is operating in the role of redundancy manager. An interruption has been detected on the ring and the device has switched through.

### The "SB" LED for the standby function

This LED shows the status of the standby function.

LED color	LED status	Meaning
-	off	The standby function is disabled.
green	on	The standby function is enabled. The standby section is passive.
green	flashes	The standby function is enabled. The standby section is active.

### The "F" LED for the fault status

The "F" LED (fault) provides information on the error/fault status of the device. While the device is starting up, this LED has the following meaning:

LED color	LED status	Meaning during the device startup
-	off	Device startup completed successfully.
red	on	Device startup not yet completed or a fault/error has occurred.
red	flashes	Bad firmware image.

During normal operation, the "F" LED provides the following information:

LED color	LED status	Meaning during operation
-	off	No operating problems.
red	on	The device has detected an error. The signaling contact opens.

### The "DM" LED for the display mode

The "DM" LED (Display Mode) indicates which of the four display modes A, B, C or D is currently active. The meaning of the L1, L2 and P1, P2, ... LEDs depends on the display mode.

LED color	LED status	Meaning
-	off	Display mode <b>A</b>
green	on	Display mode <b>B</b>
orange	on	Display mode <b>C</b>
yellow/orange	flashes	Display mode <b>D</b>

### Selecting the display mode

Press the SELECT/SET button to set the required display mode. If the SELECT/SET button is not pressed for longer than a minute, the device automatically changes to display mode A.

Pressing the SELECT/SET button starting at display mode A	Status of the "DM" LED	Display mode
-	off	Display mode <b>A</b> (default mode)
Press once	lit green	Display mode <b>B</b>
Press twice	lit orange	Display mode <b>C</b>
Press 3 times	flashes yellow/orange	Display mode <b>D</b>

### The "L1" and "L2" or "L" LEDs for the power supply

Whereas on other devices, the "L1" and "L2" LEDs indicate information about the power, on the SCALANCE X306-1LD FE, this is done by the "L" LED. A redundant power supply for this device can be recognized by the color of the LED.

#### Meaning in display mode A, B or C

LED	Color	Status	Meaning
L1 / L2	-	off	Power supply L1 / L2 lower than 17 V *)
	green	on	Power supply L1 / L2 higher than 17 V *)
L	-	off	Power supplies L1 and L2 less than 17 V or not connected.
	orange	on	Power supply L1 or L2 higher than 17 V (no redundant supply).
	green	on	Power supplies L1 and L2 higher than 17 V (redundant supply).

\*) The following applies to the X-300EEC:

- For devices with power supply unit 24 to 48 VDC: Limit voltage = 17 VDC
- For devices with a multiple range power supply unit 100 to 240 VAC / 60 to 250 VDC: Limit voltage = 46.5 VDC or 80 VAC

### Meaning in display mode D

LED	Color	Status	Meaning
L1 / L2	-	off	Power supply L1 / L2 is not monitored. If L1 / L2 falls below 17 V <sup>*)</sup> , the signaling contact does not respond.
	green	on	Power supply L1 / L2 is monitored. If L1 / L2 falls below 17 V <sup>*)</sup> , the signaling contact responds.
L	-	off	Power supplies L1 and L2 are not monitored. If L1 or L2 falls below 17 V, the signaling contact does not respond.
	orange	on	Power supply L1 or L2 is monitored. If L1 or L2 falls below 17 V, the signaling contact responds.
	green	on	Power supplies L1 and L2 are monitored. If L1 and L2 fall below 17 V, the signaling contact responds.
<p><sup>*)</sup>) The following applies to the X-300EEC:</p> <ul style="list-style-type: none"> <li>• For devices with power supply unit 24 to 48 VDC: Limit voltage = 17 VDC</li> <li>• For devices with a multiple range power supply unit 100 to 240 VAC / 60 to 250 VDC: Limit voltage = 46.5 VDC or 80 VAC</li> </ul>			

### Note

#### Devices of the X-300EEC product group

When using only one power supply unit 24 VDC and two 24 VDC power supplies, the LEDs "L1" and "L2" signal the existence of the power supply L1 and L2.

When using two 24 VDC power supply units, the LEDs "L1" and "L2" signal the existence of the primary voltage and the secondary voltage for both power supply units. If the power supply is intact, a fault occurring on a power supply unit on the secondary side can be recognized.

### The P1, P2, ... LEDs for the port status

The P1, P2, ... LEDs show information on the status of their port (transmission speed, mode, port monitoring). The meaning of these LEDs depends on the display mode ("DM" LED).

#### Meaning in display mode A

LED color	LED status	Meaning
-	off	No valid link to the port (for example station turned off or cable not connected).
green	on	Link exists and port in normal status. In this status, the port can receive and send data.
	flashes once per second	Link exists and port in "blocking" status. In this status, the port only sends and receives management data (no user data).
	flashes 3 times per second	Link exists and port turned off by management. In this status, no data is sent or received via the port.
	flashes 4 times per second	Port exists and is in the "monitor port" status. In this status, the data traffic of another port is mirrored to this port.

LED color	LED status	Meaning
yellow	flashes / lit	Receiving data at port. With SCALANCE X-300 devices, both the receipt and the sending of data is indicated for the optical gigabit ports.

#### Meaning in display mode B

LED color	LED status	Meaning
-	off	Port operating at 10 Mbps.
green	on	Port operating at 100 Mbps.
orange	on	Port operating at 1000 Mbps.

If there is a problem on the connection and the type of transmission is fixed (autonegotiation off), the desired status, in other words the set transmission speed (1000 Mbps, 100 Mbps, 10 Mbps) continues to be displayed. If there is a problem on the connection and autonegotiation is active, the port LED goes off.

#### Meaning in display mode C

LED color	LED status	Meaning
-	off	Port operating in half duplex.
green	on	Port operating in full duplex.

#### Meaning in display mode D

LED color	LED status	Meaning
-	off	The port is not monitored; in other words, if a link is not established at the port, this does not trigger the signaling contact.
green	on	The port is monitored, in other words, if no connection was established at the port (for example no cable inserted), this triggers the signaling contact and an error state results.

## 3.6 C-PLUG

### 3.6.1 Area of application and function of the C-PLUG

#### Area of application

The C-PLUG (configuration plug) that ships with the product is an exchangeable memory medium for storing the configuration data of the device. The device can also be operated without a C-PLUG.

This allows fast and uncomplicated replacement of a device. The C-PLUG is taken from the previous device and inserted in the new device. The first time it is started up, the



replacement device has the same configuration as the previous device except for the MAC address set by the vendor.

## Principle

The data remains stored on the C-PLUG even when power is turned off. In terms of using the C-PLUG, there are two ways of operating the device:

- With unwritten C-PLUG

If an empty C-PLUG (factory settings or deleted with the Clean function) is inserted, all the configuration data of the device is saved to it automatically when the device starts up. Changes to the configuration during operation are saved without operator intervention on the C-PLUG if this is in the "ACCEPTED" status. This depends on how you configured your SCALANCE device. In this mode, the internal memory is neither read nor written. This mode is active when a C-PLUG is inserted.

- With written C-PLUG

A device with an accepted C-PLUG inserted uses the configuration data of the C-PLUG automatically when it starts up. Acceptance is possible only when the data was written by a compatible device type.

## Response to errors

Inserting a C-PLUG that does not contain the configuration of a compatible device type, accidentally removing the C-PLUG or general malfunctions of the C-PLUG are signaled by the diagnostics mechanisms of the device (LEDs, Web-based management, SNMP, CLI and PROFINET diagnostics).

### 3.6.2 Removing and inserting the C-PLUG (compact housing)

<b>NOTICE</b>
A C-PLUG may only be removed or inserted when the device is turned off.

### Position of the C-PLUG



In devices with a compact housing, the C-PLUG is located behind the sealing screw on the rear of the device. To remove the sealing screw, use a coin or a wide blade screwdriver.

### Removing the C-PLUG

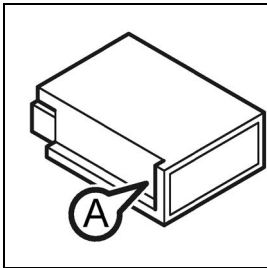

1. Turn off the power to the device.
2. Remove the sealing screw on the rear of the device with a coin or a wide blade screwdriver.
3. Insert a screwdriver between the front edge of the C-PLUG (position A) and the slot and release the C-PLUG.
4. Remove the C-PLUG and close the housing again with the sealing screw.

### Inserting the C-PLUG

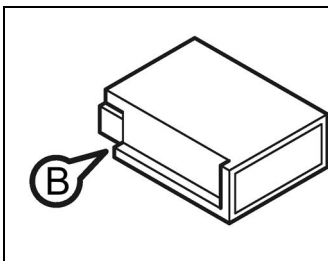

1. Turn off the power to the device.
2. Remove the sealing screw on the rear of the device with a coin or a wide blade screwdriver.
3. The housing of the C-PLUG has a protruding ridge on the long side (position B). The slot has a groove at this position. Insert the C-PLUG correctly oriented into the slot.
4. Close the housing again with the sealing screw.

# Assembling

## 4.1 Safety notices for installation

### Safety notices

When installing the device, keep to the safety notices listed below.

## 4.2 Suitable installation location at temperatures above 50 °C

 <b>WARNING</b>
<b>Suitable installation location at temperatures above 50 °C</b>
If a device is operated in an ambient temperature of more than 50 °C, the temperature of the device housing may be higher than 70 °C.
When installing the device, select a location where only qualified service personnel or trained users have access to it.

### Safety notices on use in hazardous areas

#### General safety notices relating to protection against explosion

 <b>WARNING</b>
<b>EXPLOSION HAZARD</b>
The replacement of components may impair suitability for Class 1, Division 2 or zone 2.

 <b>WARNING</b>
The device may only be operated in an environment with pollution degree 1 or 2 (see IEC 60664-1).

 <b>WARNING</b>
When used in hazardous environments corresponding to Class I, Division 2 or Class I, Zone 2, the device must be installed in a cabinet or a suitable enclosure.

4.3 Suitable cables for temperatures in excess of 70 °C (ATEX)

**Safety notices for use according to ATEX and IECEx**

If you use the device under ATEX or IECEx conditions you must also keep to the following safety notices in addition to the general safety notices for protection against explosion:

 **WARNING**

To comply with EC Directive 2014/34/EU (ATEX 114) or the conditions of IECEx, this enclosure or cabinet must meet the requirements of at least IP54 in compliance with EN 60529.

4.3 Suitable cables for temperatures in excess of 70 °C (ATEX)

 **WARNING**

If the cable or conduit entry point exceeds 70 °C or the branching point of conductors exceeds 80 °C, special precautions must be taken. If the equipment is operated in an air ambient in excess of 50 °C, only use cables with admitted maximum operating temperature of at least 80 °C.

4.4 Suitable cables for temperatures above 70 °C - cable 50 °C - 70 °C (ATEX)

 **WARNING**

If the temperature of the cable or housing socket exceeds 70 °C or the branching point of conductors exceeds 80 °C, special precautions must be taken. If the equipment is operated in an air ambient in excess of 50 °C to 70 °C, only use cables with a permitted operating temperature of at least 80 °C.

## 4.5 Installation

 **WARNING**

**Suitable installation location at temperatures above 50 °C**

If a device is operated in an ambient temperature of more than 50 °C, the temperature of the device housing may be higher than 70 °C.

When installing the device, select a location where only qualified service personnel or trained users have access to it.

 **WARNING**

**Use of approved components**

- Use only approved components, for example supporting brackets, SFPs, 19 inch racks.
- Create any supports you require according the dimension drawing.

 **WARNING**

**Suitable cables for temperatures in excess of 70 °C**

If the cable or conduit entry point exceeds 70 °C or the branching point of conductors exceeds 80 °C, special precautions must be taken. If the equipment is operated in an air ambient in excess of 50 °C, only use cables with admitted maximum operating temperature of at least 80 °C.

 **CAUTION**

Provide suitable shade to protect the IE Switch X-300 against direct sunlight. This avoids unnecessary warming of the IE Switches X-300 and prevents premature aging of the IE Switch X-300 and cabling.

**Note**

When installing and operating the device, keep to the installation instructions and safety-related notices as described in this document and in the manual SIMATIC NET Industrial Ethernet Twisted Pair and Fiber Optic Networks.

## 4.6 Installation on a DIN rail

**⚠ WARNING**

**When used in shipbuilding, installation on a 35mm DIN rail is not permitted.**

The 35 mm DIN rail (DIN EN 60715) does not provide adequate support in shipping or when there is severe vibration ( $> 10$  g). Under such conditions, the device can come out of the mounting and may cause injury.

In such situations, install the device on an S7-300 standard rail.

**Valid only for the appropriately marked devices in the various product groups.** This is indicated by a note in the Installation options table. Refer to the relevant table in the section Technical specification (subsection, construction, installation and environment).

### Installation

Install the IE Switch X-300 on a 35 mm DIN rail complying with DIN EN 60715.

1. Hang the IE Switch X-300 on the DIN rail and then push it in against the rail until it clips into place.
2. Fit the connectors for the power supply.
3. Fit the connectors for the signaling contact.
4. Insert the terminal blocks into the sockets on the IE Switch X-300.



Image 4-1 Mounting an IE Switch X-300 on a DIN rail (35 mm)

## Removing

To remove an IE Switch X-300 from the DIN rail:

1. Disconnect all cables from the switch.
2. Release the lower part of the IE Switch X-300 from the DIN rail with a screwdriver and pull the lower part of the switch away from the DIN rail.



Image 4-2 Removing an IE Switch X-300 from a DIN rail (35 mm)

## Removing an IE Switch X-300

1. Push the X-300 down.
2. Swing the device upwards.

No tools are necessary for removing the device.

## 4.7 Installation on a standard rail

### Installation on a SIMATIC S7-300 standard rail

1. Place the upper guide at the top of the IE Switch X-300 housing in the S7 standard rail.
2. Screw the IE Switch X-300 to the underside of the standard rail.
3. Fit the connectors for the power supply.
4. Fit the connectors for the signaling contact.
5. Insert the terminal blocks into the sockets on the IE Switch X-300.



Image 4-3 IE Switch X-300 installation on a SIMATIC S7-300 standard rail

### Uninstalling

To remove an IE Switch X-300 from the SIMATIC S7-300 standard rail:

1. First disconnect all connected cables.
2. Loosen the screws on the underside of the S7 standard rail and lift the IE Switch X-300 away from the rail.



## 4.8 Wall mounting

### Wall mounting

1. For wall mounting, use suitable mounting fittings for the wall (for example, for a concrete wall, four plugs 6 mm diameter and 30 mm long, 4 screws 3.5 mm diameter and 40 mm long).
2. Connect the electrical cable connecting cables.
3. Fit the connectors for the signaling contact.
4. Insert the terminal blocks into the sockets on the IE Switch X-300.

---

**Note**

For more exact dimensions, please refer to the section "Dimension drawings".

---

**Note**

The wall mounting must be capable of supporting at least four times the weight of the IE Switch X-300.

---

**Note**

For wall mounting of a rack device (R), use suitable fittings and mount the device as shown in the drawing.

---



# Connecting

## 5.1 Safety when connecting up

### Safety notices

When connecting up the device, keep to the safety notices listed below.

 <b>WARNING</b>
<p>The equipment is designed for operation with Safety Extra-Low Voltage (SELV) by a Limited Power Source (LPS).</p> <p>This means that only SELV / LPS complying with IEC 60950-1 / EN 60950-1 / VDE 0805-1 must be connected to the power supply terminals. The power supply unit for the equipment power supply must comply with NEC Class 2, as described by the National Electrical Code (r) (ANSI / NFPA 70).</p> <p>If the equipment is connected to a redundant power supply (two separate power supplies), both must meet these requirements.</p>

<b>NOTICE</b>
<p><b>Failure of the data traffic due to contamination of optical plug-in connections</b></p> <p>Optical sockets and plugs are sensitive to contamination of the end face. Contamination can lead to the failure of the optical transmission network.</p> <p>Close unused optical sockets and plugs as well as pluggable transceivers and slots with the supplied protective caps.</p> <p>Remove the protective caps only immediately before you use the plug-in connection.</p>

### Safety notices on use in hazardous areas

#### General safety notices relating to protection against explosion

 <b>WARNING</b>
<p><b>EXPLOSION HAZARD</b></p> <p>Do not connect or disconnect cables to or from the device when a flammable or combustible atmosphere is present.</p>

**Safety notices when using the device according to Hazardous Locations (HazLoc)**

If you use the device under HazLoc conditions you must also keep to the following safety notices in addition to the general safety notices for protection against explosion:

 <b>WARNING</b>
<b>EXPLOSION HAZARD</b>
DO NOT DISCONNECT WHILE CIRCUIT IS LIVE UNLESS AREA IS KNOWN TO BE NON-HAZARDOUS.

**Safety notices for use according to ATEX and IECEx**

If you use the device under ATEX or IECEx conditions you must also keep to the following safety notices in addition to the general safety notices for protection against explosion:

 <b>WARNING</b>
Take measures to prevent transient voltage surges of more than 40% of the rated voltage. This is the case if you only operate devices with SELV (safety extra-low voltage).

 <b>WARNING</b>
Before connecting up and commissioning the device, read the information in the section Safety instructions (Page 11)

---

**Note**

**Commissioning devices with redundancy mechanisms**

If you use redundancy mechanisms ("HRP" media redundancy or "MRP" and/or redundant coupling of rings over standby coupling), open the redundant path before you insert a new or replacement device in an operational network. A bad configuration or attachment of the Ethernet cables to incorrectly configured ports causes overload in the network and a breakdown in communication.

A device may only be inserted in a network and connected in the following situations:

- **HRP/MRP:**  
The ring ports of the device being inserted in the ring were configured as ring ports. The required redundancy mode must also be enabled (see "Configuration Manual SCALANCE X-300 / X-400", section "X-300 Ring Configuration"). If the device is intended to operate as the redundancy manager, "Redundancy manager enabled" must also be set.
- **Standby coupling:**  
"Standby connection" must be "enabled" and the "Standby connection name" must match the name of the partner device. You will also need to configure the port with "Enable Standby Port Monitoring" (see "Configuration Manual SCALANCE X-300 / X-400", section "X-300/X-400 Standby Mask").

## 5.2 Wiring rules

When wiring use cables with the following AWG categories or cross sections.

Wiring rules for ...		Screw-type terminals/Spring-loaded terminals
connectable cable cross sections for flexible cables ...	without wire end ferrule	0.2 - 2.5 mm <sup>2</sup> AWG: 24 - 13
	with wire end ferrule with plastic ferrule**	0.25 - 2.5 mm <sup>2</sup> AWG: 24 - 13
	with wire end ferrule without plastic ferrule**	0.25 - 2.5 mm <sup>2</sup> AWG: 24 - 13
	with TWIN wire end ferrule**	0.5 - 1 mm <sup>2</sup> AWG: 20 - 17
Stripped length of the cable		8 - 10 mm
Wire end ferrule according to DIN 46228 with plastic ferrule**		8 - 10 mm

\* AWG: American Wire Gauge

\*\* See note "Wire end ferrules"

### Note

#### Wire end ferrules

Use crimp shapes with smooth surfaces, such as provided by square and trapeze shaped crimp cross sections.

Crimp shapes with wave-shaped profile are unsuitable.

## 5.3 Connecting the switch

### Procedure for connecting the device

Follow the steps below to connect the device:

1. Turn off the power supply.
2. Connect the grounding of the switch according to the following description.
3. Connect the signaling contact of the switch according to the following description.
4. Connect the power supply of the switch according to the following description.
5. Connect the network nodes / subnets to the switch.
6. Turn on the power supply for the switch.

## 5.4 Connecting functional ground

### Installation on a DIN rail

The device is grounded over the DIN rail.

### S7 standard rail

The device is grounded over its rear panel and the neck of the screw.

### Wall mounting

The device is grounded by the securing screw in the unpainted hole.

Please note that IE Switches X-300 must be grounded over one securing screw with minimum resistance.

If an IE Switch X-300 is mounted on a non-conducting base, a grounding cable must be installed. The grounding cable is not supplied with the device. Connect the paint-free surface of the IE Switch X-300 to the nearest grounding point using the grounding cable.

### 19" rack mounting





- 24 VDC variant:  
Grounding is via the mounting bracket on the device or alternatively/additionally via the screw-on bolts on the rear of the device.
- 100 to 240 VAC variant:  
Grounding is via the mounting bracket on the device or alternatively/additionally via the screw-on bolts on the rear of the device.

## 5.5 24 VDC signaling contact

The signaling contact is connected to a 2-pin plug-in terminal block.

The signaling contact can be subjected to a maximum load of 100 mA (safety extra low voltage SELV 12 VDC / 24 VDC).

Table 5- 1 Pin assignment of the signaling contact

Pin number	Assignment (example)
<div style="display: flex; align-items: center;"> <div style="margin-right: 10px;">1</div>  <div style="margin-right: 10px;">2</div>   </div>	
Pin 1	F1
Pin 2	F2

## 5.6 Power supply

### 5.6.1 24 VDC - product group X-300

Table 5- 2 24 to 48 VDC safety extra-low voltage overview

Device	Device version (power supply)	24 V safety extra-low voltage (SELV)
		can be connected redundantly
X304-2FE	1 x 24 VDC	•
X306-1LD FE	1 x 24 VDC	•
X307-3	1 x 24 VDC	•
X307-3LD	1 x 24 VDC	•
X308-2	1 x 24 VDC	•
X308-2LD	1 x 24 VDC	•
X308-2LH	1 x 24 VDC	•
X308-2LH+	1 x 24 VDC	•
X310	1 x 24 VDC	•
X310FE	1 x 24 VDC	•
X320-1 FE	1 x 24 VDC	•
X320-3LD FE	1 x 24 VDC	•

### 5.6.2 Power supply

 <b>WARNING</b>
<p><b>Operation only with safety extra-low voltage</b></p> <ul style="list-style-type: none"> <li>• The IE Switch X-300 is designed for operation with safety extra-low voltage (SELV). This means that only safety extra-low voltages (SELV) complying with IEC950/EN60950/ VDE0805 can be connected to the power supply terminals.</li> <li>• The power supply unit for the IE Switch X-300 power supply must meet NEC Class 2, as described by the National Electrical Code(r) (ANSI/NFPA 70).</li> <li>• The power of all connected power supply units must total the equivalent of a power source with limited power (LPS limited power source).</li> <li>• If the device is connected to a redundant power supply (two separate power supplies), both must meet these requirements.</li> <li>• The signaling contact can be subjected to a maximum load of 100 mA (safety extra-low voltage (SELV), 24 V DC).</li> <li>• Never operate the device with AC voltage or DC voltage higher than 32 V DC.</li> </ul>



<p><b>NOTICE</b></p> <p><b>Damage to the device due to overvoltage</b></p> <p>If IE Switches X-300 are supplied over long 24 V power supply lines or networks, measures are necessary to prevent interference by strong electromagnetic pulses on the supply lines. These can result, for example, due to lightning or switching of large inductive loads.</p> <p>One of the tests used to attest the immunity of devices of the IE Switches X-300 to electromagnetic interference was the "surge immunity test" according to EN61000-4-5. This test requires overvoltage protection for the power supply lines. A suitable device is, for example, the Dehn Blitzductor BVT AVD 24V article no. 918 422 or comparable protective element.</p> <p>Manufacturer: DEHN+SÖHNE GmbH+Co.KG, Postfach 1640, D-92306 Neumarkt, Germany.</p>
--

### Connecting 24 V safety extra-low voltage (SELV)

- The power supply is connected using a 4-pin plug-in terminal block.
- The power supply can be connected redundantly. Both inputs are isolated. There is no distribution of load. When a redundant power supply is used, the power supply unit with the higher output voltage supplies the IE Switch X-300 alone.
- The power supply is connected over a high resistance with the enclosure to allow an ungrounded set up. The two power inputs are non-floating.

Table 5- 3 Pin assignment for the power supply

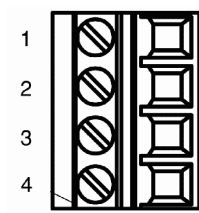
Pin number	Assignment (terminal block)
	
<b>Pin 1</b>	L1+ (24 VDC)
<b>Pin 2</b>	M1
<b>Pin 3</b>	M2
<b>Pin 4</b>	L2+ (24 VDC)



## Technical data

---

### Note

#### Validity of the technical specifications

All the technical specifications described in this section that is not assigned to a specific device variant, version or a media module, apply to all device variants/versions of the product group.

---

## 6.1 Construction, installation and environmental conditions

Table 6- 1 Construction

Device variant	Dimensions (W x H x D)	Weight	Degree of protection
X304-2FE, X306-1LD FE	60 × 125 × 123 mm	700 g	IP30
X307-3, X307-3LD, X308-2, X308-2LD, X308-2LH, X308-2LH+, X310, X310FE,	120 × 125 × 123 mm	1400 g	IP30
X320-1FE, X320-3LD FE	180 × 125 × 123 mm	1650 g	IP30

6.1 Construction, installation and environmental conditions

Table 6- 2 Installation options

Device variant	Installation options
X304-2FE, X306-1LD FE	<ul style="list-style-type: none"> <li>• DIN rail</li> <li>• S7-300 standard rail</li> <li>• Wall</li> </ul>
X307-3, X307-3LD, X308-2, X308-2LD, X308-2LH, X308-2LH+, X310, X310FE, X320-1FE, X320-3LD FE	<ul style="list-style-type: none"> <li>• DIN rail <sup>1)</sup></li> <li>• S7-300 standard rail</li> <li>• Wall</li> </ul>

1) Note: When used in shipbuilding, installation on a 35 mm DIN rail is not permitted. In ships, the 35 mm DIN rail does not provide adequate support.

Table 6- 3 Permitted ambient conditions

Device variant	Storage/transport temperature	Operating temperature	Max. relative humidity in operation at 25 °C	Max. ambient temperature at operating altitude
X304-2FE, X306-1LD FE, X320-1FE, X320-3LD FE	-40 °C to +70 °C	As of hardware product version 1: -40 °C to +60 °C	<= 95% (no condensation)	Max. 55 °C as of 2000 m Max. 50 °C as of 3000 m
X307-3, X308-2	-40 °C to +70 °C	For hardware product version 1: 0 °C to +60 °C As of hardware product version 2: -10 °C to +60 °C	<= 95% (no condensation)	Max. 55 °C as of 2000 m Max. 50 °C as of 3000 m
X307-3LD, X308-2LD, X308-2LH, X308-2LH+, X310, X310FE	-40 °C to +70 °C	For hardware product version 1: 0 °C to +60 °C As of hardware product version 2: -40 °C to +60 °C	<= 95% (no condensation)	Max. 55 °C as of 2000 m Max. 50 °C as of 3000 m

## 6.2 Connectors and electrical data

Table 6- 4 Connection for end devices or network components

Device variant	Electrical over twisted pair	Optical over fiber-optic cable
X304-2FE	4 x RJ-45 jacks with MDI-X assignment 10/100 Mbps (half / full duplex)	2 x SC duplex socket (MM) (100 Mbps, full duplex to 100BaseFX)
X306-1LD FE	6 x RJ-45 jacks with MDI-X assignment 10/100 Mbps (half / full duplex)	1 x SC duplex socket (SM) (100 Mbps, full duplex to 100BaseFX)
X307-3	7 x RJ-45 jacks with MDI-X assignment 10/100 Mbps (half / full duplex)	3 x SC duplex sockets (1000 Mbps, full duplex to 1000BaseSX)
X307-3LD	7 x RJ-45 jacks with MDI-X assignment 10/100 Mbps (half / full duplex)	3 x SC duplex sockets (1000 Mbps, full duplex to 1000BaseLX)
X308-2	7 x RJ-45 jacks with MDI-X assignment 10/100 Mbps (half / full duplex) 1 x RJ-45 socket with MDI-X pinning 10/100/1000 Mbps (half/ full duplex)	2 x SC duplex sockets (1000 Mbps, full duplex to 1000BaseSX)
X308-2LD	7 x RJ-45 jacks with MDI-X assignment 10/100 Mbps (half / full duplex) 1 x RJ-45 jacks with MDI-X assignment 10/100/1000 Mbps (half / full duplex)	2 x SC duplex sockets (1000 Mbps, full duplex to 1000BaseLX)
X308-2LH	7 x RJ-45 jacks with MDI-X assignment 10/100 Mbps (half / full duplex) 1 x RJ-45 socket with MDI-X pinning 10/100/1000 Mbps (half/ full duplex)	2 x SC duplex sockets (1000 Mbps, full duplex to 1000BaseLX)
X308-2LH+	7 x RJ-45 jacks with MDI-X assignment 10/100 Mbps (half / full duplex) 1 x RJ-45 jacks with MDI-X assignment 10/100/1000 Mbps (half / full duplex)	2 x SC duplex sockets (1000 Mbps, full duplex to 1000BaseLX)
X310	7 x RJ-45 jacks with MDI-X assignment 10/100 Mbps (half / full duplex) 3 x RJ-45 jacks with MDI-X assignment 10/100/1000 Mbps (half / full duplex)	-
X310FE	10 x RJ-45 jacks with MDI-X assignment 10/100 Mbps (half / full duplex)	-
X320-1 FE	20 x RJ-45 jacks with MDI-X assignment 10/100 Mbps (half / full duplex)	1 x SC duplex socket (MM) (100 Mbps, full duplex to 100BaseFX)
X320-3LD FE	20 x RJ-45 jacks with MDI-X assignment 10/100 Mbps (half / full duplex)	1 x SC duplex socket (MM) 2 x SC duplex sockets (SM) (100 Mbps, full duplex to 100BaseFX)

6.2 Connectors and electrical data

Table 6- 5 Electrical data: Power supply

Rated voltage Safety extra-low voltage (SELV)	Voltage range	Permitted voltage range including total ripple
24 VDC	19.2 VDC - 28.8 VDC	18 VDC - 32 VDC

Table 6- 6 Electrical data: Power consumption

Device variant	Power loss at 24 VDC	Current consumption at rated voltage 24 VDC	Overcurrent protection at input (non- replaceable fuse)
X304-2FE	6.2 W	260 mA	3 A / 32 V
X306-1LD FE	4.8 W	200 mA	3 A / 32 V
X307-3, X307-3LD, X308-2, X308-2LD, X308-2LH, X308-2LH+, X310, X310FE, X320-1 FE	9.6 W	400 mA	3 A / 32 V
X320-3LD FE	12 W	500 mA	3 A / 32 V

Table 6- 7 Electrical data: Signaling contact

Voltage via signaling contact	24 VDC
Switching capacity (resistive load)	max. 100 mA

Table 6- 8 Plug-in terminal block for connectors of the power supply and signaling contact

Power supply	1 x 4-pin
Signaling contact	1 x 2-pin

Table 6- 9 Electrical data: Transmitter output (optical) and receiver input

Device variant	Transmitter output (optical)		Receiver input	
	min. [dBm]	max. [dBm]	Sensitivity min. [dBm]	Input power max. [dBm]
X304-2FE	-19	-14	-32	-3
X306-1LD FE	-15	-8	-34	-3

Device variant	Transmitter output (optical)		Receiver input	
	min. [dBm]	max. [dBm]	Sensitivity min. [dBm]	Input power max. [dBm]
X307-3	-9.5	-4	-17	-3
X307-3LD	-9.5	-3	-21	-3
X308-2	-9.5	-4	-17	-3
X308-2LD	-9.5	-3	-21	-3
X308-2LH	-6	0	-23	-3
X308-2LH+	0	5	-23	-3
X310	-	-	-	-
X310FE	-	-	-	-
X320-1 FE	-19	-14	-32	-3
X320-3LD FE	-15 <sup>1)</sup>	-8 <sup>1)</sup>	-34 <sup>1)</sup>	-3 <sup>1)</sup>
	-19 <sup>2)</sup>	-14 <sup>2)</sup>	-32 <sup>2)</sup>	-3 <sup>2)</sup>

1) Fast Ethernet, long distance interface

2) Fast Ethernet, multimode interface

---

**Note**

**Exception in the naming of X320-3LD FE**

With the X320-3LD FE IE switch, the key to the name is different. The position -3LD covers a total of 3 connectors (1-2) of which only 2 connectors are LD, refer to the explanation below:

- Port 21: Multimode
  - Port 22: LD (long distance, single mode)
  - Port 23: LD (long distance, single mode)
- 

---

**Note**

**2 optical interface transceivers possible (X320-3LD FE)**

The device is also equipped with 2 optical interface transceivers.

- 1) Fast Ethernet, long distance interface
- 2) Fast Ethernet, multimode interface

As a result, the electrical data in the technical specifications is divided into two parts: transmitter output optical and receiver input.

---

## 6.3 Cable lengths

Table 6- 10 Permitted cable lengths (copper cable - Fast Ethernet)

Cable type	Accessory (plug, outlet, TP cord)	Permitted cable length
IE TP torsion cable	with IE FC Outlet RJ-45 + 10 m TP cord	0 to 45 m + 10 m TP cord
	with IE FC RJ-45 Plug 180	0 to 55 m
IE FC TP Marine Cable IE FC TP Trailing Cable IE FC TP Flexible Cable	with IE FC Outlet RJ-45 + 10 m TP cord	0 to 75 m + 10 m TP cord
	with IE FC RJ-45 Plug 180	0 to 85 m
IE FC TP standard cable	with IE FC Outlet RJ-45 + 10 m TP cord	0 to 90 m + 10 m TP cord
	with IE FC RJ-45 Plug 180	0 to 100 m

Table 6- 11 Permitted cable lengths (copper cable - gigabit Ethernet)

Cable type	Accessory (plug, outlet, TP cord)	Permitted cable length
IE FC standard cable, 4×2, 24 AWG IE FC flexible cable, 4×2, 24 AWG	with IE FC RJ-45 Plug 180, 4x2	0 to 90 m
IE FC standard cable, 4×2, 22 AWG	with IE FC Outlet RJ-45 + 10 m TP cord	0 to 60 m + 10 m TP cord
IE FC flexible cable, 4×2, 22 AWG	with IE FC Outlet RJ-45 + 10 m TP cord	0 to 90 m + 10 m TP cord

Table 6- 12 Permitted cable lengths (fiber-optic cable - Fast Ethernet)

Device variant	Fiber-optic cable type	Permitted cable length	Attenuation
X304-2FE, X320-1 FE	50/125 µm multimode fiber	0 to 5 km	≤1 dB/km at 1310 nm; 1200 MHz×km; maximum insertion loss 0.5 dB; 9 dB max. permitted FO cable attenuation at 3 dB link power margin
	62.5/125 µm multi-mode fiber	0 ... 5 km	≤1 dB/km at 1310 nm; 1200 MHz×km; maximum insertion loss 0.5 dB; 9 dB max. permitted FO cable attenuation at 3 dB link power margin
X306-1LD FE	9/125 µm single mode fiber	0 to 26 km	≤0.5 dB/km at 1310 nm; maximum insertion loss 0.5 dB; 14 dB max. permitted FO cable attenuation at 2 dB link power margin



Device variant	Fiber-optic cable type	Permitted cable length	Attenuation
X310FE	-	-	-
X320-3LD FE	50/125 µm multimode fiber	0 to 5 km	≤1 dB/km at 1310 nm; 1200 MHz×km; maximum insertion loss 0.5 dB; 9 dB max. permitted FO cable attenuation at 3 dB link power margin
	9/125 µm single mode fiber	0 to 26 km	≤0.5 dB/km at 1310 nm; maximum insertion loss 0.5 dB; 14 dB max. permitted FO cable attenuation at 2 dB link power margin

Table 6- 13 Permitted cable lengths (fiber-optic cable - gigabit)

Device variant	Fiber-optic cable type	Permitted cable length	Attenuation
X307-3, X308-2	62.5/125 µm multimode fiber	0 to 350 m	≤3.1 dB/km at 850 nm; 1200 MHz×km; maximum insertion loss 0.5 dB; 4.5 dB max. permitted FO cable attenuation at 3 dB link power margin
	50/125 µm multimode fiber	0 to 750 m	≤2.5 dB/km at 850 nm; 1200 MHz×km; maximum insertion loss 0.5 dB; 4.5 dB max. permitted FO cable attenuation at 3 dB link power margin
X307-3LD X308-2LD	9/125 µm single mode fiber	0 to 10 km	≤0.5 dB/km at 1310 nm; maximum insertion loss 0.5 dB; 6 dB max. permitted FO cable attenuation at 3 dB link power margin
X308-2LH	9/125 µm single mode fiber	... 40 km	≤0.4 dB/km at 1550 nm; maximum insertion loss 0.5 dB; 18 dB max. permitted FO cable attenuation at 2 dB link power margin; minimum cable attenuation 3 dB
X308-2LH+	9/125 µm single mode fiber	... 70 km	≤0.28 dB/km at 1550 nm; maximum insertion loss 0.5 dB; 21 dB max. permitted FO cable attenuation at 2 dB link power margin; minimum cable attenuation 8 dB
X310	-	-	-

## 6.4 Other properties

Table 6- 14 Switching properties

Max. number of learnable addresses	8000
Aging time	30 sec
Switching technique	Store and forward
Latency	5 µs

Table 6- 15 Reconfiguration times for redundancy mechanisms

Redundancy mechanism	Reconfiguration times
HRP	300 ms
Standby link	300 ms
MRP	200 ms

Table 6- 16 Mean time between failure (MTBF)

Device variant	MTBF <sup>1)</sup>
X304-2FE	55 years
X306-1LD FE	65 years
X307-3	40 years
X308-2	42 years
X307-3LD , X308-2LD, X308-2LH, X308-2LH+,	38 years
X310, X310FE	45 years
X320-1 FE	35 years
X320-3LD FE	30 years

<sup>1)</sup> These values apply at 40 °C.

**Note**

The IE Switches X-300 support "full wire speed switching" complying with IEEE 802.3 on all ports. The number of packets therefore depends on the packet length.

Table 6- 17 Full wire speed switching

Number of frames per second		At a frame length of
At 100 Mbps	At 1000 Mbps	
148810	1488095	64 bytes
84459	844595	128 bytes
45290	452899	256 bytes
23496	234962	512 bytes
11973	119732	1024 bytes
9615	96154	1280 bytes
8127	81274	1518 bytes

---

**Note**

The following applies to IE Switches X-300:

The number of IE Switches X-300 connected in a line influences the frame delay time. When a frame passes through the switch, this is delayed by the Store&Forward function of the IE Switch X-300 by the following values:

- at 64 bytes frame length: Delay of approx. 10 microseconds (at 100 Mbps)
- at 1500 bytes frame length: Delay of approx. 130 microseconds (at 100 Mbps)

This means, the more IE Switches X-300 a frame runs through, the higher the frame delay.

---



## Dimension drawings

### 7.1 Dimension drawing

**Note**

The IE Switches X-300 are available in small, medium and large variants. The dimension drawings are shown below.

#### Small design

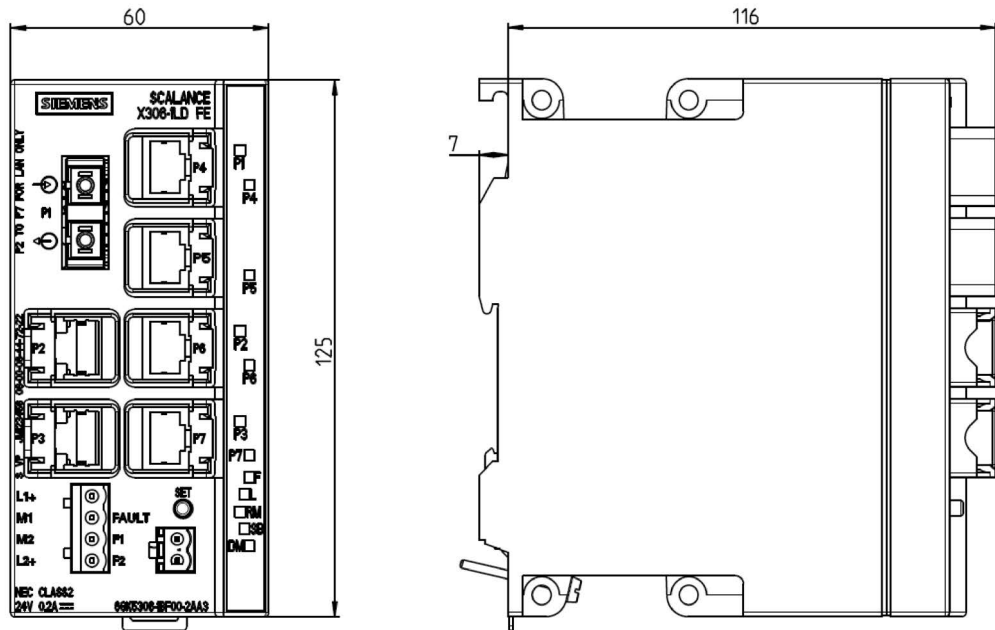

Image 7-1 Small design dimension drawing (example used here SCALANCE X306-1LD FE)

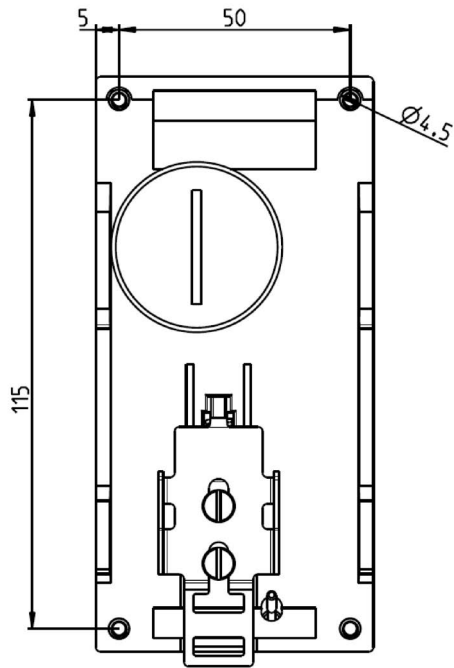

Image 7-2 Small design dimension drawing (IE Switch X-306)

### Medium design

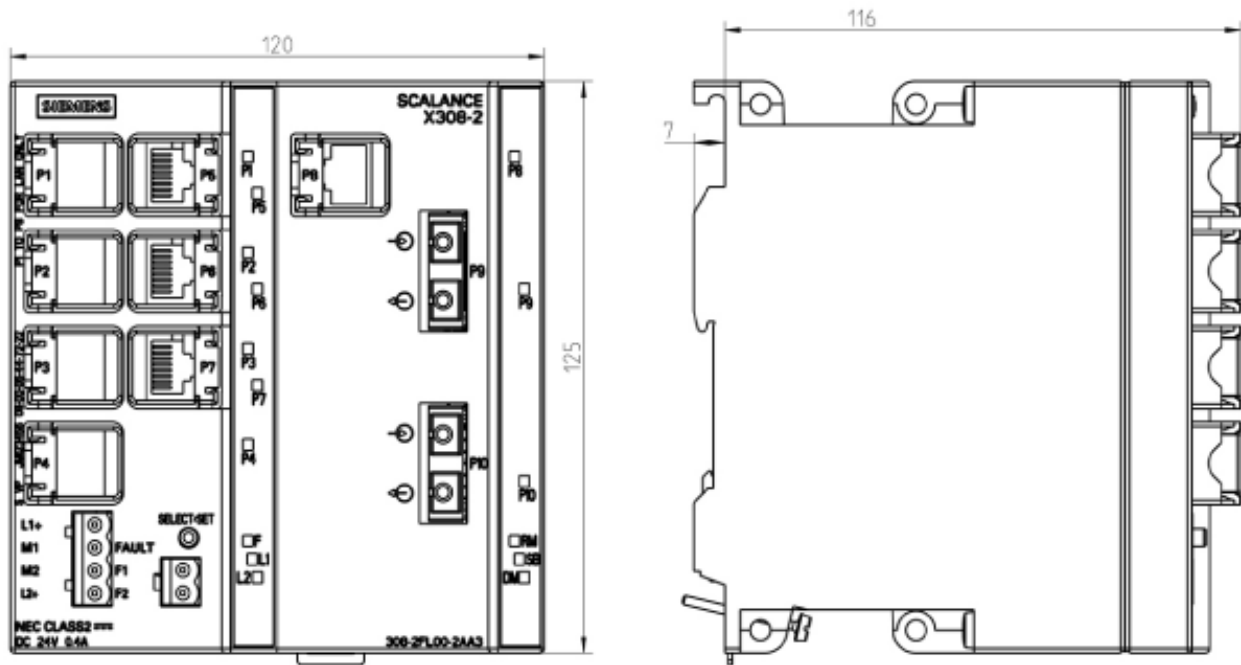

Image 7-3 Medium design dimension drawing (example used here SCALANCE X308-2)

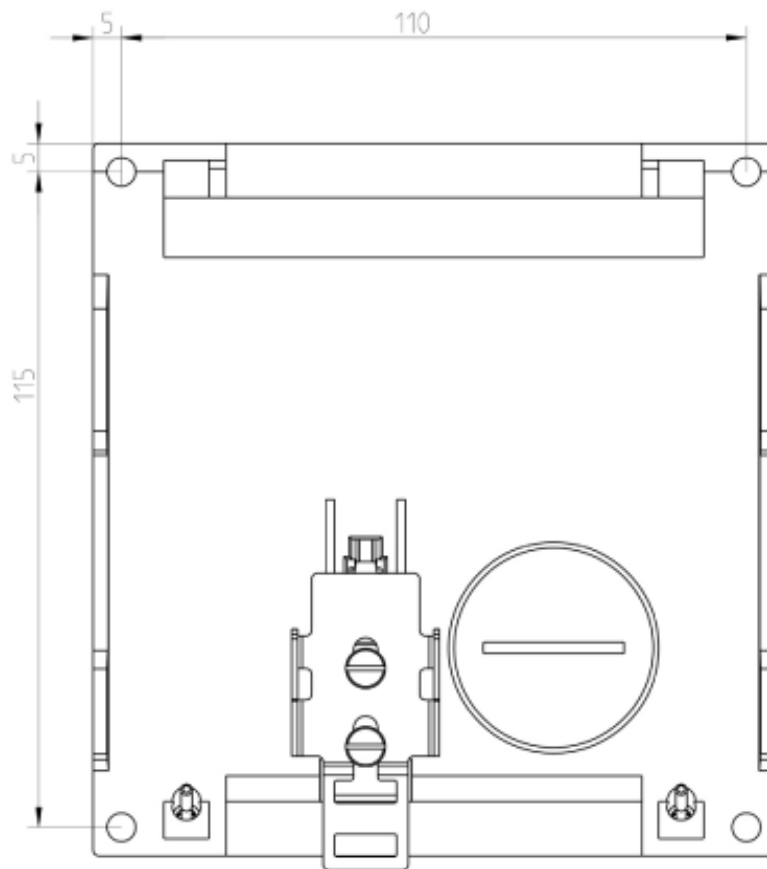

Image 7-4 Medium design dimension drawing (IE Switch X-300)





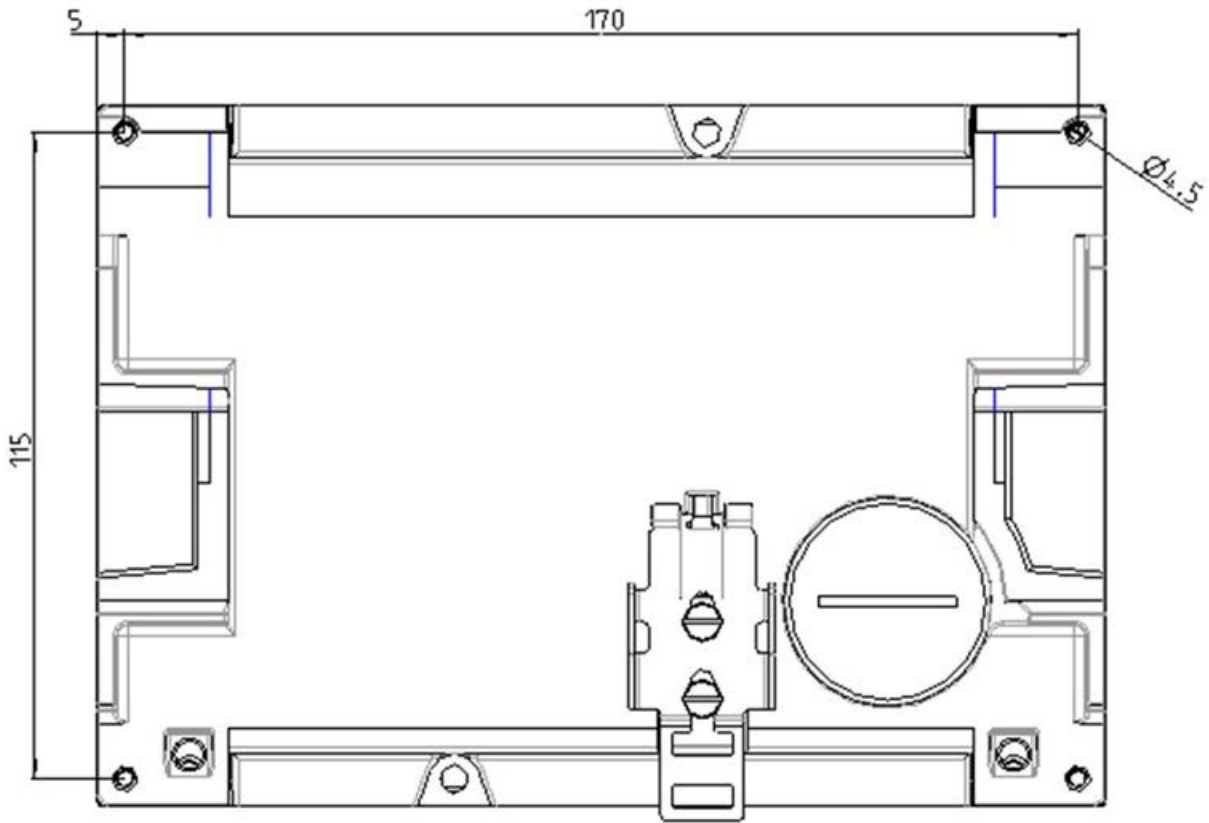

Image 7-7 Large design dimension drawing (IE Switch X-320)

# Certifications and approvals

## 8.1 X-300 approvals, certificates

### Approvals issued

---

#### Note

#### Issued approvals on the type plate of the device

The specified approvals apply only when the corresponding mark is printed on the product. You can check which of the following approvals have been granted for your product by the markings on the type plate.

---

### EC directives

SIMATIC NET products meet the requirements and aims of the following EC directives.

### EMC directive (electromagnetic compatibility)

The SIMATIC NET products described in these operating instructions meet the requirements of EC directive 2004/108/EC "Electromagnetic Compatibility" for the following areas of application:

Field of application	Requirements	
	Emission	Immunity to interference
Industry	EN 61000-6-4 : 2007	EN 61000-6-2 : 2005

<p> <b>WARNING</b></p> <p><b>Personal injury and property damage can occur</b></p> <p>The installation of expansions that are not approved for SIMATIC NET products or their target systems may violate the requirements and regulations for safety and electromagnetic compatibility.</p> <p>Only use expansions that are approved for the system.</p>
--

- **Keep to the installation guidelines**  
The devices meet the requirements if you adhere to the installation and safety instructions contained in this documentation and in the following documentation when installing and operating the devices.
- **You can always find the latest documentation on the Internet**  
The current descriptions of the currently available products can always be found on the Internet under the specified entry IDs/Internet pages:
  - "Industrial Ethernet / PROFINET Industrial Ethernet" System Manual
  - "Industrial Ethernet / PROFINET - Passive network components" System Manual  
You will find information on the system manuals in the section "ID = 27069465 (<http://support.automation.siemens.com/WW/view/en/27069465>)", in "Further documentation".
  - "EMC Installation Guidelines" configuration manual  
ID = 60612658 (<http://support.automation.siemens.com/WW/view/en/60612658>)
- **Working on the device**  
To protect the device from electrostatic discharge, personnel must first discharge any electrostatic charge from their body before touching the device.

---

**Note**

The test was performed with a device and a connected communications partner that also meets the requirements of the standards listed above.

When operating the device with a communications partner that does not comply with these standards, adherence to the corresponding values cannot be guaranteed.

---

## Machinery directive

The product is a component in compliance with the EC Machinery Directive 2006/42/EEC. According to the machinery directive, we are obliged to point out that the product described is intended solely for installation in a machine.

Before the final product can be put into operation, it must be tested to ensure that it conforms with the directive 2006/42/EEC.

---

**Note**

**Note for the manufacturers of machines**

This product is not a machine in the sense of the EC Machinery Directive. There is therefore no declaration of conformity relating to the EC Machinery Directive 2006/42/EEC for this product.

---

## Note for the manufacturers of machines

This product is not a machine in the sense of the EC Machinery Directive. There is therefore no declaration of conformity relating to the EC Machinery Directive 89/392/EEC for this product.

## ATEX (explosion protection directive)

 <b>WARNING</b>
When using SIMATIC NET products in hazardous area zone 2, make absolutely sure that the associated conditions in the following document are adhered to: "SIMATIC NET Product Information Use of subassemblies/modules in a Zone 2 Hazardous Area". You will find this document <ul style="list-style-type: none"><li>• on the data medium that ships with some devices.</li><li>• on the Internet pages of Siemens Industry Online Support (<a href="http://support.automation.siemens.com/WW/view/en">http://support.automation.siemens.com/WW/view/en</a>).</li></ul> Enter the document identification number C234 as the search term.

SIMATIC NET products meet the requirements of the EC directive:94/9/EC "Equipment and Protective Devices for Use in Potentially Explosive Atmospheres".

ATEX classification:

II 3 G Ex nA IIC T4 Gc

KEMA 07ATEX0145 X

The products meet the requirements of the following standards:

- EN 60079-15: 2010 (electrical apparatus for potentially explosive atmospheres; Type of protection "n")
- EN 60079-0: 2009 (Explosive atmospheres - Part 0: Equipment - General requirements)

## IECEX

The SIMATIC NET products meet the requirements of explosion protection according to IECEX.

IECEX classification:

Ex nA IIC T4 Gc

DEK 14.0025X

The products meet the requirements of the following standards:

- IEC 60079-15 : 2010 (Explosive atmospheres - Part 15: Equipment protection by type of protection "n")
- IEC 60079-0 : 2011 (Explosive atmospheres - Part 0: Equipment - General requirements)

## FM

The product meets the requirements of the standards:

- Factory Mutual Approval Standard Class Number 3611
- FM Hazardous (Classified) Location Electrical Equipment:  
Non Incendive / Class I / Division 2 / Groups A,B,C,D / T4 and  
Non Incendive / Class I / Zone 2 / Group IIC / T4

## C-Tick

The product meets the requirements of the AS/NZS 2064 standard (Class A).

## cULus Approval for Information Technology Equipment

cULus Listed I. T. E.

Underwriters Laboratories Inc. complying with

- UL 60950-1 (Information Technology Equipment)
- CSA C22.2 No. 60950-1-03

Report no. E115352

## cULus approval for industrial control equipment

cULus Listed IND. CONT. EQ.

Underwriters Laboratories Inc. complying with

- UL 508
- CSA C22.2 No. 142-M1987

Report no. E85972

## cULus Approval Hazardous Location

cULus Listed I. T. E. FOR HAZ. LOC.

Underwriters Laboratories Inc. complying with

- UL 60950-1 (Information Technology Equipment)
- ANSI/ISA 12.12.01-2007
- CSA C22.2 No. 213-M1987

Approved for use in

Cl. 1, Div. 2, GP A, B, C, D T4

Cl. 1, Zone 2, GP IIC T4

Report no. E240480

## 8.2 SCALANCE X-300 declaration of conformity

You will find the EC Declaration of Conformity for these products on the Internet at the following address:

SCALANCE X-300 declaration of conformity

(<https://support.industry.siemens.com/cs/ww/en/ps/15296/cert>)

1. Click on the entry "SCALANCE X-300 managed" in the navigation panel at the top edge of the window and from the drop-down list that opens, select the entry for your product group.
2. Select the entry "Certificate" from the "Entry type" drop-down list.

Result: A list of the available certificates is displayed.

## 8.3 X-300 FDA and IEC approvals

The following devices meet the FDA and IEC requirements listed below:

Type	Fulfills FDA and IEC requirements
X304-2FE	CLASS 1 LED Product
X306-1LD FE	CLASS 1 LASER Product
X307-3	CLASS 1 LASER Product
X307-3LD	CLASS 1 LASER Product
X308-2	CLASS 1 LASER Product
X308-2LD	CLASS 1 LASER Product
X308-2LH	CLASS 1 LASER Product
X308-2LH+	CLASS 1 LASER Product
X310	-
X310FE	-
X320-1FE	CLASS 1 LED Product
X320-3LD FE	CLASS 1 LASER Product



Image 8-1 FDA and IEC approvals

## 8.4 Overview of the X-300 approvals

Table 8- 1 Overview of the approvals

Type	c-UL-us	c-UL-us for hazardous locations <sup>1</sup>	FM <sup>1</sup>	C-TICK	CE	ATEX95 Zone 2 <sup>1</sup>	E1
X304-2FE	•	•	•	•	•	•	-
X306-1LD FE	•	•	•	•	•	•	-
X307-3	•	•	•	•	•	•	-
X307-3LD	•	•	•	•	•	•	-
X308-2	•	•	•	•	•	•	-
X308-2LD	•	•	•	•	•	•	-
X308-2LH	•	•	•	•	•	•	-
X308-2LH+	•	•	•	•	•	•	-
X310	•	•	•	•	•	•	-
X310FE	•	•	•	•	•	•	-
X320-1FE	•	•	•	•	•	•	-
X320-3LD FE	•	•	•	•	•	•	-

<sup>1</sup>For temperature information "T.." or the maximum ambient temperature "Ta:..", refer to the type plate.

**Note**

**Shipbuilding approval**

No applications for shipbuilding approvals will be made for the SCALANCE X-300.

## 8.5 X-300 mechanical stability (in operation)

Type	IEC 60068-2-6 vibration	IEC 60068-2-27 shock
	5 – 9 Hz: 3.5 mm 9 – 150 Hz: 1 g 1 octave/min, 20 sweeps	15 g, 11 ms duration 6 shocks per axis
X304-2FE	•	•
X306-1LD FE	•	•
X307-3	•	•
X307-3LD	•	•
X308-2	•	•
X308-2LD	•	•
X308-2LH	•	•
X308-2LH+	•	•
X310	•	•
X310FE	•	•



*8.5 X-300 mechanical stability (in operation)*

<b>Type</b>	<b>IEC 60068-2-6 vibration</b>	<b>IEC 60068-2-27 shock</b>
X320-1FE	5 – 9 Hz: 3.5 mm 9 – 150 Hz: 1 g 1 octave/min, 20 sweeps	15 g, 11 ms duration 6 shocks per axis
X320-3LD FE	•	•



# Index

## G

Glossary, 6

## H

Hazardous area, 12

## P

Possible attachments

- SCALANCE 307-3LD, 19
- SCALANCE 308-2LH+, 23
- SCALANCE X306-1LD FE, 17
- SCALANCE X307-3, 18
- SCALANCE X308-2, 20
- SCALANCE X308-2LD, 21
- SCALANCE X308-2LH, 22
- SCALANCE X310, 24
- SCALANCE X310FE, 25
- SCALANCE X320-1 FE, 26
- X320-3LD FE, 27

## S

Safety notices, 12

- for installation, 35
- general, 11
- Use in hazardous areas, 11, 35, 43
- when connecting up, 43

SIMATIC NET glossary, 6

System manual, 68

