

SIEMENS

SIMATIC NET

Industrial Ethernet switches SCALANCE XR-300M PoE

Compact Operating Instructions

<u>Introduction</u>	1
<u>Safety instructions</u>	2
<u>Description</u>	3
<u>Installation</u>	4
<u>Connecting up</u>	5
<u>Technical specifications</u>	6
<u>Dimension drawings</u>	7
<u>Approvals</u>	8
<u>Appendix</u>	A

Legal information

Warning notice system

This manual contains notices you have to observe in order to ensure your personal safety, as well as to prevent damage to property. The notices referring to your personal safety are highlighted in the manual by a safety alert symbol, notices referring only to property damage have no safety alert symbol. These notices shown below are graded according to the degree of danger.

DANGER

indicates that death or severe personal injury **will** result if proper precautions are not taken.

WARNING

indicates that death or severe personal injury **may** result if proper precautions are not taken.

CAUTION

indicates that minor personal injury can result if proper precautions are not taken.

NOTICE

indicates that property damage can result if proper precautions are not taken.

If more than one degree of danger is present, the warning notice representing the highest degree of danger will be used. A notice warning of injury to persons with a safety alert symbol may also include a warning relating to property damage.

Qualified Personnel

The product/system described in this documentation may be operated only by **personnel qualified** for the specific task in accordance with the relevant documentation, in particular its warning notices and safety instructions. Qualified personnel are those who, based on their training and experience, are capable of identifying risks and avoiding potential hazards when working with these products/systems.

Proper use of Siemens products

Note the following:

WARNING

Siemens products may only be used for the applications described in the catalog and in the relevant technical documentation. If products and components from other manufacturers are used, these must be recommended or approved by Siemens. Proper transport, storage, installation, assembly, commissioning, operation and maintenance are required to ensure that the products operate safely and without any problems. The permissible ambient conditions must be complied with. The information in the relevant documentation must be observed.

Trademarks

All names identified by ® are registered trademarks of Siemens AG. The remaining trademarks in this publication may be trademarks whose use by third parties for their own purposes could violate the rights of the owner.

Disclaimer of Liability

We have reviewed the contents of this publication to ensure consistency with the hardware and software described. Since variance cannot be precluded entirely, we cannot guarantee full consistency. However, the information in this publication is reviewed regularly and any necessary corrections are included in subsequent editions.

Table of contents

1	Introduction	5
1.1	Product group XR-300M PoE	7
1.2	Type designations	8
2	Safety instructions	9
2.1	Important notes on using the product group XR-300M PoE.....	9
2.2	PELV	12
2.3	Important notes on using the device in hazardous areas	12
2.4	Important notices 100 to 240 VAC.....	13
2.5	Safety requirements - Installation 100 to 240 VAC.....	13
3	Description	15
3.1	Unpacking and checking.....	15
3.2	Components of the product XR-300M PoE	15
3.3	Power over Ethernet (PoE).....	16
3.4	Product characteristics.....	17
3.5	The SET / SELECT button.....	18
3.6	LED display	19
3.7	C-PLUG	23
3.7.1	Area of application and function of the C-PLUG.....	23
3.7.2	Removal and insertion of the C-PLUG (rack devices).....	24
4	Installation	27
4.1	Safety notices for installation	27
4.2	Suitable cables for temperatures above 70 °C - cable 50 °C - 70 °C (ATEX).....	28
4.3	Suitable cables for temperatures in excess of 70 °C (ATEX).....	28
4.4	Notes on installation.....	29
4.5	19" rack mounting	30
4.6	Vertical installation of rack devices.....	35
4.7	Desktop operation.....	35
4.8	Installation of modular devices	36
4.8.1	Installation and removal of media modules	36
4.8.2	SFP installation in SFP media module	40
5	Connecting up	43
5.1	Notes on commissioning.....	44

5.2	Connecting functional ground	45
5.3	Signaling contact.....	46
5.3.1	24 V DC signaling contact (XR-300M).....	46
5.4	Diagnostics port	47
5.4.1	Diagnostics port rear	47
5.5	Power supply.....	48
5.5.1	Power supply XR-300M PoE	48
5.5.2	Connecting devices with 24 VDC power supply	49
5.5.2.1	24 VDC - XR-300M PoE product group.....	49
5.5.2.2	Connecting the external 24 VDC power supply	49
5.5.3	Connecting devices with 100 to 240 VAC power supply	51
5.5.3.1	100 to 240 VAC XR-300M PoE product group	51
5.5.3.2	Notes on the power supply 100 to 240 VAC	51
5.5.3.3	Fitting the connector for 100 to 240 V AC.....	52
5.5.3.4	Connecting the 100 to 240 V AC power supply	53
6	Technical specifications	55
6.1	Construction, installation and environmental conditions.....	55
6.2	Connectors and electrical data	57
6.3	Cable lengths	59
6.4	Other properties	61
7	Dimension drawings.....	63
8	Approvals	65
8.1	XR-300M PoE approvals, certificates	65
8.2	SCALANCE X-300 declaration of conformity.....	68
8.3	Overview of XR-300M PoE approvals	69
8.4	Mechanical stability in operation	69
A	Appendix	71
A.1	The connector system M12/X coded according to IEC 61076-2-109	71
	Index	73

Introduction

Purpose of the Operating Instructions (compact)

With the Operating Instructions (compact), you will be able to mount and connect up the SCALANCE XR324-4M PoE and XR324-4M PoE TS correctly. The configuration and the integration of the relevant device in a network are not described in these instructions.

Validity of these Operating Instructions (compact)

These Operating Instructions (compact) apply to the following switches:

- XR324-4M PoE
- XR324-4M PoE TS

Names of the devices in these operating instructions (compact)

Classification	Description	Terms used
Product line	For all devices and variants of all product groups within the SCALANCE X-300 product line, the term IE switches X-300 is used.	IE switches X-300
Product group	For all devices and variants of a product group, only the product group is used.	XR-300M PoE
Device	For a device, only the device name is used.	XR-324-4M PoE
Variant	For a variant of the device, the device name has the appropriate variant added to it in brackets (2x24V).	(-)
All variants of a device	For all variants of the device, the device name has (all) added to it.	(-)

Documentation on the accompanying CD

You will find detailed information on configuration in the configuration manual SCALANCE X300/X400 on the accompanying CD in the file:

PH_SCALANCE-X-300-X-400_76.pdf

Security messages

Note

Siemens offers IT security mechanisms for its automation and drive product portfolio in order to support the safe operation of the plant/machine. Our products are also continuously developed further with regard to IT security. We therefore recommend that you regularly check for updates of our products and that you only use the latest versions. You will find information in:

(<http://support.automation.siemens.com/WW/llisapi.dll?func=cslib.csinfo2&aktprim=99&lang=en>)

Here, you can register for a product-specific newsletter.

For the safe operation of a plant/machine, however, it is also necessary to integrate the automation components into an overall IT security concept for the entire plant/machine, which corresponds to the state-of-the-art IT technology. You will find information on this in:

(<http://www.siemens.com/industrialsecurity>)

Products from other manufacturers that are being used must also be taken into account.

SIMATIC NET glossary

Explanations of many of the specialist terms used in this documentation can be found in the SIMATIC NET glossary.

You will find the SIMATIC NET glossary here:

- SIMATIC NET Manual Collection or product DVD

The DVD ships with certain SIMATIC NET products.

- On the Internet under the following address:

50305045 (<http://support.automation.siemens.com/WW/view/en/50305045>)

1.1 Product group XR-300M PoE

Device	Properties	Order number
XR324-4M PoE	1 x 24 VDC, PoE LEDs, connector power supply and data cable outlet on front Diagnostics port at rear.	6GK5 324-4QG00-1AR2
	1 x 100 to 240 VAC, PoE LEDs, connector power supply and data cable outlet on front Diagnostics port at rear.	6GK5 324-4QG00-3AR2
	1 x 24 VDC, PoE LEDs and diagnostics port at rear, connector power supply and data cable outlet at rear	6GK5 324-4QG00-1HR2
	1 x 100 to 240 VAC, PoE LEDs and diagnostics port on front, connector power supply and data cable outlet at rear	6GK5 324-4QG00-3HR2
XR324-4M PoE TS	1 x 24 VDC, PoE, module varnished LEDs, connector power supply and data cable outlet on front Diagnostics port at rear.	6GK5 324-4QG00-1CR2

Note

For more information on Power over Ethernet (PoE), refer to the Configuration Manual X-300/X-400.

1.2 Type designations

Structure of the type designation

The type designation of an IE Switch X-300 is made up of several parts that have the following meaning:

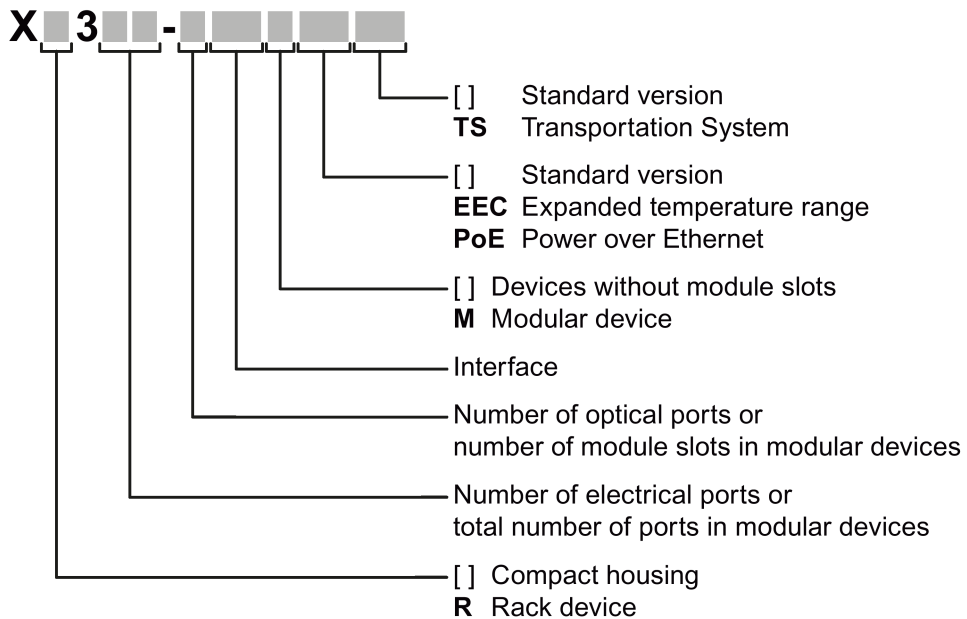

Interfaces of devices without optical ports:

Interface	Property
FE	Electrical RJ-45 port for 10/100 Mbps.
[-]	Electrical RJ-45 port for 10/100 Mbps and 10/100/1000 Mbps.

Interfaces of devices with optical ports:

Interface	Property
FE	SC port 100 Mbps multimode FO cable (up to max. 5 km).
LD FE	SC port 100 Mbps single mode FO cable (up to max. 26 km).
[-]	SC port 1000 Mbps multimode FO cable (up to max. 750 m).
LD	SC port 1000 Mbps single mode FO cable (up to max. 10 km).
LH	SC port 1000 Mbps single mode FO cable (up to max. 40 km).
LH+	SC port 1000 Mbps single mode FO cable (up to max. 70 km).

If information applies to all devices, the term "IE Switches X-300" is used. If information applies to only a particular product group, the relevant names will be used without extra information on the type or number of interfaces. Examples: "X-300" stands for non-modular devices with a compact housing, "XR-300" means all rack devices, "X-300M" means all modular devices etc.

Safety instructions

Read the safety notices

Note the following safety notices. These relate to the entire working life of the device.

You should also read the safety notices relating to handling in the individual sections, particularly in the sections "Installation" and "Connecting up".

Safety notices on use in hazardous areas

General safety notices relating to protection against explosion

 WARNING
EXPLOSION HAZARD
DO NOT OPEN WHEN ENERGIZED.

This equipment is suitable for use in Class I, Division 2, Groups A, B, C and D or non-hazardous locations only.

This equipment is suitable for use in Class I, Zone 2, Group IIC or non-hazardous locations only.

2.1 Important notes on using the product group XR-300M PoE

Safety notices on the use of the devices

The following safety notices must be adhered to when setting up and operating the device and during all associated work such as installation, connecting up, replacing devices or opening the device.

General information

 WARNING
Safety extra low voltage The equipment is designed for operation with Safety Extra-Low Voltage (SELV) by a Limited Power Source (LPS). (This does not apply to 100 V...240 V devices.) This means that only safety extra-low voltage (SELV) and limited power sources (LPS) complying with IEC 60950-1 / EN 60950-1 / VDE 0805-1 must be connected to the power supply terminals or the power supply unit for the equipment power supply must comply with NEC Class 2, as described by the National Electrical Code (r) (ANSI / NFPA 70). If the equipment is connected to a redundant power supply (two separate power supplies), both must meet these requirements. A power source that supplies safety extra low voltage combined with a following NEC Class 2 power limiter also meets the requirements according to IEC 60950-1 / EN 60950-1 / VDE 0805-1 or NEC Class 2. A suitable power limiter is for example the redundancy module SITOP PSE202U NEC Class 2 (article number 6EP1962-2BA00). The maximum current via the 24 V terminals is 8 A. You should therefore include a fuse that trips at a current higher than 8 A. The fuse must meet the following requirements: <ul style="list-style-type: none">• Suitable for DC (min. 60 V / max. 8 A)• Breaking current at least 10 kA• UL/CSA listed (UL 248-1 / CSA 22.2 No.• Classes R, J, L, T or CC As an alternative, the following requirements: <ul style="list-style-type: none">• Suitable for DC (min. 60 V / max. 8 A)• Breaking current at least 10 kA• Approved in compliance with IEC 60127-1 / EN 60127-1• Breaking characteristics: B or C for a circuit breaker or slow-blow fuse

 WARNING
Opening the device DO NOT OPEN WHEN ENERGIZED.

General notices regarding use in hazardous areas

⚠ WARNING**Risk of explosion when connecting or disconnecting the device**

EXPLOSION HAZARD

DO NOT CONNECT OR DISCONNECT EQUIPMENT WHEN A FLAMMABLE OR COMBUSTIBLE ATMOSPHERE IS PRESENT.

⚠ WARNING**Replacing components**

EXPLOSION HAZARD

SUBSTITUTION OF COMPONENTS MAY IMPAIR SUITABILITY FOR CLASS I, DIVISION 2 OR ZONE 2.

⚠ WARNING**Requirements for the cabinet/enclosure**

When used in hazardous environments corresponding to Class I, Division 2 or Class I, Zone 2, the device must be installed in a cabinet or a suitable enclosure.

Notices for use in hazardous areas according to ATEX

⚠ WARNING**Requirements for the cabinet/enclosure**

To comply with EU Directive 94/9 (ATEX95), this enclosure must meet the requirements of at least IP54 in compliance with EN 60529.

⚠ WARNING**Suitable cables for temperatures in excess of 70 °C**

If the cable or conduit entry point exceeds 70 °C or the branching point of conductors exceeds 80 °C, special precautions must be taken. If the equipment is operated in an air ambient in excess of 50 °C up to 70°C, only use cables with admitted maximum operating temperature of at least 80 °C.

⚠ WARNING**Protection against transient voltage surges**

Provisions shall be made to prevent the rated voltage from being exceeded by transient voltage surges of more than 40%. This criterion is fulfilled, if supplies are derived from SELV (Safety Extra-Low Voltage) only.

2.2 PELV

Note

Safety extra-low voltage

The supply of the devices by PELV (Protective Extra Low Voltage) according to DIN VDE 0100-410 or IEC 60364-4-41 is permitted when the generated nominal voltage does not exceed the voltage limits 25 VAC or 60 VDC.

2.3 Important notes on using the device in hazardous areas

 WARNING
--

WARNING - EXPLOSION HAZARD -

DO NOT DISCONNECT WHILE CIRCUIT IS LIVE UNLESS AREA IS KNOWN TO BE NON-HAZARDOUS.

 WARNING
--

Restricted area of application

This equipment is suitable for use in Class I, Division 2, Groups A, B, C and D or non-hazardous locations only.
--

 WARNING
--

Restricted area of application

This equipment is suitable for use in Class I, Zone 2, Group IIC or non-hazardous locations only.

2.4 Important notices 100 to 240 VAC

Note on devices with power supply 100 to 240 V AC

 WARNING
Danger from line voltage The supply voltage for the devices listed is 100 to 240 VAC. This device can only function correctly and safely if it is transported, stored, set up, and installed correctly, and operated and maintained as recommended. Connecting and disconnecting may only be performed by an electrical specialist. Connect or disconnect power supply cables only when the power is turned off.

 WARNING
Devices with a 100 to 240 V AC power supply do not have an ATEX or IECEx approval. Devices with a 100 to 240 V AC power supply are not approved for use in hazardous areas according to EC-RL-94/9 ATEX or IECEx.

NOTICE
Securing cables with dangerous voltage Make sure that the connector cannot be released accidentally by pulling on the connecting cable. Lay the cables in cable ducts or cable channels and secure the cables, where necessary, with cable ties.

2.5 Safety requirements - Installation 100 to 240 VAC

Safety requirements for installation

According to the IEC 61131-2 standard and therefore in accordance with the EU directive 2006/95/EC (Low Voltage Directive), the devices are "open equipment" and in accordance with UL/CSA certification, they are an "open type".

To fulfill requirements for safe operation with regard to mechanical stability, flame retardation, stability, and shock-hazard protection, the following alternative types of installation are specified:

- Installation in a suitable cabinet.
- Installation in a suitable enclosure.
- Installation in a suitably equipped, enclosed control room.

Description

3.1 Unpacking and checking

Unpacking, checking

 WARNING
Do not use any parts that show evidence of damage
If you use damaged parts, there is no guarantee that the device will function according to the specification.
If you use damaged parts, this can lead to the following problems:
<ul style="list-style-type: none">• Injury to persons• Loss of the approvals• Violation of the EMC regulations
Use only undamaged parts.

1. Make sure that the package is complete.
2. Check all the parts for transport damage.

3.2 Components of the product XR-300M PoE

Components that ship with the SCALANCE XR324-4M PoE and XR324-4M PoE TS switches

The following components ship with a SCALANCE XR324-4M PoE or XR324-4M PoE TS:

- Device with C-PLUG exchangeable medium
- 2 mounting brackets and 8 screws (M3x5 recessed head, drive: Torx) for 19" rack installation
- Connecting cable for the diagnostics port
- Product CD with documentation and software

3.3 Power over Ethernet (PoE)

- For devices with a 100 to 240 VAC power supply:
 - A 2-pin terminal block for the power supply
 - A 2-pin terminal block for the signaling contact
- With devices with 24 V DC power supply:
 - 4-pin terminal block for the power supply
 - 2-pin terminal block for the signaling contact
 - 4 adhesive feet for desktop mounting

3.3 Power over Ethernet (PoE)

Power over Ethernet (PoE)

With PoE, the power for networked devices is carried via Ethernet. Here, there are two methods of supplying power:

- Alternative A

Here, the voltage is transferred on the data wires 1, 2, 3 and 6 of the Ethernet cable

Requirements for the Ethernet cable:

- For 10Base-T/100Base-TX, a 4-wire cable is adequate for data transmission and power supply.
- With 1000BASE-T, an 8-wire cable is necessary for data transmission.

- Alternative B

Power is transferred on the free wires 4, 5, 7 and 8 of the Ethernet cable.

Requirements for the Ethernet cable: For 10Base-T/100Base-TX/1000BASE-T, an 8-wire cable is needed.

PoE-compliant devices can be divided into the following groups:

- PSE - power sourcing equipment

These inject power onto the Ethernet cable.

- PD - powered devices

These are supplied with power via Ethernet.

PoE ports of the SCALANCE XR324-4M PoE and XR324-4M PoE TS switches

As PSEs, these devices supply PoE-compliant devices with power over Ethernet. The power required to supply the powered devices is generated internally on the switches, no extra power supply unit is necessary.

The switches use the "Alternative A" method. Per RJ-45 port, a maximum of 15.4 W are available for supplying a PoE-compliant device. If a Cat5/Cat5e cable with a maximum length of 100 m is used, the connected device can be supplied with a power of 12.95 W.

Note

The total power provided by the switches on all eight PoE ports is a maximum of 53.2 W.

The PoE ports meet the conditions listed in the IEEE 802.3af / IEEE 802.3at standard (type 1) for environment A , in other words power supply over Ethernet within a power supply system. For details of configuring and enabling PoE for individual ports, refer to the configuration manual SCALANCE X-300 / X-400 on the accompanying CD.

3.4 Product characteristics

Connection options of the SCALANCE XR324-4M PoE and XR324-4M PoE TS switches

The switches are partly modular devices and all have 24 ports.

- **16 fixed ports on the base device:**
 - Ports P1 to P8
8 PoE-compliant gigabit ports (RJ-45 jacks with securing collars) for connection of end devices or other network segments.
Non PoE-compliant end devices can also be connected to the PoE-compliant RJ-45 jacks because the switches check that the end devices are suitable for the PoE function before applying the power.
 - Ports P9 to P16
8 gigabit ports (RJ-45 jacks with securing collars) for connection of end devices or other network segments (no PoE).
- **8 modular ports via 4 module slots:**
4 media modules each with 2 ports are combined optically or electrically via the slots S1 to S4 depending on the application. End devices and other network segments are connected according to the media modules being used.



Image 3-1 XR324-4M PoE and XR324-4M PoE TS

 CAUTION
<p>Use only approved modules in the slots</p> <p>Possible module connection types:</p> <ul style="list-style-type: none"> • 2 x RJ-45 • 2 x FX100 • 2 x FX1000 • or 2 x SFP slots <p>With FX, single mode fibers or multimode fibers are possible. Connecting end devices or other network segments does not depend on the module slots.</p>

Slot number									S1		S2	
Port number	P1	P2	P3	P4	P5	P6	P7	P8	P1	P2	P1	P2
Slot number									S3		S4	
Port number	P9	P10	P11	P12	P13	P14	P15	P16	P1	P2	P1	P2
Connection type	Electrical: Gigabit Ethernet								Connection type depending on module used			

3.5 The SET / SELECT button

The SET/SELECT button is located on the top of the housing of devices of the X-300 EEC series. On all other devices, this button is on the front panel of the housing beside the LED display. The SET/SELECT button has several functions that are described below.

Change the display mode

By pressing the button briefly, you change to the display mode of the LED display. For more detailed information on this topic, refer to the section "LED display".

Resetting the device to the factory defaults

If you reset, all the changes you have made will be overwritten by factory defaults. Follow the steps outlined below:

1. Turn on display mode A. Display mode A is active when the "DM" LED is not lit. If this LED is lit or flashing, you will need to press the SET/SELECT briefly (possibly several times) until the "DM" LED goes off. If the SELECT/SET button is not pressed for longer than a minute, the device also turns on display mode A.
2. Hold down the SELECT/SET button for 12 seconds. If you release the button before the 12 seconds have elapsed, the reset is canceled.

Definition of the fault mask

Using the fault mask, you specify an individual "good status" for the connected ports and the power supply. Deviations from this status are then displayed as errors/faults.

1. Turn on display mode A or D. Display mode A is active when the "DM" LED is not lit. Display mode D is active when the "DM" LED flashes yellow/orange. If a different display mode is active, you will need to press the SET/SELECT briefly (possibly several times) until the required display mode is active.
2. Hold down the SET/SELECT button for five seconds. After three seconds, the "DM" LED begins to flash. If you release the button before the five seconds have elapsed, the previous fault mask will be retained.

Enable/disable the redundancy manager

1. Turn on display mode B. Display mode B is active when the "DM" LED is lit green. If a different display mode is active, you will need to press the SET/SELECT briefly (possibly several times) until display mode B is active.
2. Hold down the SET/SELECT button for five seconds. After three seconds, the "DM" LED begins to flash. If you release the button before the five seconds have elapsed, the action is aborted.
3. The result of the action depends on the initial situation:
 - If the redundancy manager and media redundancy were disabled, media redundancy is also enabled after enabling the redundancy manager.
 - If you disable the redundancy manager, media redundancy remains enabled.

3.6 LED display

The "RM" LED for the "redundancy manager" function

The "RM" LED indicates whether or not the device is operating in the role of redundancy manager and whether or not the ring is operating error-free.

LED color	LED status	Meaning
-	off	The device is not operating in the role of "redundancy manager".
green	on	The device is operating in the role of redundancy manager. The ring is working without problems, monitoring is activated.
green	flashes	The device is operating in the role of redundancy manager. An interruption has been detected on the ring and the device has switched through.

The "SB" LED for the standby function

This LED shows the status of the standby function.

LED color	LED status	Meaning
-	off	The standby function is disabled.
green	on	The standby function is enabled. The standby section is passive.
green	flashes	The standby function is enabled. The standby section is active.

The "F" LED for the fault status

The "F" LED (fault) provides information on the error/fault status of the device. While the device is starting up, this LED has the following meaning:

LED color	LED status	Meaning during the device startup
-	off	Device startup completed successfully.
red	on	Device startup not yet completed or a fault/error has occurred.
red	flashes	Bad firmware image.

During normal operation, the "F" LED provides the following information:

LED color	LED status	Meaning during operation
-	off	No operating problems.
red	on	The device has detected an error. The signaling contact opens.

The "DM" LED for the display mode

The "DM" LED (Display Mode) indicates which of the four display modes A, B, C or D is currently active. The meaning of the L1, L2 and P1, P2, ... LEDs depends on the display mode.

LED color	LED status	Meaning
-	off	Display mode A
green	on	Display mode B
orange	on	Display mode C
yellow/orange	flashes	Display mode D

Selecting the display mode

Press the SELECT/SET button to set the required display mode. If the SELECT/SET button is not pressed for longer than a minute, the device automatically changes to display mode A.

Pressing the SELECT/SET button starting at display mode A	Status of the "DM" LED	Display mode
-	off	Display mode A (default mode)
Press once	lit green	Display mode B

Pressing the SELECT/SET button starting at display mode A	Status of the "DM" LED	Display mode
Press twice	lit orange	Display mode C
Press 3 times	flashes yellow/orange	Display mode D

The "L1" and "L2" or "L" LEDs for the power supply

Whereas on other devices, the "L1" and "L2" LEDs indicate information about the power, on the SCALANCE X306-1LD FE, this is done by the "L" LED. A redundant power supply for this device can be recognized by the color of the LED.

Meaning in display mode A, B or C

LED	Color	Status	Meaning
L1 / L2	–	off	Power supply L1 / L2 lower than 17 V *)
	green	on	Power supply L1 / L2 higher than 17 V *)
L	-	off	Power supplies L1 and L2 less than 17 V or not connected.
	orange	on	Power supply L1 or L2 higher than 17 V (no redundant supply).
	green	on	Power supplies L1 and L2 higher than 17 V (redundant supply).
*) The following applies to the X-300EEC: <ul style="list-style-type: none"> • For devices with power supply unit 24 to 48 VDC: Limit voltage = 17 VDC • For devices with a multiple range power supply unit 100 to 240 VAC / 60 to 250 VDC: Limit voltage = 46.5 VDC or 80 VAC 			

Meaning in display mode D

LED	Color	Status	Meaning
L1 / L2	–	off	Power supply L1 / L2 is not monitored. If L1 / L2 falls below 17 V *) , the signaling contact does not respond.
	green	on	Power supply L1 / L2 is monitored. If L1 / L2 falls below 17 V *) , the signaling contact responds.
L	-	off	Power supplies L1 and L2 are not monitored. If L1 or L2 falls below 17 V, the signaling contact does not respond.
	orange	on	Power supply L1 or L2 is monitored. If L1 or L2 falls below 17 V, the signaling contact responds.
	green	on	Power supplies L1 and L2 are monitored. If L1 and L2 fall below 17 V, the signaling contact responds.
*) The following applies to the X-300EEC: <ul style="list-style-type: none"> • For devices with power supply unit 24 to 48 VDC: Limit voltage = 17 VDC • For devices with a multiple range power supply unit 100 to 240 VAC / 60 to 250 VDC: Limit voltage = 46.5 VDC or 80 VAC 			

Note**Devices of the X-300EEC product group**

When using only one power supply unit 24 VDC and two 24 VDC power supplies, the LEDs "L1" and "L2" signal the existence of the power supply L1 and L2.

When using two 24 VDC power supply units, the LEDs "L1" and "L2" signal the existence of the primary voltage and the secondary voltage for both power supply units. If the power supply is intact, a fault occurring on a power supply unit on the secondary side can be recognized.

The P1, P2, ... LEDs for the port status

The P1, P2, ... LEDs show information on the status of their port (transmission speed, mode, port monitoring). The meaning of these LEDs depends on the display mode ("DM" LED).

Meaning in display mode A

LED color	LED status	Meaning
-	off	No valid link to the port (for example station turned off or cable not connected).
green	on	Link exists and port in normal status. In this status, the port can receive and send data.
	flashes once per second	Link exists and port in "blocking" status. In this status, the port only sends and receives management data (no user data).
	flashes 3 times per second	Link exists and port turned off by management. In this status, no data is sent or received via the port.
	flashes 4 times per second	Port exists and is in the "monitor port" status. In this status, the data traffic of another port is mirrored to this port.
yellow	flashes / lit	Receiving data at port. With SCALANCE X-300 devices, both the receipt and the sending of data is indicated for the optical gigabit ports.

Meaning in display mode B

LED color	LED status	Meaning
-	off	Port operating at 10 Mbps.
green	on	Port operating at 100 Mbps.
orange	on	Port operating at 1000 Mbps.

If there is a problem on the connection and the type of transmission is fixed (autonegotiation off), the desired status, in other words the set transmission speed (1000 Mbps, 100 Mbps, 10 Mbps) continues to be displayed. If there is a problem on the connection and autonegotiation is active, the port LED goes off.

Meaning in display mode C

LED color	LED status	Meaning
-	off	Port operating in half duplex.
green	on	Port operating in full duplex.

Meaning in display mode D

LED color	LED status	Meaning
-	off	The port is not monitored; in other words, if a link is not established at the port, this does not trigger the signaling contact.
green	on	The port is monitored, in other words, if no connection was established at the port (for example no cable inserted), this triggers the signaling contact and an error state results.

3.7 C-PLUG

3.7.1 Area of application and function of the C-PLUG

Area of application

The C-PLUG (configuration plug) that ships with the product is an exchangeable memory medium for storing the configuration data of the device. The device can also be operated without a C-PLUG.

This allows fast and uncomplicated replacement of a device. The C-PLUG is taken from the previous device and inserted in the new device. The first time it is started up, the replacement device has the same configuration as the previous device except for the MAC address set by the vendor.

Principle

The data remains stored on the C-PLUG even when power is turned off. In terms of using the C-PLUG, there are two ways of operating the device:

- With unwritten C-PLUG

If an empty C-PLUG (factory settings or deleted with the Clean function) is inserted, all the configuration data of the device is saved to it automatically when the device starts up. Changes to the configuration during operation are saved without operator intervention on the C-PLUG if this is in the "ACCEPTED" status. This depends on how you configured your SCALANCE device. In this mode, the internal memory is neither read nor written. This mode is active when a C-PLUG is inserted.

- With written C-PLUG

A device with an accepted C-PLUG inserted uses the configuration data of the C-PLUG automatically when it starts up. Acceptance is possible only when the data was written by a compatible device type.

Response to errors

Inserting a C-PLUG that does not contain the configuration of a compatible device type, accidentally removing the C-PLUG or general malfunctions of the C-PLUG are signaled by the diagnostics mechanisms of the device (LEDs, Web-based management, SNMP, CLI and PROFINET diagnostics).

3.7.2 Removal and insertion of the C-PLUG (rack devices)

NOTICE
A C-PLUG may only be removed or inserted when the device is turned off.

Position of the C-PLUG with rack devices

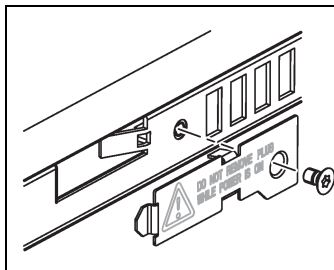

With rack devices, the slot is below a cover on the right-hand side of the housing. After undoing the screw (screw head Torx T10), the cover plate can be removed and the slot is accessible.

Removing the C-PLUG

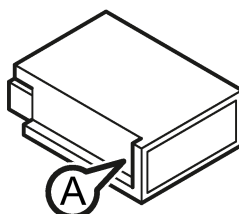
	<ol style="list-style-type: none">1. Turn off the power to the device.2. Remove the cover plate on the right-hand side of the device.3. Insert a screwdriver between the front edge of the C-PLUG (position A) and the slot and release the C-PLUG.4. Remove the C-PLUG and screw the cover plate firmly in place again.
---	---

Inserting the C-PLUG

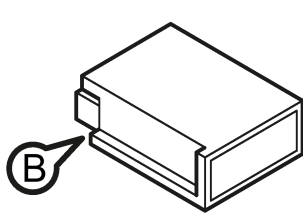
	<ol style="list-style-type: none">1. Turn off the power to the device.2. Remove the cover plate on the right-hand side of the device.3. The housing of the C-PLUG has a protruding ridge on the long side (position B). The slot has a groove at this position. Insert the C-PLUG correctly oriented into the slot.4. Secure the cover plate again with the screws.
---	--

Description

3.7 C-PLUG

Installation

4.1 Safety notices for installation

Safety notices

When installing the device, keep to the safety notices listed below.

 WARNING
If a device is operated in an ambient temperature of more than 50 °C, the temperature of the device housing may be higher than 70 °C. The device must therefore be installed so that it is only accessible to service personnel or users that are aware of the reason for restricted access and the required safety measures at an ambient temperature higher than 50 °C.

Safety notices on use in hazardous areas

General safety notices relating to protection against explosion

 WARNING
EXPLOSION HAZARD
The replacement of components may impair suitability for Class 1, Division 2 or zone 2.

 WARNING
When used in hazardous environments corresponding to Class I, Division 2 or Class I, Zone 2, the device must be installed in a cabinet or a suitable enclosure.

Safety notices for use according to ATEX and IECEx

If you use the device under ATEX or IECEx conditions you must also keep to the following safety notices in addition to the general safety notices for protection against explosion:

 WARNING
To comply with EC Directive 2014/34/EU (ATEX 114) or the conditions of IECEx, this enclosure or cabinet must meet the requirements of at least IP54 in compliance with EN 60529.

4.2 Suitable cables for temperatures above 70 °C - cable 50 °C - 70 °C (ATEX)

 **WARNING**

If the temperature of the cable or housing socket exceeds 70 °C or the branching point of conductors exceeds 80 °C, special precautions must be taken. If the equipment is operated in an air ambient in excess of 50 °C to 70 °C, only use cables with a permitted operating temperature of at least 80 °C.

4.3 Suitable cables for temperatures in excess of 70 °C (ATEX)

 **WARNING**

If the cable or conduit entry point exceeds 70 °C or the branching point of conductors exceeds 80 °C, special precautions must be taken. If the equipment is operated in an air ambient in excess of 50 °C, only use cables with admitted maximum operating temperature of at least 80 °C.

Further notes

 **CAUTION**

Use only approved components

If you use components and accessories that are not approved for SIMATIC NET devices or their target systems, this may violate the requirements and regulations for safety and electromagnetic compatibility.

Only use components approved for the SIMATIC NET devices.

NOTICE

Warming and premature aging of the IE switch due to direct sunlight

Direct sunlight can heat up the device and can lead to premature aging of the IE switch and its cabling.

Provide suitable shade to protect the IE switch against direct sunlight.

Note

During installation and operation, keep to the installation guidelines and safety notices described in this document and in the system manuals "Industrial Ethernet / PROFINET Industrial Ethernet" and "Industrial Ethernet / PROFINET passive network components".

You will find information on the system manuals in the section "Auto-Hotspot", in "Further documentation".

4.4 Notes on installation

 WARNING

If a device is operated in an ambient temperature of more than 50 °C, the temperature of the device housing may be higher than 70 °C. The device must therefore be installed so that it is only accessible to service personnel or users that are aware of the reason for restricted access and the required safety measures at an ambient temperature higher than 50 °C.

NOTICE**Use only approved components**

If you use components and accessories that are not approved for SIMATIC NET devices or their target systems, this may violate the requirements and regulations for safety and electromagnetic compatibility.

Use only components that are approved for SIMATIC NET devices.

 WARNING**Suitable cables for temperatures in excess of 70 °C**

If the cable or conduit entry point exceeds 70 °C or the branching point of conductors exceeds 80 °C, special precautions must be taken. If the equipment is operated in an air ambient in excess of 50 °C, only use cables with admitted maximum operating temperature of at least 80 °C.

 CAUTION

Provide suitable shade to protect the IE Switch X-300 against direct sunlight. This avoids unnecessary warming of the IE Switch X-300 and prevents premature aging of the IE Switch X-300 and cabling.

Note

When installing and operating the device, keep to the installation instructions and safety-related notices as described in this document and in the manual SIMATIC NET Industrial Ethernet Twisted Pair and Fiber Optic Networks.

4.5 19" rack mounting

 WARNING
Danger of injury by falling objects
If you do not use the supplied mounting brackets for 19"rack installation, it is not possible to install the device correctly.
Use only the supplied mounting brackets.
There are several ways of fixing the mounting brackets depending on the mounting position required.

19" rack mounting

19" rack mounting is possible for all rack devices identified by (XR). Refer to the technical specifications, Installation options table for each product group. The rack device is installed using two mounting brackets fitted to the front. After fitting the two mounting brackets, the rack device can then be installed in a 19" cabinet.

NOTICE
Do not cover the ventilation grilles
During installation, select a mounting position so that the ventilation grilles are always free to achieve adequate cooling. With normal orientation, the ventilation grilles are on the top, bottom and sides of the housing.
If you install more than one rack device, make sure that the permitted ambient conditions are met for all devices in the rack.

Minimum clearances

If you install the IE Switch in rack devices without forced ventilation or cooling, minimum clearances must be maintained to neighboring devices or the wall of the enclosure. By keeping to the minimum clearances, there is then an adequate stream of air for heat dissipation during operation. Keep to the following minimum clearances to neighboring devices.

Table 4- 1 Minimum clearances for installation in rack devices

Minimum clearance to devices below the switch	100 mm
Minimum clearance to devices above the switch	100 mm

NOTICE

Four-point mounting

If mechanical load is high, the device should be secured at four points. You will find more detailed information in the section "Mechanical stability in operation".

Mounting position for devices with ports on the front of the device

On the devices with the following MLFBs, the Ethernet ports or the slots for the modules are on the front of the device:

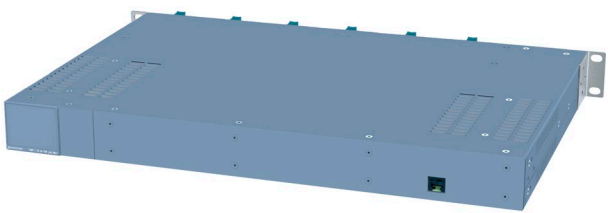

- 6GK5 324-4QG00-1AR2
- 6GK5 324-4QG00-3AR2
- 6GK5 324-4QG00-1CR2

Normal orientation of the device	
<ul style="list-style-type: none">• The LED display is on the left of the front panel of the housing.• The connectors for the signaling contacts and the power supply are on the right beside the LED display.• The Ethernet ports or the slots for the modules are also on the front of the housing.• The C-PLUG is on the right behind a protective panel secured with screws. (For more detailed information, refer to the section on the C-PLUG in the X-300 operating instructions.)• The ventilation grilles are on the top, bottom and sides of the housing.	
<ul style="list-style-type: none">• You will find the diagnostics port of the device on the back of the housing (for more detailed information, refer to Diagnostics port XR-300.)	

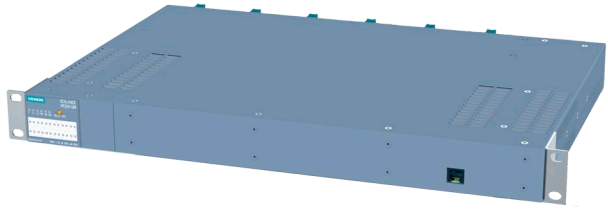

Mounting position for devices with ports on the rear of the device

On the devices with the following MLFBs, the Ethernet ports or the slots for the modules are on the rear of the device:

- 6GK5 324-4QG00-1HR2
- 6GK5 324-4QG00-3HR2

Normal orientation of the device	
<ul style="list-style-type: none">• The LED display is on the left of the front panel of the housing.• The diagnostics port of the device is also on the front of the device.• The ventilation grilles are on the top, bottom and sides of the housing.	 A perspective view of the SCALANCE XR-300M PoE device from the front. The device is a light blue, rectangular unit with a silver metal rack-mounting bracket on the right side. On the left side of the front panel, there is a small LED display and a diagnostics port. The top and bottom surfaces of the device feature ventilation grilles.
<ul style="list-style-type: none">• The connectors for the signaling contacts and the power supply are on the rear of the device.• The Ethernet ports or the slots for the modules are on the rear of the device: Slots for the modules are closed with dummy panels.• The C-PLUG is on the right behind a protective panel secured with screws. (For more detailed information, refer to the section on the C-PLUG in the X-300 operating instructions.)	 A perspective view of the SCALANCE XR-300M PoE device from the rear. The device is light blue with a silver metal rack-mounting bracket on the right side. The rear panel features several ports: signaling contacts, power supply connectors, Ethernet ports, and module slots. The module slots are covered with dummy panels. On the right side of the rear panel, there is a C-PLUG connector protected by a panel secured with screws.

Installation in a 19" rack

19" rack mounting		
1.	Select the required rack device and the 19" cabinet.	
2.	Fix the two mounting brackets with 4 screws each to the sides of the housing. The maximum tightening torque for these screws is 0.5 Nm.	
	<p>CAUTION: If you install a rack device with components inserted.</p> <p>The locking mechanisms of components installed in the rack device (for example the handles of media modules or the clips on the SFP) must be closed.</p> <p>See also installation of modular devices:</p> <ul style="list-style-type: none"> - Installing media modules in a slot - Installing an SFP in an SFP media module. 	
4.	Insert the rack device in the 19" cabinet and hold the rack device at the required height. Make sure that nothing is obstructing air from entering the ventilation grilles. Fit the securing screws to the two mounting brackets to secure the rack device in the 19" cabinet.	
5.	Fit the connectors for the power supply. Note that the SCALANCE X-300 is available for different power supplies (100 to 240 VAC and 24 VDC variants).	
6.	Fit the remaining connectors, for example the signaling contact.	

Removal

Removing from the rack	
1.	Turn off the power supply for the SCALANCE XR-300M.
2.	Disconnect all cables for data traffic and the connectors for the power supply and the grounding cable.
3.	Undo the screws on the mounting bracket and remove the rack device from the 19" cabinet. If necessary, release the locking mechanisms of components inserted in the rack device (for example handles on the media module or clips on the SFP) to be able to remove the media modules (MM900) or the transceiver (SFP).

Spare parts

Component	Description	Order number
SCALANCE XR300 Rack Mount Kit	Mounting bracket for 19" rack installation; for SCALANCE XR300; pack of 4;	6GK5980-2BA00-0AA4

4.6 Vertical installation of rack devices

Changed position of the mounting bracket

Devices of the XR-300M category can also be installed vertically in a cabinet door. In this position, the LED display must also be located at the front. In this case, the mounting brackets must be turned through 90° compared with rack mounting and secured to the side surfaces of the housing.

4.7 Desktop operation

NOTICE

Damage to the device due to overheating

The permitted device temperature of devices with a supply voltage of 100 to 240 VAC is exceeded in desktop operation. Desktop operation is not permitted for devices with a supply voltage of 100 to 240 VAC.

Install devices with a supply voltage of 100 to 240 VAC in a rack.

Only use devices with a supply voltage of 24 to 48 VDC for desktop operation.

Procedure

1. Remove the foil from one side of the adhesive feet and place the adhesive feet on the bottom of the housing.
2. Remove the other foils from the adhesive feet and position the device at the required location.
3. Fix the device in position by applying light pressure to the side edges of the housing. Under no circumstances apply pressure to the center of the device housing, the housing could otherwise be damaged.
4. Secure the cable for the power supply and any other cables required (signaling contact, diagnostics port) according to the descriptions in the section "Connecting up".

Spare parts

Component	Description	Order number
SCALANCE XR-300 Desk Mount Kit	Table feet; for SCALANCE XR300; pack of 4;	6GK5980-2CA00-0AA4

4.8 Installation of modular devices

4.8.1 Installation and removal of media modules

Safety notices

NOTICE
Use only approved media modules If you use media modules that are not approved by Siemens AG, there is no guarantee that the device will function according to the specification. If you use unapproved media modules, this can lead to the following problems: <ul style="list-style-type: none">• Damage to the device• Loss of the approvals• Violation of the EMC regulations Use only approved media modules.

NOTICE
Damage due to changing modules while the device is turned on Media modules for SCALANCE devices are not capable of hot plugging. Install or remove media modules only when the power supply of the device is turned off.

Note

Use media modules only in an approved modular device

Use an MM900 media module only for a device equipped with suitable slots for such modules. Example: X308-2M.

The names and labeling of the media modules differ

- Example: The device is called, for example, "MM992-2SFP" [6GK5 992-2AS00-8AA0], the labeling on the device is "9922AS". You will find detailed information on the labeling of the media modules in the "MM900 media modules" compact operating instructions.

⚠ CAUTION**Remember the orientation of media modules**

On modular devices, there are always two module slots arranged opposite each other. Remember the correct orientation when installing MM900 media modules.

Example:

- Install the first media module in slot 1.
- Install the second media module turned through 180 degrees in slot 2 opposite the first slot.

On modular devices for rack mounting, pairs of module slots are located one above the other in which modules can be inserted in a specific order:

Example of a rack device:

- Install the first media module in slot 1.
- Install the third media module turned through 180° in slot 3.

Other modules are then installed in slot 2 and 4.

The permitted operating temperature is decided by the fully equipped device (switch + media module + SFP transceiver).

With modular devices, it is not only the switch that decides the permitted operating temperature of the overall device but also the temperature ranges of the MM900 media modules and the SFP transceivers. You will find details in the technical specifications of the relevant components.

The following aspects can restrict the maximum permitted operating temperature:

- The orientation of the carrier device.
- The use of SFP transceivers.
- The use of transceivers of the types LH, LH+ or ELH.

Note**Slot number**

With modular devices, the MM900 media modules must be given a slot number. The slot number labels are supplied with the modular devices.

Additional safety notices for the XR 324-4M PoE TS**Note****Loss of conformity with the railway standard EN 50155**

If you install unvarnished modules in the XR 324-4M PoE TS, the device no longer meets the requirements of the railway standard EN 50155.

Only install varnished modules in the XR 324-4M PoE TS.



Installing a media module

The media module is inserted with the handle pulled out. When the handle is inserted, the media module is locked in the device.

Note

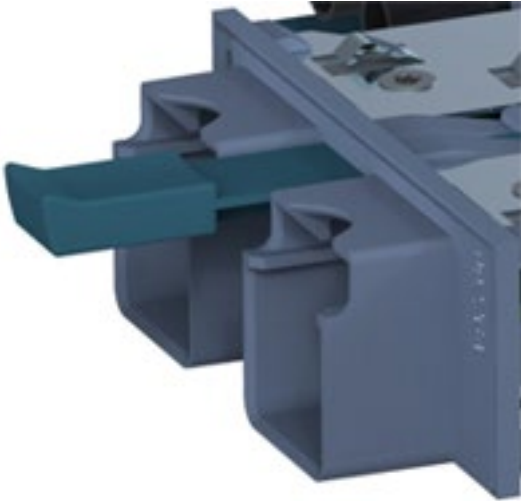
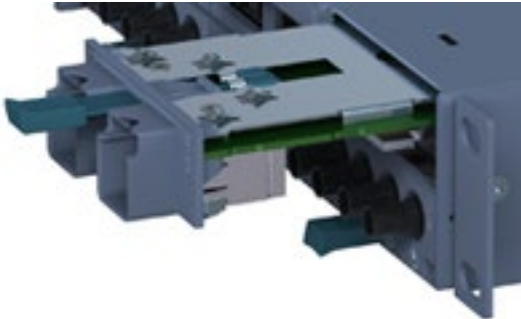
The figures in the following installation instructions show the installation of a media module in a rack device. The procedure for installation is identical for rack or compact devices.

1.	Select the required slot on the device (for example, X308-2M). Remove the dummy cover.	
2.	Pull out the handle on the selected media module.	
3.	Place the media module in the guide rails of the device slot. The media module is correctly installed when it clips easily into the device.	

4.	Push the handle back into the media module. This locks the media module in the device.	
5.	Insert the connectors.	

Removing a media module

 CAUTION
Risk of burns due to the high temperature of the module housing
Turn off the device and allow the device to cool down before you remove a media module.

1. Remove all connectors from the media module.
2. Pull out the handle of the media module and remove the media module from the device slot.
3. Fit the dummy cover.

Spare parts

Component	Description	Order number
SCALANCE Cover Set	Dummy covers; for SCALANCE X,XR,S; pack of 4;	6GK5980-2DA00-0AA4

4.8.2 SFP installation in SFP media module



NOTICE
Use only approved SFPs
If you use SFPs that are not approved by Siemens AG, there is no guarantee that the device will function according to the specification.
If you use unapproved SFPs, this can lead to the following problems:
<ul style="list-style-type: none">• Damage to the device• Loss of the approvals• Violation of the EMC regulations
Use only approved SFPs.

You can insert or remove the SFP during ongoing operation.

Inserting an SFP

Note
Only the media module MM992-2SFP may be fitted with approved SFPs. The SFP media module can be fitted with up to two SFPs.

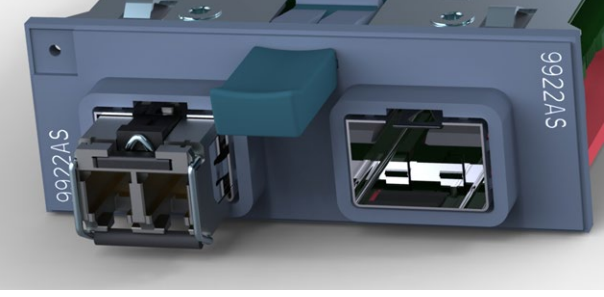
Device: Media module	Variant	[Order number] Labeling on the device	Figure
MM992-2SFP (SFP media module)	2 x 100/1000 Mbps	[6GK5 992-2AS00-8AA0] 9922AS	

1.	Select the required SFP media module in the slot of the device. (Example: X-308-2M, slot 2)	
2.	<p>Insert the SFP with the clip closed in the SFP media module.</p> <p>Notice: Closing the clip after insertion does not lock the device in the rack.</p>	
3.	The SFP can be heard to lock in place and is therefore firmly secured.	
4.	<p>Plug the connecting cable into the SFP.</p> <p>The connecting cable can be heard to lock in place and is then firmly secured.</p>	

Removing an SFP

1. Remove the cable connected to the SFP.
2. Open the clip on the SFP and remove the SFP from the SFP media module.

Notice: It must be possible to remove the SFP easy without using force.
3. Fit a blind plug to the SFP.

Connecting up

Safety notices on use in hazardous areas

General safety notices relating to protection against explosion

 WARNING
EXPLOSION HAZARD
Do not connect or disconnect cables to or from the device when a flammable or combustible atmosphere is present.

Safety notices when using the device according to Hazardous Locations (HazLoc)

If you use the device under HazLoc conditions you must also keep to the following safety notices in addition to the general safety notices for protection against explosion:

 WARNING
EXPLOSION HAZARD
DO NOT DISCONNECT WHILE CIRCUIT IS LIVE UNLESS AREA IS KNOWN TO BE NON-HAZARDOUS.

Safety notices for use according to ATEX and IECEx

If you use the device under ATEX or IECEx conditions you must also keep to the following safety notices in addition to the general safety notices for protection against explosion:

 WARNING
Take measures to prevent transient voltage surges of more than 40% of the rated voltage. This is the case if you only operate devices with SELV (safety extra-low voltage).

 WARNING
Before connecting up and commissioning the device, read the information in the section Auto-Hotspot

NOTICE

Failure of the data traffic due to contamination of optical plug-in connections

Optical sockets and plugs are sensitive to contamination of the end face. Contamination can lead to the failure of the optical transmission network.

Close unused optical sockets and plugs as well as pluggable transceivers and slots with the supplied protective caps.

Remove the protective caps only immediately before you use the plug-in connection.

5.1 Notes on commissioning

Note

Commissioning devices with redundancy mechanisms

If you use redundancy mechanisms ("HRP" media redundancy or "MRP" and/or redundant coupling of rings over standby coupling), open the redundant path before you insert a new or replacement device in an operational network. A bad configuration or attachment of the Ethernet cables to incorrectly configured ports causes overload in the network and a breakdown in communication.

A device may only be inserted in a network and connected in the following situations:

- **HRP/MRP:**
The ring ports of the device being inserted in the ring were configured as ring ports. The required redundancy mode must also be enabled (see "Configuration Manual SCALANCE X-300 / X-400", section "X-300 Ring Configuration"). If the device is intended to operate as the redundancy manager, "Redundancy manager enabled" must also be set.
 - **Standby coupling:**
"Standby connection" must be "enabled" and the "Standby connection name" must match the name of the partner device. You will also need to configure the port with "Enable Standby Port Monitoring" (see "Configuration Manual SCALANCE X-300 / X-400", section "X-300/X-400 Standby Mask").
-

5.2 Connecting functional ground

Optional grounding

Grounding (functional ground) is via the mounting bracket on the device or via the screw-in bolts on the rear of the device. To ground the device from the back, follow the steps below:

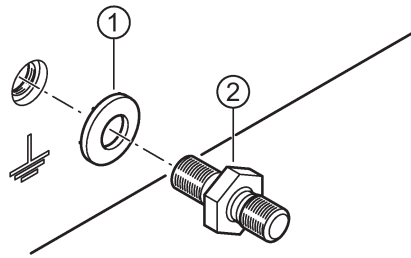

- 1 toothed washer
- 2 grounding bolt

The connector for the grounding cable is in the center of the rear panel of the device. Fit the toothed washer and tighten the grounding bolt with a maximum torque of 2 Nm.

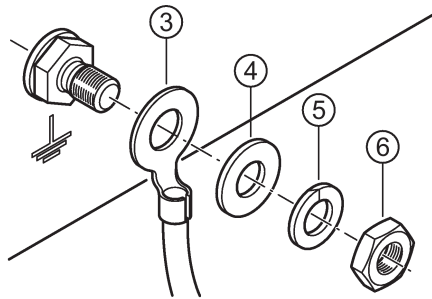

- 3 ground terminal with cable
- 4 washer
- 5 spring washer
- 6 nut

Fit parts 3, 4 and 5 as shown in drawing onto the grounding bolt and tighten the nut with a maximum torque of 1.5 Nm.

5.3 Signaling contact

5.3.1 24 V DC signaling contact (XR-300M)

24 V DC signaling contact



Note

Supply voltage at signaling contact for XR-300M and XR-300M-PoE

At the signaling contact, there is always a voltage of 24 VDC even if the device can be operated with 100 to 240 VAC.

- The signaling contact is connected to a 2-pin plug-in terminal block.
The signaling contact can be subjected to a maximum load of 100 mA (safety extra-low voltage SELV, 24 V DC).

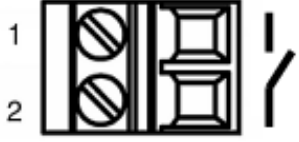
Table 5- 1 Pin assignment of the 24 VDC signaling contact

Pin number	Assignment
<p>1</p> 	
Pin 1	F1
Pin 2	F2

To wire up the signaling contact, use a copper cable of category 18-12 AWG or cable with a cross-section of 0.75 to 2.5 mm².

Spare parts

Component	Description	Order number
Terminal block 2-pin	2-pin terminal block for signaling contacts 24 to 48 VDC; for SCALANCE X,W,S,M; pack of 5;	6GK5980-0BB00-0AA

5.4 Diagnostics port

5.4.1 Diagnostics port rear

Description

Rack devices have a diagnostics port on the rear of the housing. This port is designed for an RJ-11 plug. A suitable connecting cable with an RJ-11 plug and a 9-pin D sub female connector for connection to the serial port of the PC ships with the SCALANCE XR-300.

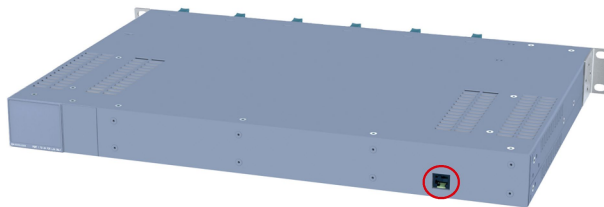

Diagnostics port on the rear of the device

Pin assignment

The following table shows the pin assignment of the RJ-11 plug and the D sub female connector:

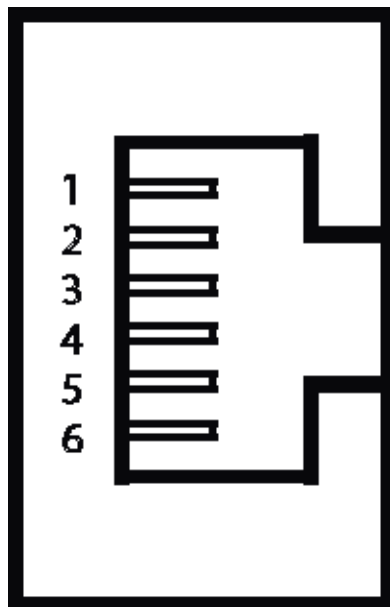



Image 5-1 RJ-11 jack (schematic)

RJ-11 plug		D-sub 9-pin, female	
Pin	Assignment	Pin	Assignment
1	n. c.	1	n. c.
2	n. c.	2	RD (Receive Data)
3	TD (Transmit Data)	3	TD (Transmit Data)
4	SG (Signal Ground)	4	n. c.
5	RD (Receive Data)	5	SG (Signal Ground)
6	n. c.	6	n. c.
		7	n. c.
		8	n. c.
		9	n. c.

5.5 Power supply

5.5.1 Power supply XR-300M PoE

Power supply of the IE Switches XR-300M PoE

 WARNING
Danger to life: 100 to 240 VAC
Please note that the IE Switches X 300PoE can have a 100 to 240 VAC or a 24 to 48 VDC power supply.
You can recognize the type of power supply from the labeling on the device and the labeling of the terminal block for the power supply of the switch.

5.5.2 Connecting devices with 24 VDC power supply

5.5.2.1 24 VDC - XR-300M PoE product group

Table 5- 2 24 VDC safety extra-low voltage overview

Device	Device version (power supply)	24 V safety extra-low voltage (SELV)
		can be connected redundantly
XR324-4M PoE	1 x 24 VDC	•
	1 x 24 VDC	•

See also

Connecting devices with 100 to 240 VAC power supply (Page 51)

5.5.2.2 Connecting the external 24 VDC power supply

24 V safety extra-low voltage (SELV)

<p> WARNING</p> <p>Safety extra low voltage</p> <p>The equipment is designed for operation with a directly connected safety extra-low voltage (SELV). (This does not apply to 100 V to 240 V devices.)</p> <p>The maximum current via the 24 V terminals is 8 A. You should therefore include a fuse that trips at a current higher than 8 A. The fuse must meet the following requirements:</p> <ul style="list-style-type: none"> • Suitable for DC (min. 60 V / max. 8 A) • Breaking current at least 10 kA • UL/CSA listed (UL 248-1 / CSA 22.2 No. 248.1) • Classes R, J, L, T or CC <p>As an alternative, the following requirements:</p> <ul style="list-style-type: none"> • Suitable for DC (min. 60 V / max. 8 A) • Breaking current at least 10 kA • Approved in compliance with IEC 60127-1 / EN 60127-1 • Breaking characteristics: B or C for a circuit breaker or slow-blow fuse
--

<p>⚠ CAUTION</p> <p>Damage to the device due to overvoltage</p> <p>One of the tests used to attest the immunity of devices of the IE Switches X300 to electromagnetic interference is the "surge immunity test" according to EN61000 4 5. This test requires overvoltage protection for the power supply lines. A suitable device is, for example, the Dehn Blitzductor BVT AVD 24 article no. 918 422 or a comparable protective element.</p> <p>Manufacturer: DEHN+SÖHNE GmbH+Co.KG, Postfach 1640, D92306 Neumarkt, Germany.</p> <p>Do not operate the SCALANCE X-300 without suitable overvoltage protection.</p>

Connecting to the power supply (SELV)

- The power supply is connected using a 4-pin plug-in terminal block.
- The power supply can be connected redundantly. Both inputs are isolated. There is no distribution of load. When a redundant power supply is used, the power supply unit with the higher output voltage supplies the IE Switch X-300 alone.
- The power supply is connected over a high resistance with the enclosure to allow an ungrounded set up. The two power inputs are non-floating.

Terminal block assignment (4-pin)

Table 5- 3 Pinout of the 24 V safety extra-low voltage (SELV)

Pin number	Assignment	Labeling (example)
Pin 1	L1+ (24 VDC)	
Pin 2	M1	
Pin 3	M2	
Pin 4	L2+ (24 VDC)	

To wire up the power connector, use a copper cable of category 20-12 AWG or cable with a cross-section of 1.0 to 2.5 mm².

Spare parts

Component	Description	Order number
Terminal block 4-pin	4-pin terminal block for power supply 24 to 48 VDC; for SCALANCE X,W,S,M; pack of 5;	6GK5980-1DB00-0AA5

5.5.3 Connecting devices with 100 to 240 VAC power supply

5.5.3.1 100 to 240 VAC XR-300M PoE product group

Table 5- 4 100 to 240 VAC power supply overview

Device	Device version (power supply)	100 ... 240 V power supply	
		Redundant	Single
XR324-4M PoE	1 x 100 to 240 VAC	-	•

5.5.3.2 Notes on the power supply 100 to 240 VAC

 WARNING
<p>Danger from line voltage</p> <p>The supply voltage for the devices listed is 100 to 240 VAC.</p> <p>This device can only function correctly and safely if it is transported, stored, set up, and installed correctly, and operated and maintained as recommended.</p> <p>Connecting and disconnecting may only be performed by an electrical specialist.</p> <p>Connect or disconnect power supply cables only when the power is turned off!</p>

 WARNING
<p>Devices with a 100 to 240 VAC power supply do not have an ATEX approval.</p> <p>Devices with a 100 to 240 V AC power supply are not approved for use in hazardous areas according to EC-RL-94/9 (ATEX).</p>

NOTICE
<p>Securing cables with dangerous voltage</p> <p>Make sure that the connector cannot be released accidentally by pulling on the connecting cable. Lay the cables in cable ducts or cable channels and secure the cables, where necessary, with cable ties.</p>

5.5.3.3 Fitting the connector for 100 to 240 V AC



⚠ WARNING
Danger from line voltage
If used with cables with more than two wires, correct functioning of the connector casing cannot be guaranteed because the two halves of the connector casing can come apart. If this occurs, you will also not be able to connect all the wires in the connector. Open wire ends may be dangerous due to line voltage.
Use only two-wire cables.

Procedure

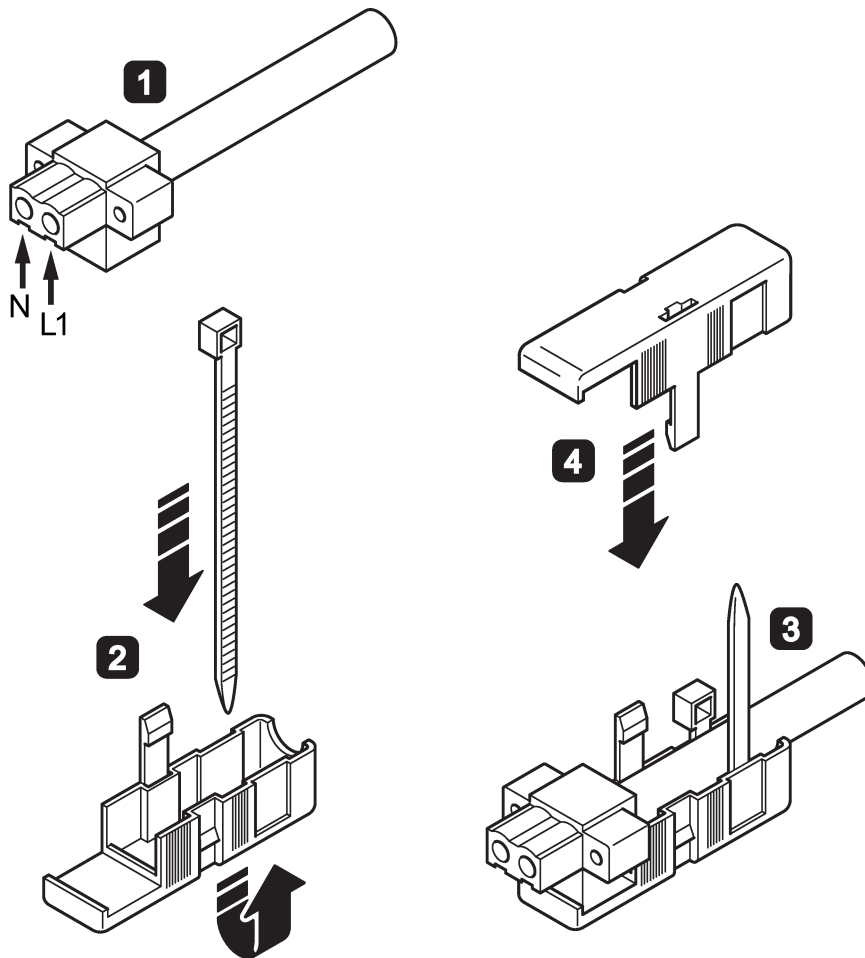

Follow the steps below to fit the connector to a two-wire cable:

1. Connect the cable to the terminal block. Strip the cable jacket only as far as necessary to be able to strip the insulation and connect up the wires.
2. Feed the supplied cable tie through the two openings in the lower part of the housing as shown in the figure.
3. Insert the terminal block with the connected cable in the lower part of the housing and tighten the cable tie. The cable must be securely held in the lower part of the housing by the cable tie. Cut off the excess cable tie.
4. Fit the upper part of the housing. The housing is correctly mounted when the two catches audibly click into place and are flush with the surface of the housing.

5.5.3.4 Connecting the 100 to 240 V AC power supply

Connecting to the power supply

The devices have a single power supply (1 x 100 to 240 V).

The power supply is connected using a 2-pin plug-in terminal block.

Terminal block assignment (2-pin)

Table 5- 5 Pin assignment of the 100 to 240 VAC power supply

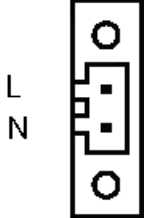
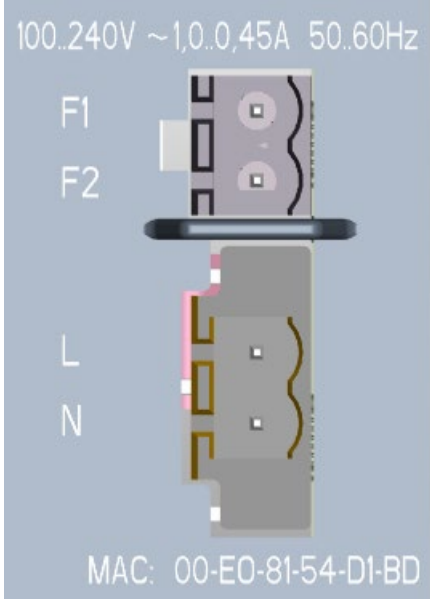
Assignment	Labeling
	

To wire up the power connector, use a copper cable of category 18-12 AWG or cable with a cross-section of 0.75 to 2.5 mm².

Spare parts

Component	Description	Order number
Terminal block 2-pin	2-pin terminal block for power supply 100 to 240 VAC incl. housing; for SCALANCE XR300 pack of 5;	6GK5980-1BC00-0AA5

Spare parts

Component	Description	Order number
Serial cable RJ-11/RS-232	preassembled, serial cable with RJ-11 and RS-323 plug; Length: 5 m; pack of 1;	6GK5980-3BB00-0AA5

Technical specifications

Note

Validity of the technical specifications

All the technical specifications described in this section that is not assigned to a specific device variant, version or a media module, apply to all device variants/versions of the product group.

6.1 Construction, installation and environmental conditions

Table 6- 1 Construction

Dimensions (W x H x D)	449 × 43.6 × 305 mm
Weight	6800 g
Degree of protection	IP20 (with closed service panel)

Table 6- 2 Installation options

Device version (power supply)	Installation options
24 VDC	<ul style="list-style-type: none"> • 19" rack • Desktop operation with adhesive feet
100 to 240 VAC	19" rack

Table 6- 3 Permitted ambient conditions

Storage/transport temperature	-40 °C to +85 °C
Max. relative humidity in operation at 25 °C	<= 95% (no condensation)
Max. ambient temperature at operating altitude	2000 m or above: -5 °C of the max. operating temperature ¹⁾ 3000 m or above: -10 °C of the max. operating temperature ¹⁾

¹⁾ See table: "Operating temperature depending on the media modules used"

6.1 Construction, installation and environmental conditions

Table 6- 4 Operating temperature depending on the media modules used

Media module ¹⁾	Installation direction	Operating temperature ²⁾
Without media module	Horizontal	-40 °C to +60 °C
	Vertical	-40 °C to +50 °C
MM992-2CUC MM992-2CUC (C) MM992-2CU MM992-2M12 (C) MM992-2VD MM991-2 MM991-2FM MM991-2LD MM991-2 (SC) MM991-2LD (SC) MM992-2 MM992-2 (C) MM992-2LD	Horizontal	-40 °C to +60 °C
	Vertical	-40 °C to +50 °C
MM991-2LH+ (SC) MM992-2LH MM992-2LH+ MM992-2ELH	Horizontal	Maximum 2 modules in slots 3 and 4: -40 °C ... +60 °C With more than 2 modules or other slot assignment: -40 °C to +50 °C
	Vertical	-40 °C to +50 °C
Media module MM992-2SFP with pluggable transceiver SFP991-1 SFP991-1LD SFP992-1 SFP992-1LD	Horizontal	-40 °C to +60 °C
	Vertical	-40 °C to +50 °C
Media module MM992-2SFP with pluggable transceiver SFP991-1LH+ SFP992-1LH SFP992-1LH+ SFP992-1ELH SFP991-1ELH200	Horizontal	Maximum 2 modules in slots 3 and 4: -40 °C ... +60 °C With more than 2 modules or other slot assignment: -40 °C to +50 °C
	Vertical	-40 °C to +50 °C
MM991-2P		Maximum 2 modules in slots 3 and 4: The slot above an MM991-2P may be used as follows: <ul style="list-style-type: none"> • Without media module: - 25 °C to + 50 °C • With media module MM992-2CUC or MM992-2CU: - 25 °C to + 40 °C

- 1) Only hardware product version 02 of the media modules is permitted.
The hardware product version is shown on the product. You can also read out this information from the device with the WBM or the CLI.
- 2) The permitted operating temperature depends on how the mounting device was installed. The installation is horizontal if the device labeling is from left to right. With a vertical installation, the device labeling is rotated through 90°.

6.2 Connectors and electrical data

Table 6- 5 Connection for end devices or network components

Max. number	24 ports
Electrical	Port 1 to 8 8 x RJ-45 jacks, MDI-X pinning, 10/100/1000 Mbps (half/full duplex) power supply for connected devices (PDs) using Power over Ethernet (PoE) according to IEEE 802.3af / 802.3at (type 1) Port 9 to 16: 8 x RJ-45 jacks with MDI-X assignment 10/100/1000 Mbps (half / full duplex)
Media module slots	4 x modular (2 ports per slot)
Transmitter output (optical) and receiver input	The values correspond to those of the permitted MM900 media modules and SFP transceivers.
Diagnostics port	RJ-11 jack

Table 6- 6 Electrical data: Power supply

Device version (power supply)	Redundant power supply unit	Redundant power supply possible	Power supply	
24 VDC	No	Yes	Rated voltage	24 VDC
			Voltage range	19.2 VDC - 28.8 VDC
			Permitted voltage range incl. total ripple	18.5 VDC - 30.2 VDC
100 to 240 VAC	No	No	100 to 240 VAC (85 to 264 V)	

Table 6- 7 Electrical data: Current consumption and power loss

Device version (power supply)	Current consumption	Effective power loss	Max. power consumption ¹⁾
24 VDC	4.2 A	46 W	100 W
100 to 240 VAC	1,3 ... 0.7 A	42 W	96 W

¹⁾ incl. PoE power supply of the connected PoE devices (PDs)

Table 6- 8 Electrical data: Overcurrent protection

Device version (power supply)	Overcurrent protection of the power supply Non-replaceable fuse
24 VDC	T 5 A / 250 V
100 to 240 VAC	T 2 A / 500 V

Table 6- 9 Electrical data: Signaling contact

Voltage via signaling contact	24 VDC
Switching capacity (resistive load)	max. 100 mA

Table 6- 10 Plug-in terminal block for connectors of the power supply and signaling contact

Device version (power supply)	Power supply	Signaling contact
24 VDC	1 x 4-pin	1 x 2-pin
100 to 240 VAC	1 x 2-pin	1 x 2-pin

Table 6- 11 Power over Ethernet at port P1 to P8

PoE function within a power supply system	According to IEEE 802.3af / 802.3at (type 1) for environment A
Method of PoE power feed	Alternative A (refer to the following table for the pin assignment)
Reserved power per port	15.4 W at port, of which the following can be used by the PD: 12.95 W
Overall power on all PoE ports	Max. 53.2 W

Table 6- 12 Electrical isolation

Between ports P1 to P8	No
Between ports P9 to P16	Yes
Between port groups P1 to P8 and P9 to P16	Yes
Between ports and ground	Yes
Between ports and 24 VDC / 230 VAC power input	Yes

Table 6- 13 Pin assignment of the Ethernet ports of the SCALANCE PoE switch

Pin number / wire ¹⁾	Assignment for data transmission	Assignment for power transfer (PoE). Alternative A (MDI-X)
Pin 1	RX+	V-
Pin 2	RX-	V-
Pin 3	TX+	V+
Pin 4	-	-
Pin 5	-	-
Pin 6	TX-	V+
Pin 7	-	-
Pin 8	-	-

¹⁾ with 4-wire industrial twisted-pair cables, the wires are connected to pins 1, 2, 3 and 6.

6.3 Cable lengths

Table 6- 14 Permitted cable lengths (copper cable - Fast Ethernet)

Cable type	Accessory (plug, outlet, TP cord)	Permitted cable length
IE TP torsion cable	with IE FC Outlet RJ-45 + 10 m TP cord	0 to 45 m + 10 m TP cord
	with IE FC RJ-45 Plug 180	0 to 55 m
IE FC TP Marine Cable IE FC TP Trailing Cable IE FC TP Flexible Cable	with IE FC Outlet RJ-45 + 10 m TP cord	0 to 75 m + 10 m TP cord
	with IE FC RJ-45 Plug 180	0 to 85 m
IE FC TP standard cable	with IE FC Outlet RJ-45 + 10 m TP cord	0 to 90 m + 10 m TP cord
	with IE FC RJ-45 Plug 180	0 to 100 m

6.3 Cable lengths

Table 6- 15 Permitted cable lengths (copper cable - gigabit Ethernet)

Cable type	Accessory (plug, outlet, TP cord)	Permitted cable length
IE FC Standard Cable, 4 × 2, 24 AWG IE FC Flexible Cable, 4 × 2, 24 AWG	with IE FC RJ-45 Plug 180, 4 × 2	0 to 90 m
IE FC Standard Cable, 4 × 2, 22 AWG	with IE FC Outlet RJ-45 + 10 m TP cord	0 to 60 m + 10 m TP cord
IE FC Flexible Cable, 4 × 2, 22 AWG	with IE FC Outlet RJ-45 + 10 m TP cord	0 to 90 m + 10 m TP cord

Note

Permitted cable lengths (fiber-optic cable - Fast Ethernet or gigabit)

The values correspond to those of the permitted MM900 media modules and SFP transceivers.

Block architecture of the SCALANCE XR-300M PoE

The XR-300M PoE handles the Ethernet frame traffic of the 24 ports with the aid of three switch blocks.

- The three switch blocks are connected in series (block 1 via block 2 to block 3).
- Gigabit wire speed is possible within a block (max. 8 ports per block).
- Between the blocks there is a bandwidth of 1 gigabit/s available, that must be shared by all ports for frame traffic between the blocks.

When operating solely with Fast Ethernet (100 Mbps), the XR devices support full wire speed via all blocks.

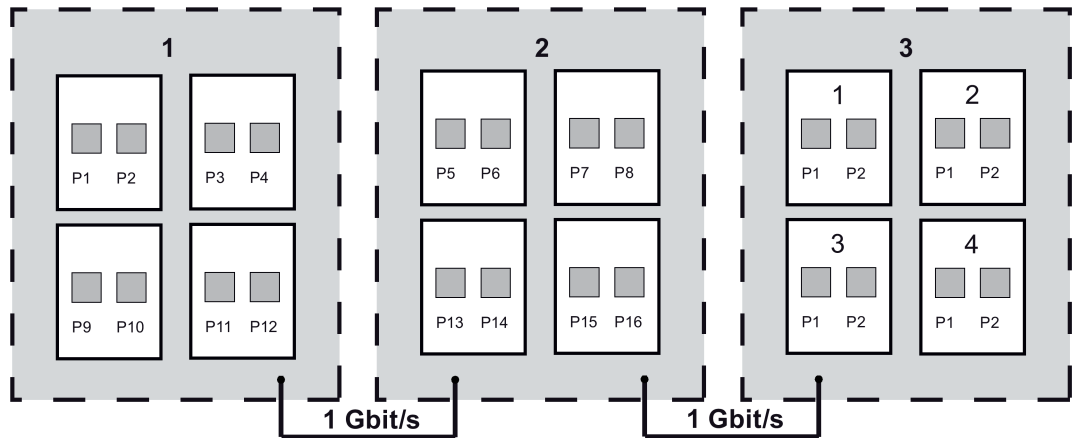

Image 6-1 Block architecture of the XR324-4M

6.4 Other properties

Table 6- 16 Switching properties

Max. number of learnable addresses	8000
Aging time	30 sec
Switching technique	Store and forward
Latency	5 μ s

Table 6- 17 Reconfiguration times for redundancy mechanisms

Redundancy mechanism	Reconfiguration times
HRP	300 ms
Standby link	300 ms
MRP	200 ms

Mean time between failure (MTBF)

The value in the following table applies to the basic device without media modules.

MTBF	> 15 years ¹⁾
------	--------------------------

¹⁾ This value applies at 40 °C.

In the calculation of the MTBF of a modular switch, the standard parts count applies; in other words, the reciprocals of all component failure rates are added.

The reciprocal of this total is the MTBF of the entire assembly.

$$MTBF_{total} = \frac{1}{\left(\frac{1}{MTBF_{basic\ device}} + \frac{1}{MTBF_{module\ 1}} + \dots + \frac{1}{MTBF_{module\ n}} \right)}$$

Table 6- 18 Full wire speed switching

Number of frames per second		At a frame length of
At 100 Mbps	At 1000 Mbps	
148810	1488095	64 bytes
84459	844595	128 bytes
45290	452899	256 bytes
23496	234962	512 bytes
11973	119732	1024 bytes
9615	96154	1280 bytes
8127	81274	1518 bytes

Note

The following applies to IE Switches X-300:

The number of IE Switches X-300 connected in a line influences the frame delay time. When a frame passes through the switch, this is delayed by the Store&Forward function of the IE Switch X-300 by the following values:

- at 64 bytes frame length: Delay of approx. 10 microseconds (at 100 Mbps)
- at 1500 bytes frame length: Delay of approx. 130 microseconds (at 100 Mbps)

This means, the more IE Switches X-300 a frame runs through, the higher the frame delay.

Dimension drawings

All dimensions in the drawings are in millimeters.

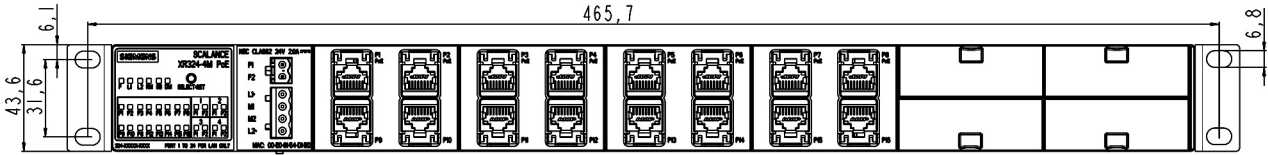

Image 7-1 XR324-4M PoE and XR324-4M PoE TS: Front view

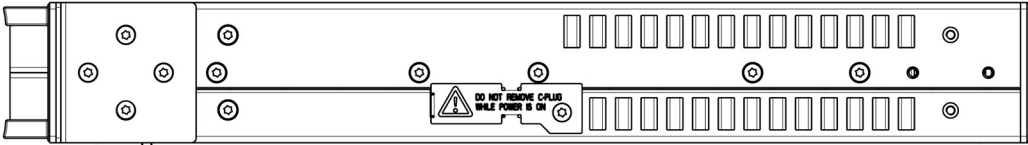

Image 7-2 XR324-4M PoE and XR324-4M PoE TS: Side view

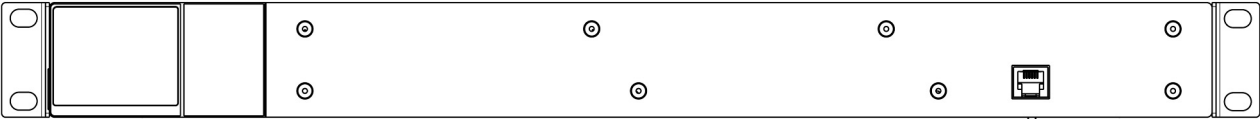

Image 7-3 XR324-4M PoE and XR324-4M PoE TS: Rear

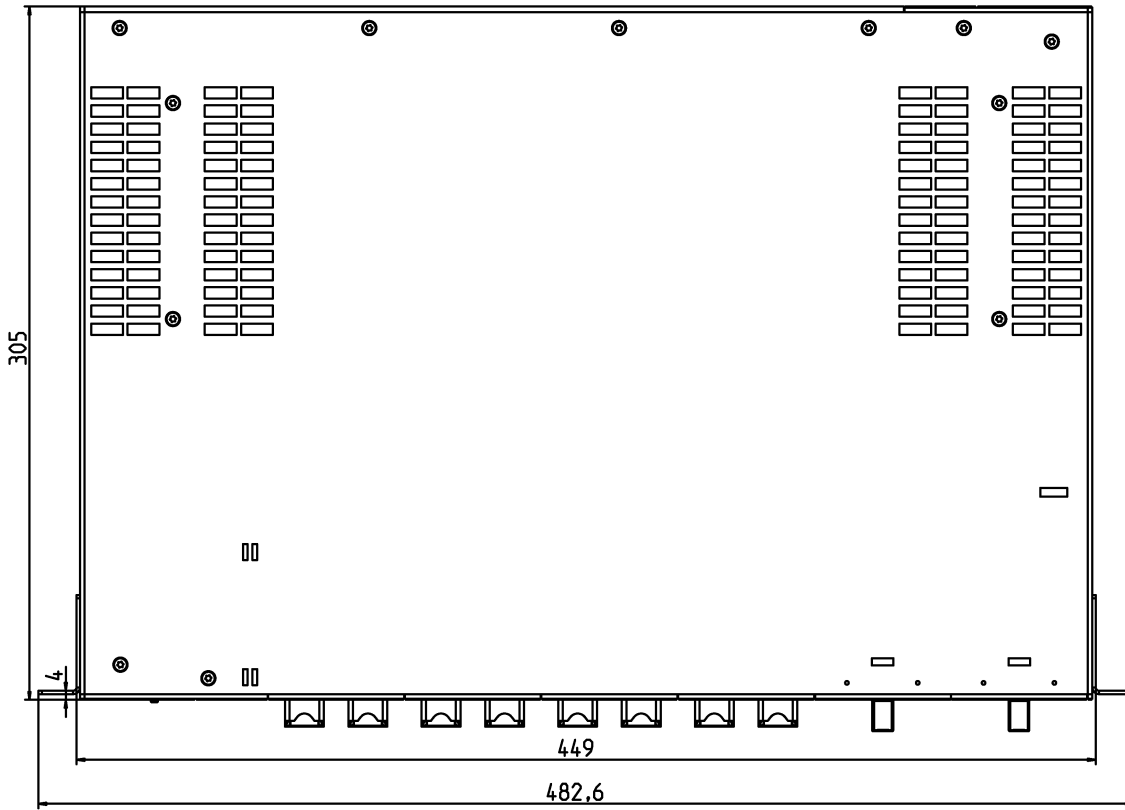

Image 7-4 XR324-4M PoE and XR324-4M PoE TS: From above

Approvals

8.1 XR-300M PoE approvals, certificates

Approvals issued

Note

Issued approvals on the type plate of the device

The specified approvals apply only when the corresponding mark is printed on the product. You can check which of the following approvals have been granted for your product by the markings on the type plate.

EC directives

SIMATIC NET products meet the requirements and aims of the following EC directives.

EMC directive (electromagnetic compatibility)

The SIMATIC NET products described in these operating instructions meet the requirements of EC directive 2004/108/EC "Electromagnetic Compatibility" for the following areas of application:

Field of application	Requirements	
	Emission	Immunity to interference
Industry	EN 61000-6-4 : 2007	EN 61000-6-2 : 2005

<p> WARNING</p> <p>Personal injury and property damage can occur</p> <p>The installation of expansions that are not approved for SIMATIC NET products or their target systems may violate the requirements and regulations for safety and electromagnetic compatibility.</p> <p>Only use expansions that are approved for the system.</p>
--

- **Keep to the installation guidelines**
The devices meet the requirements if you adhere to the installation and safety instructions contained in this documentation and in the following documentation when installing and operating the devices.
- **You can always find the latest documentation on the Internet**
The current descriptions of the currently available products can always be found on the Internet under the specified entry IDs/Internet pages:
 - "Industrial Ethernet / PROFINET Industrial Ethernet" System Manual
 - "Industrial Ethernet / PROFINET - Passive network components" System Manual
You will find information on the system manuals in the section "ID = 27069465 (<http://support.automation.siemens.com/WW/view/en/27069465>)", in "Further documentation".
 - "EMC Installation Guidelines" configuration manual
ID = 60612658 (<http://support.automation.siemens.com/WW/view/en/60612658>)
- **Working on the device**
To protect the device from electrostatic discharge, personnel must first discharge any electrostatic charge from their body before touching the device.

Note

The test was performed with a device and a connected communications partner that also meets the requirements of the standards listed above.

When operating the device with a communications partner that does not comply with these standards, adherence to the corresponding values cannot be guaranteed.

Machinery directive

The product is a component in compliance with the EC Machinery Directive 2006/42/EEC. According to the machinery directive, we are obliged to point out that the product described is intended solely for installation in a machine.

Before the final product can be put into operation, it must be tested to ensure that it conforms with the directive 2006/42/EEC.

Note

Note for the manufacturers of machines

This product is not a machine in the sense of the EC Machinery Directive. There is therefore no declaration of conformity relating to the EC Machinery Directive 2006/42/EEC for this product.

FM

The product meets the requirements of the standards:

- Factory Mutual Approval Standard Class Number 3611
- FM Hazardous (Classified) Location Electrical Equipment:
Non Incendive / Class I / Division 2 / Groups A,B,C,D / T4 and
Non Incendive / Class I / Zone 2 / Group IIC / T4

Note

Only variants with 24 VDC power supply meet the requirements of this approval.

C-Tick

The product meets the requirements of the AS/NZS 2064 standard (Class A).

cULus Approval for Information Technology Equipment

cULus Listed I. T. E.

Underwriters Laboratories Inc. complying with

- UL 60950-1 (Information Technology Equipment)
- CSA C22.2 No. 60950-1-03

Report no. E115352

Note

Only variants with 24 VDC power supply meet the requirements of this approval.

cULus approval for industrial control equipment

cULus Listed IND. CONT. EQ.

Underwriters Laboratories Inc. complying with

- UL 508
- CSA C22.2 No. 142-M1987

Report no. E85972

Note

Only variants with 100 to 240 VAC power supply meet the requirements of this approval.

cULus Approval Hazardous Location

cULus Listed I. T. E. FOR HAZ. LOC.

Underwriters Laboratories Inc. complying with

- UL 60950-1 (Information Technology Equipment)
- ANSI/ISA 12.12.01-2007
- CSA C22.2 No. 213-M1987

Approved for use in

Cl. 1, Div. 2, GP A, B, C, D T4

Cl. 1, Zone 2, GP IIC T4

Report no. E240480

Note

Only variants with 24 VDC power supply meet the requirements of this approval.

Railway approval

The TS variant of the device meets the requirements of the Railway standard EN 50155:2007 "Railway Applications - Electronic equipment used on rolling stock".

Note

When used on railway stock, a stabilized power supply must be used to comply with EN50155.

8.2 SCALANCE X-300 declaration of conformity

You will find the EC Declaration of Conformity for these products on the Internet at the following address:

SCALANCE X-300 declaration of conformity

(<https://support.industry.siemens.com/cs/ww/en/ps/15296/cert>)

1. Click on the entry "SCALANCE X-300 managed" in the navigation panel at the top edge of the window and from the drop-down list that opens, select the entry for your product group.
2. Select the entry "Certificate" from the "Entry type" drop-down list.

Result: A list of the available certificates is displayed.

8.3 Overview of XR-300M PoE approvals

Table 8- 1 Overview of the approvals

Device	Variant	c-UL-us Inf. Tech. Eq.	c-UL-us for Hazard- ous Loca- tions ¹⁾	c-UL-us Ind. Cont. Eq.	FM ¹⁾	C-TICK	CE	ATEX95 Zone 2 ¹⁾
XR324-4M PoE	1 x 24 VDC	•	•	-	•	•	•	•
	1 x 100 to 240 VAC	-	-	•	-	•	•	-
XR324-4M PoE TS	1 x 24 VDC	•	•	-	•	•	•	•

¹⁾ For temperature information "T.." or the maximum ambient temperature "Ta:..", refer to the type plate.

8.4 Mechanical stability in operation

The switch meets the following requirements for mechanical stability:

IEC 60068-2-6 (vibration)

- Mounting in the rack: (2-point mounting):
 - 10 to 58 Hz: 0.075 mm
 - 85 – 150 Hz: 1 g
 - 1 octave/min, 20 sweeps
- Individual mounting: (4-point mounting):
 - 5 to 8.51 Hz: 3.5 mm
 - 8.51 – 500 Hz: 1 g
 - 1 octave/min, 20 sweeps

IEC 60068-2-27 (shock)

- Mounting in the rack (2-point mounting):
 - 15 g, 11 ms duration, 6 shocks per axis

Appendix

A

A.1 The connector system M12/X coded according to IEC 61076-2-109

Description

M12 connectors with X coding are also suitable for transmission rates up to 210 Gbps (Cat6A) because the shields of the wire pairs can be led into the connectors. A further advantage is the availability of connectors with degree of protection IP67 with which the equipped devices are also suitable for adverse environmental conditions (dust, dampness). Due to the locking technology standardized for the M12 connectors a high resistance to vibration is achieved. Numerous SCALANCE devices therefore provide connection options for X coded M12 connectors.

Pin assignment



A Front view of M12 connector, X coded according to IEC61076-2-109

B Front view of RJ-45 connector, latching nose at the top, with pin assignment according to EIA/TIA 568B

Pin	M12/X coded		RJ-45 according to EIA/TIA 568B	
	Wire color	Signal	Wire color	Signal
1	White / orange	TX+	White / orange	TX+
2	Orange	TX-	Orange	TX-
3	White / green	RX+	White / green	RX+
4	Green	RX-	Blue	
5	White / brown		White / blue	
6	Brown		Green	RX-
7	White / blue		White / brown	
8	Blue		Brown	

Index

A

ATEX, 11

G

Glossary, 6

H

Hazardous (Ex) area, 11

S

Safety instructions, 9

Safety notices

for installation, 27

general, 9

Use in hazardous areas, 9, 27

SIMATIC NET glossary, 6

System manual, 29, 66

