

SIEMENS

SIMATIC NET

Industrial Ethernet switches SCALANCE X-400



Operating Instructions

<u>Introduction</u>	1
<u>Safety instructions</u>	2
<u>Description</u>	3
<u>Installation</u>	4
<u>Connecting</u>	5
<u>Configuration / project engineering</u>	6
<u>Approvals</u>	7
<u>Technical specifications</u>	8
<u>Dimension drawings</u>	9

Legal information

Warning notice system

This manual contains notices you have to observe in order to ensure your personal safety, as well as to prevent damage to property. The notices referring to your personal safety are highlighted in the manual by a safety alert symbol, notices referring only to property damage have no safety alert symbol. These notices shown below are graded according to the degree of danger.

 DANGER
indicates that death or severe personal injury will result if proper precautions are not taken.
 WARNING
indicates that death or severe personal injury may result if proper precautions are not taken.
 CAUTION
indicates that minor personal injury can result if proper precautions are not taken.
NOTICE
indicates that property damage can result if proper precautions are not taken.

If more than one degree of danger is present, the warning notice representing the highest degree of danger will be used. A notice warning of injury to persons with a safety alert symbol may also include a warning relating to property damage.

Qualified Personnel

The product/system described in this documentation may be operated only by **personnel qualified** for the specific task in accordance with the relevant documentation, in particular its warning notices and safety instructions. Qualified personnel are those who, based on their training and experience, are capable of identifying risks and avoiding potential hazards when working with these products/systems.

Proper use of Siemens products

Note the following:

 WARNING
Siemens products may only be used for the applications described in the catalog and in the relevant technical documentation. If products and components from other manufacturers are used, these must be recommended or approved by Siemens. Proper transport, storage, installation, assembly, commissioning, operation and maintenance are required to ensure that the products operate safely and without any problems. The permissible ambient conditions must be complied with. The information in the relevant documentation must be observed.

Trademarks

All names identified by ® are registered trademarks of Siemens AG. The remaining trademarks in this publication may be trademarks whose use by third parties for their own purposes could violate the rights of the owner.

Disclaimer of Liability

We have reviewed the contents of this publication to ensure consistency with the hardware and software described. Since variance cannot be precluded entirely, we cannot guarantee full consistency. However, the information in this publication is reviewed regularly and any necessary corrections are included in subsequent editions.

Table of contents

1	Introduction	7
1.1	Preface X400	7
2	Safety instructions	11
3	Description	13
3.1	Basic information on Ethernet switching	13
3.2	Network topologies	15
3.2.1	Linear structure	15
3.2.2	Star/tree structure	17
3.2.3	Ring with redundancy manager	19
3.2.4	Options of media redundancy	22
3.2.5	Media redundancy in ring topologies	23
3.2.6	Redundant coupling of network segments.....	25
3.3	System description of SCALANCE X-400	26
3.3.1	Properties, functionality and features of SCALANCE X-400	26
3.3.2	Ports of SCALANCE X-400	29
3.3.2.1	10Base-T / 100Base-TX	29
3.3.2.2	1000Base-T	30
3.3.2.3	100Base-FX	31
3.3.2.4	1000Base-SX.....	32
3.3.2.5	1000Base-LX	32
3.3.3	Compatibility of SCALANCE X-400	33
3.4	Description of the product.....	34
3.4.1	Product characteristics.....	34
3.4.2	SCALANCE X414-3E basic device.....	35
3.4.2.1	SCALANCE X414-3E power module.....	39
3.4.2.2	SCALANCE X414-3E digital inputs	40
3.4.2.3	SCALANCE X414-3E switch functionality	41
3.4.2.4	SCALANCE X414-3E ports	42
3.4.3	SCALANCE X408-2 basic device	44
3.4.3.1	SCALANCE X408-2 power module	47
3.4.3.2	SCALANCE X408-2 switch functionality.....	48
3.4.3.3	SCALANCE X408-2 ports.....	49
3.4.4	X-400 media modules	51
3.4.4.1	Overview of the media modules for SCALANCE X-400	51
3.4.4.2	Fast Ethernet media module MM491-2 (100Base-FX).....	55
3.4.4.3	Fast Ethernet media module MM491-2LD (100Base-FX)	56
3.4.4.4	Fast Ethernet media module MM491-2LH+ (100Base-FX)	57
3.4.4.5	Gigabit media module MM492-2 (1000Base-SX)	57
3.4.4.6	Gigabit media module MM492-2 LD (1000Base-LX).....	58
3.4.4.7	Gigabit media module MM492-2LH (1000Base-LX).....	59
3.4.4.8	Gigabit media module MM492-2LH+ (1000Base-LX)	59
3.4.4.9	Gigabit media module MM492-2ELH (1000Base-LX)	60

3.4.5	SCALANCE X414-3E extender modules	61
3.4.5.1	Extender for twisted pair EM495-8.....	61
3.4.5.2	EM496-4 extender for media modules.....	63
3.4.6	C-PLUG (configuration plug).....	65
3.4.7	SCALANCE X-400 covers and dummy covers.....	68
3.4.7.1	SCALANCE X414-3E covers/dummy covers	68
3.4.7.2	SCALANCE X408-2 covers/dummy covers.....	73
4	Installation	77
4.1	Safety notices for installation	77
4.2	Installing / uninstalling the SCALANCE X-400.....	79
4.2.1	Installing / uninstalling with an S7-300 standard rail.....	80
4.2.2	Installing / uninstalling with a 35 mm DIN rail	81
4.3	Installing / removing the media modules, covers, and dummy cover	85
4.3.1	Installing / removing a media module	85
4.3.2	Fitting / removing a cover/dummy cover	87
4.4	Installing / uninstalling the extender modules for SCALANCE X414-3E	89
4.4.1	Installing/uninstalling the EM495-8 twisted pair extender for SCALANCE X414-3E.....	89
4.4.2	Installing / uninstalling the EM496-4 media module extender for SCALANCE X414-3E	93
5	Connecting	99
5.1	Safety when connecting up.....	99
5.2	Ports	101
5.2.1	Connectors of the power supply (X1) of the SCALANCE X-400	101
5.2.2	Connectors of the signaling contact and grounding strap (X2) of the SCALANCE X-400	102
5.2.3	Connectors of the digital inputs of the SCALANCE X414-3E	104
5.2.4	Connectors for the twisted pair cables.....	105
5.2.5	Connectors for fiber-optic cables	109
5.2.6	Fitting IE FC RJ-45 Plug 180	111
6	Configuration / project engineering.....	113
6.1	Replacing a device.....	113
6.2	Slot numbers of the modules and covers	114
6.3	Factory default	115
6.4	Operator controls	117
6.4.1	DIL switches of the SCALANCE X414-3E	117
6.4.2	SELECT/SET button	121
6.5	LED display	122
6.5.1	Startup behavior of the SCALANCE X-400	123
6.5.2	Selecting the display modes	124
6.5.3	LED display - power module	124
6.5.4	LED display - CPU module	126
6.5.5	LED display of the ports (DMode A through DMode D).....	127
6.6	Replacing the C-PLUG	130
6.7	Show Location.....	132
7	Approvals	133

8	Technical specifications	139
8.1	SCALANCE X414-3E and X408-2 - technical specifications.....	139
8.2	Media module MM491-2 (100Base-FX) - technical specifications	144
8.3	Media module MM491-2LD (100Base-FX) - technical specifications.....	145
8.4	Media module MM491-2LH+ (100Base-FX) - technical specifications.....	146
8.5	Media module MM492-2 (1000Base-SX) - technical specifications	147
8.6	Media module MM492-2LD (1000Base-LX) - technical specifications.....	148
8.7	Media module MM492-2LH (1000Base-LX) - technical specifications.....	149
8.8	Media module MM492-2LH+ (1000Base-LX) - technical specifications.....	150
8.9	Media module MM492-2ELH (1000Base-LX) - technical specifications	151
8.10	Extender module EM495-8 - technical specifications	152
8.11	Extender module EM496-4 - technical specifications	153
9	Dimension drawings.....	155
	Index.....	163

Introduction

1.1 Preface X400

Purpose of the Operating Instructions

These Operating Instructions describe the functions of the SCALANCE X-400 product line of modular Industrial Ethernet switches and support you during installation, commissioning, and troubleshooting on site.

You will find information on configuring in the *separate Configuration Manual - SCALANCE X-400*.

"*Operating Instructions (compact)*" are also supplied with the product.

Validity of the Operating Instructions

These operating instructions are valid for the following products:

- Industrial Ethernet Switch SCALANCE X414-3E
order number: 6GK5 414-3FC00-2AA2
- Industrial Ethernet Switch SCALANCE X414-3E
order number: 6GK5 414-3FC10-2AA2
- Industrial Ethernet Switch SCALANCE X408-2
order number: 6GK5 408-2FD00-2AA2
- Media module MM491-2
order number: 6GK5 491-2AB00-8AA2
- Media module MM491-2LD
order number: 6GK5 491-2AC00-8AA2
- Media module MM491-2LH+
order number: 6GK5 491-2AE00-8AA2
- Media module MM492-2
order number: 6GK5 492-2AL00-8AA2
- Media module MM492-2LD
order number: 6GK5 492-2AM00-8AA2
- Media module MM492-2LH
order number: 6GK5 492-2AN00-8AA2
- Media module MM492-2LH+
order number: 6GK5 492-2AP00-8AA2
- Media module MM492-2ELH
order number: 6GK5 492-2AQ00-8AA2

- Extender module EM495-8
order number: 6GK5 495-8BA00-8AA2
- Extender module EM496-4
order number: 6GK5 496-4MA00-8AA2

Names of the devices in these operating instructions

The descriptions in these operating instructions always apply to the devices of the SCALANCE X-400 product line listed under "Validity of the Operating Instructions" in this document unless the description relates to a specific device of the product line. In the remainder of the description, the devices are called **IE Switches X-400**.

Further documentation

For help on configuration and diagnostics using Web-based management, the CLI command line, or SNMP, refer to the following documentation:

- SCALANCE X-300 SCALANCE X-400 Configuration Manual
C79000-G89xx-C187-06
(xx = German 00, English 76, French 77, Italian, 72 Spanish 78)
This configuration manual is available on the following media:
 - On the supplied CD
 - On the Internet at the address
<http://support.automation.siemens.com/WW/view/xx/19625108>
(xx = German 00, English 76, French 77, Italian 72, Spanish 78)
- SIMATIC NET Twisted Pair and Fiber Optic Networks
This manual is available on the following media:
 - In paper form under the order number C79000-G89xx-C125
(xx = German 00, English 76, French 77, Italian 72, Spanish 78)
 - On the Internet at the address
<http://support.automation.siemens.com/WW/view/xx/8763736>
(xx = German de, English en, French fr, Italian it, Spanish es)

Standards and approvals

The IE Switches X-400 meet the requirements for the CE mark. For more detailed information, refer to the appendix of these Operating Instructions.

Further documentation

In the system manuals "Industrial Ethernet / PROFINET Industrial Ethernet" and "Industrial Ethernet / PROFINET passive network components", you will find information on other SIMATIC NET products that you can operate along with the devices of this product line in an Industrial Ethernet network.

There, you will find among other things optical performance data of the communications partner that you require for the installation.

You will find the system manuals here:

- On the data medium that ships with some products:
 - Product CD / product DVD
 - SIMATIC NET Manual Collection
- On the Internet pages of Siemens Industry Online Support under the following entry IDs:
 - 27069465 (<http://support.automation.siemens.com/WW/view/en/27069465>)
Industrial Ethernet / PROFINET Industrial Ethernet System Manual
 - 84922825 (<http://support.automation.siemens.com/WW/view/en/84922825>)
Industrial Ethernet / PROFINET - Passive network components System Manual

SIMATIC NET manuals

You will find the SIMATIC NET manuals here:

- On the data medium that ships with some products:
 - Product CD / product DVD
 - SIMATIC NET Manual Collection
- On the Internet pages of Siemens Industry Online Support.

See also

Siemens Industry online support (<http://support.automation.siemens.com/WW/view/en>)

Link to the area "Industrial Communication"

(<http://support.automation.siemens.com/WW/view/en/10805878/130000>)

SIMATIC NET glossary

Explanations of many of the specialist terms used in this documentation can be found in the SIMATIC NET glossary.

You will find the SIMATIC NET glossary here:

- SIMATIC NET Manual Collection or product DVD
The DVD ships with certain SIMATIC NET products.
- On the Internet under the following entry ID:
50305045 (<http://support.automation.siemens.com/WW/view/en/50305045>)

Safety instructions

Read the safety notices

Note the following safety notices. These relate to the entire working life of the device.

You should also read the safety notices relating to handling in the individual sections, particularly in the sections "Installation" and "Connecting up".

Safety notices on use in hazardous areas

General safety notices relating to protection against explosion

 WARNING
EXPLOSION HAZARD
DO NOT OPEN WHEN ENERGIZED.

Safety notices for use according to ATEX and IECEx

If you use the device under ATEX or IECEx conditions you must also keep to the following safety notices in addition to the general safety notices for protection against explosion:

 WARNING
EXPLOSION HAZARD
Do not press the SELECT/SET button when there is an explosive atmosphere.

Safety notices when using the device according to Hazardous Locations (HazLoc)

If you use the device under HazLoc conditions you must also keep to the following safety notices in addition to the general safety notices for protection against explosion:

This equipment is suitable for use in Class I, Division 2, Groups A, B, C and D or non-hazardous locations only.

This equipment is suitable for use in Class I, Zone 2, Group IIC or non-hazardous locations only.

Description

3.1 Basic information on Ethernet switching

Ethernet switching

Ethernet switches forward data packets directly from the input port to the appropriate output port during data exchange based on the address information. Ethernet switches operate on a direct delivery basis.

Essentially, switches have the following functions:

- Connection of collision domains / subnets
Since repeaters and star couplers (hubs) operate at the physical level, their use is restricted to the span of a collision domain. Switches connect collision domains. Their use is therefore not restricted to the maximum span of a repeater network. On the contrary, extremely large networks with large spans are possible with switches.
- Containing load
By filtering the data traffic based on the Ethernet (MAC) addresses, local data traffic remains local. In contrast to repeaters or hubs, which distribute data unfiltered to all ports / network nodes, switches operate selectively. Only data intended for nodes in other subnets is switched from the input port to the appropriate output port of the switch. To make this possible, a table assigning Ethernet (MAC) addresses to output ports is created by the switch in a "teach-in" mode.
- Limiting errors to the affected subnet.
By checking the validity of a data packet on the basis of the checksum which each data packet contains, the switch ensures that bad data packets are not transported further. Collisions in one network segment are not passed on to other segments.

The need for Industrial Ethernet switches

With over 95% of LANs based on Ethernet, this is the most commonly used technology. The use of switches is particularly important. They allow extensive networks with large numbers of nodes to be set up, increase the data throughput, and simplify network expansion.

The modular IE Switches X-400 from SIMATIC NET are designed for use in high-speed plant networks that will also meet future requirements. Thanks to their modular design, the IE Switches X-400 can be adapted to the task in hand in terms of number of ports and transmission medium. Due to support of IT standards such as VLAN, RSTP, IGMP, and GARP makes seamless integration of automation networks in existing office networks possible.

The devices are designed for use in switching cubicles and cabinets.

Technical options (network topologies)

The modularity of IE Switches X-400 simplifies the expansion of a network regardless of the network topology.

You can use an IE Switch X-400 in the following network topologies:

- Linear structure
- Star/tree structure
- Ring with redundancy manager

The maximum cable length is 70 km for single mode Fast Ethernet transmission and single mode gigabit transmission. Mixed operation within the topology, for example between SCALANCE X414-3E and OSMs/ESMs is possible regardless of the structure being used (ring with redundancy manager, star, or linear structure).

Using an IE Switch X-400 as the redundancy manager in a ring with redundancy manager provides greater availability. If there is an interruption on the connection between these switches, the IE Switch X-400 used as redundancy manager acts like a switch and in a very short time creates a line from the ring with redundancy manager. As a result, a functional, end-to-end structure is restored. For more detailed information, refer to the configuration manual "SCALANCE X-300 and SCALANCE X-400 Industrial Ethernet Switches".

3.2 Network topologies

3.2.1 Linear structure

Functional description

Linear structures can be created with IE Switches X-400. The cascading depth and total span of a network are limited only by the signal propagation times of the communication connections.

Properties of the linear structure

Each IE Switch X-400 communicates over a TP or FO cable with a neighboring Ethernet switch. Communication is possible over the optical or the electrical ports.

For more detailed information, refer to the table below.

Table 3- 1 Optical ports (on the slots)

Media module	SCALANCE X414-3E	SCALANCE X408-2
Gigabit MM492-2, MM492-2LD, MM492-2LH, MM492-2LH+ or MM492-2ELH	5	5 and 6
Fast Ethernet MM491-2, MM491-2LD or MM491-2LH+	6 and 7 with extender: 12, 13, 14 and 15	5 and 6

Table 3- 2 Electrical ports (on the slots)

Transmission rate	SCALANCE X414-3E	SCALANCE X408-2
Gigabit	5	5 and 6
Fast Ethernet	5 and 9 to 11 with extender: 12 and 13	5, 6 and 8

With the fault mask, it is possible to monitor the port states using the signaling contact. In addition to interconnecting the switches, it is also possible to connect one or more end devices to every IE Switch X-400.

Configuration example

Sample configuration with SCALANCE X414-3E, SIMATIC S7-300/400 and operator panel as end devices.

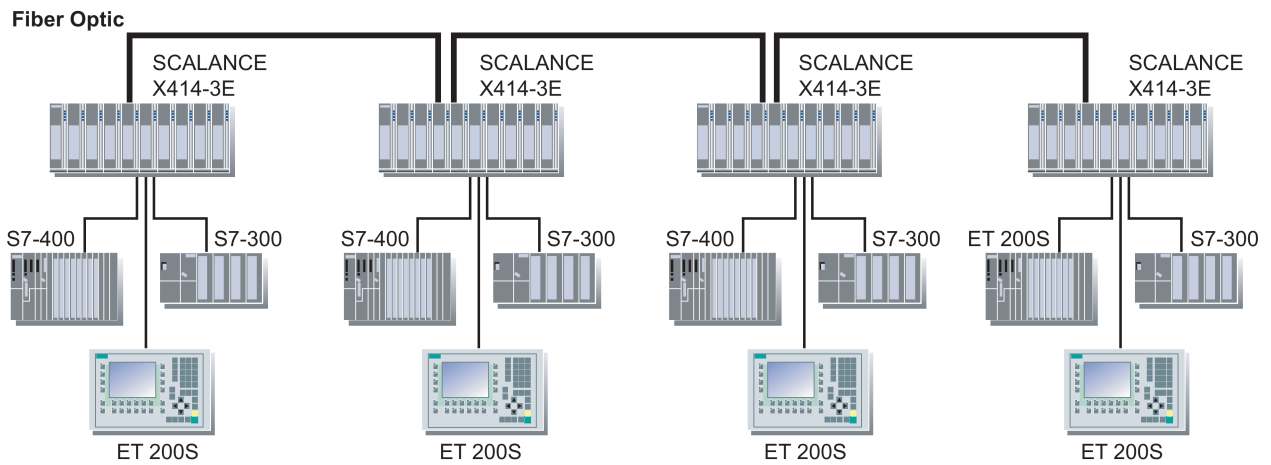

Figure 3-1 Linear structure (optical)

3.2.2 Star/tree structure

Functional description

Star/tree structures can be created with IE Switches X-400. The cascading depth and total span of a network are limited only by the signal propagation times of the communication connections.

Properties of a star structure

Each IE Switch X-400 communicates over a TP or FO cable with a central switch with which all other switches are also connected within a star structure. Communication is possible over the optical or the electrical ports.

For more detailed information, refer to the table below.

Table 3- 3 Optical ports (on the slots)

Media module	SCALANCE X414-3E	SCALANCE X408-2
Gigabit MM492-2, MM492-2LD, MM492-2LH, MM492-2LH+ or MM492-2ELH	5	5 and 6
Fast Ethernet MM491-2, MM491-2LD or MM491-2LH+	6 and 7 with extender: 12, 13, 14 and 15	5 and 6

Table 3- 4 Electrical ports (on the slots)

Transmission rate	SCALANCE X414-3E	SCALANCE X408-2
Gigabit	5	5 and 6
Fast Ethernet	5 and 9 through 11 (12 and 13 with extender)	5, 6 and 8

With the fault mask, it is possible to monitor the port states using the signaling contact. In addition to connecting the switches to the central IE Switch X-400, it is also possible to connect one or more end devices.

Configuration example

Sample configurations electrical / optical with SCALANCE X-400, SCALANCE X-200, SIMATIC S7-300/400, SIMATIC ET 200, and operator panels as end devices.

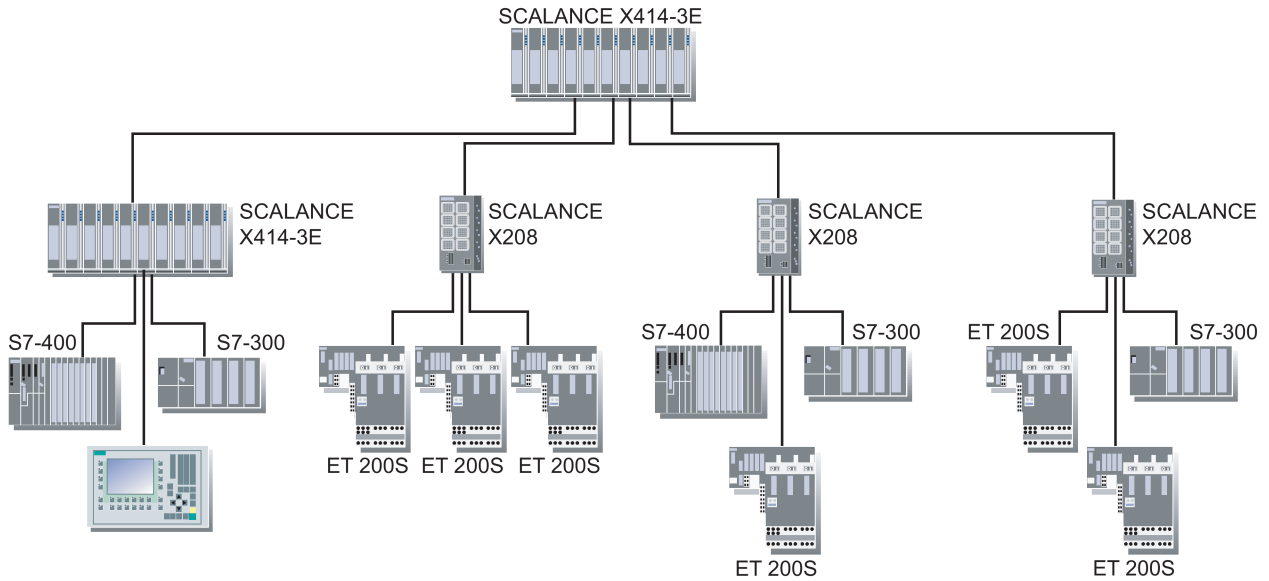

Figure 3-2 Star structure (electrical)

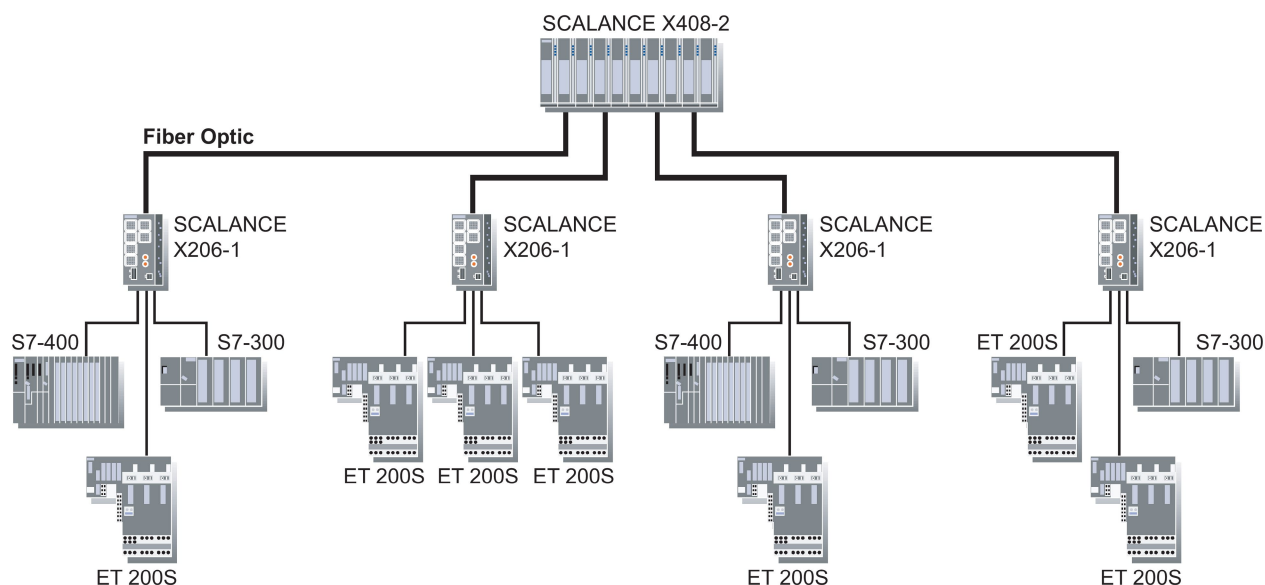

Figure 3-3 Star structure (optical)

3.2.3 Ring with redundancy manager

To increase the availability, optical or electrical linear topologies of up to 50 switches (IE Switches X-400, SCALANCE X-200, or OSM/ESM) can be closed with a SCALANCE X414-3E or SCALANCE X408-2 to form a ring.

Functional description

The two ends of the bus are closed to form a ring by an IE Switch X-400 operating as a redundancy manager.

Table 3- 5 Redundancy manager setting

SCALANCE X414-3E	SCALANCE X408-2
The redundancy manager function is enabled or disabled by DIL switches on the CPU module or by configuring with CLI or WBM.	The redundancy manager function is enabled by the SELECT/SET button or implemented by a setting in the software (CLI or WBM). For more detailed information, refer to the configuration manual "Industrial Ethernet Switches SCALANCE X-300 SCALANCE X-400".

In contrast to the ring ports of the other switches, the ring ports of the redundancy manager are disconnected when the network is operating problem-free. The IE Switch X-400 operating in the redundancy manager mode monitors the connected bus over its ring ports and switches the ring ports through if there is an interruption on the connected bus; in other

3.2 Network topologies

words, it restores a functioning bus over this substitute path. Reconfiguration is achieved within 0.3 s. As soon as the problem is eliminated, the original topology is restored; in other words, the ring ports in the redundancy manager are disconnected from each other again.

In a ring with redundancy manager, there can only be one switch configured as a redundancy manager.

(Default ports 5.1 and 5.2. Both the RM and the switches in the ring must be connected over these ring ports to allow redundancy to function.)

Electrical ring ports

An electrical ring with redundancy manager can be set up without media modules since the basic device provides connectors (RJ-45 jacks) that allow attachment of electrical (twisted pair) connections (10, 100, 1000 Mbps). The factory setting defines the two ports on slot 5 as ring ports.

Table 3- 6 Connectors of the basic device (on the slots)

SCALANCE X414-3E	SCALANCE X408-2
5	5 and 6

Optical ring ports

An optical ring with redundancy manager is only possible with media modules. Which slots or ports should be used, depends on the selected transmission rate. The ports that can be used as ring ports are located on the media modules that can be used in the following slots (see table).

As an alternative to optical gigabit transmission, the following ports (see table) can also be configured as ring ports for an optical Fast Ethernet connection.

Table 3- 7 Optical ring with redundancy manager (on the slots)

Media module	SCALANCE X414-3E	SCALANCE X408-2
Gigabit MM492-2, MM492-2LD, MM492-2LH, MM492-2LH+ or MM492-2ELH	5	5 and 6
Fast Ethernet MM491-2, MM491-2LD or MM491-2LH+	6 and 7	5 and 6

Connection of other network segments or end devices

Just as with all other switches in the ring with redundancy manager, further end devices or entire subnets can be connected to the ports listed in the table over twisted pair (TP cable).

Table 3- 8 Ports for further network segments or end devices

SCALANCE X414-3E	SCALANCE X408-2
To all ports of slots 9-11 and to the ports of a twisted pair extender module	All non ring ports

With the SCALANCE X414-3E, the use of a media module extender in the redundancy manager and in all other switches in this network structure provides the option of connecting further end devices or complete subnets with FO cable.

Configuration example

Sample configurations with SCALANCE X-400, SIMATIC S7-200/300/400, operator control and monitoring system, H system, and PC as end devices.

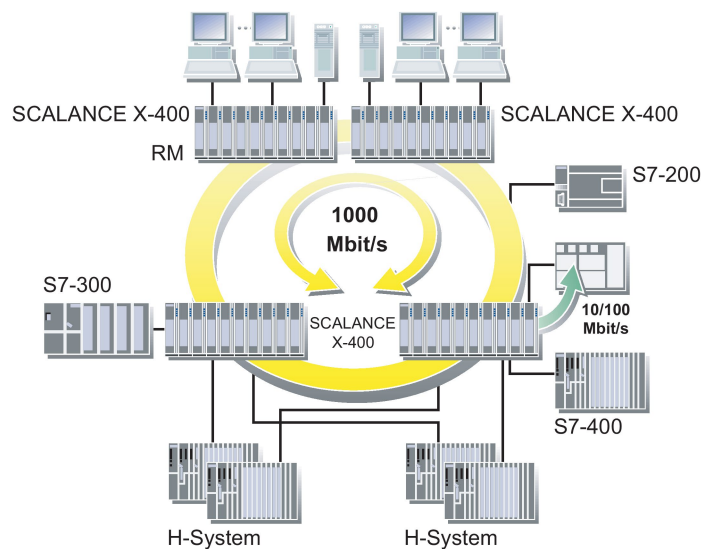

Figure 3-4 Gigabit ring with redundancy manager (RM)

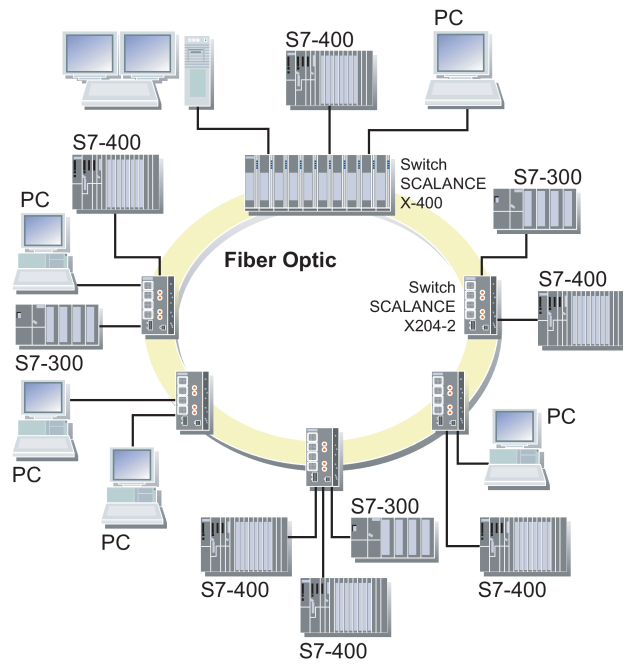

Figure 3-5 Optical ring with redundancy manager

3.2.4 Options of media redundancy

There are various options available to increase the network availability of an Industrial Ethernet network with optical or electrical linear bus topologies:

- Mesh networks
- Parallel connection of transmission paths
- Closing a linear bus topology to form a ring topology

3.2.5 Media redundancy in ring topologies

Structure of a ring topology

Nodes in a ring topology can be external switches and/or the integrated switches of communications modules.

To set up a ring topology with media redundancy, you bring together the two free ends of a linear bus topology in one device. Closing the linear bus topology to form a ring is achieved with two ports (ring ports) of a device in the ring. This device is the redundancy manager. All other devices in the ring are redundancy clients.

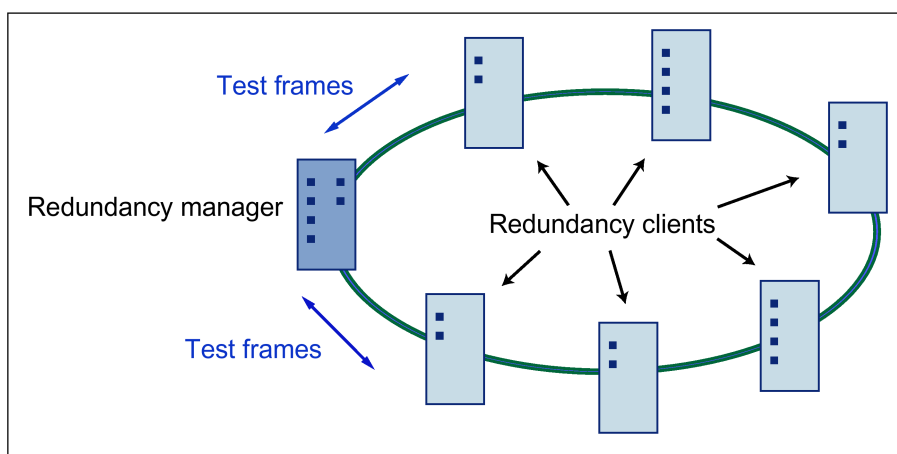

Figure 3-6 Devices in a ring topology with media redundancy

The two ring ports of a device are the ports that establish the connection to its two neighboring devices in the ring topology. The ring ports are selected and set in the configuration of the relevant device. In STEP 7 and on the S7 Ethernet CP modules themselves, the ring ports are indicated by an "R" after the port number.

Note

Before physically closing the ring, download the configuration of your STEP 7 project to the individual devices.

How media redundancy works in a ring topology

When using media redundancy, the data paths between the individual devices are reconfigured if the ring is interrupted at one point. Following reconfiguration of the topology, the devices can once again be reached in the resulting new topology.

In the redundancy manager, the 2 ring ports are disconnected from each other if the network is uninterrupted. This prevents circulating data frames. In terms of data transmission, the ring topology is a linear bus topology. The redundancy manager monitors the ring topology. It does this by sending test frames both from ring port 1 and ring port 2. The test frames run round the ring in both directions until they arrive at the other ring port of the redundancy manager.

3.2 Network topologies

An interruption of the ring can be caused by loss of the connection between two devices or by failure of a device in the ring.

If the test frames of the redundancy manager no longer arrive at the other ring port because of an interruption in the ring, the redundancy manager connects its two ring ports. This substitute path once again restores a functioning connection between all remaining devices in the form of a linear bus topology.

As soon as the interruption is eliminated, the original transmission paths are established again, the two ring ports of the redundancy manager are disconnected and the redundancy clients informed of the change. The redundancy clients then use the new paths to the other devices.

The time between the ring interruption and restoration of a functional linear topology is known as the reconfiguration time.

If the redundancy manager fails, the ring becomes a functional linear bus.

Media redundancy methods

The following media redundancy methods are supported by SIMATIC NET products:

- HRP (High Speed Redundancy Protocol)
Reconfiguration time: 0.3 seconds
- MRP (Media Redundancy Protocol)
Reconfiguration time: 0.2 seconds

The mechanisms of these methods are similar. HRP and MRP cannot be used in the ring at the same time.

3.2.6 Redundant coupling of network segments

Redundant coupling of network segments

The example of the redundant linking of two network segments shown here, for example rings with redundancy manager (HRP only), can be implemented homogeneously with SCALANCE X414-3E or SCALANCE X408-2 or mixed with SCALANCE X414-3E and SCALANCE X408-2. Reconfiguration time 300 ms.

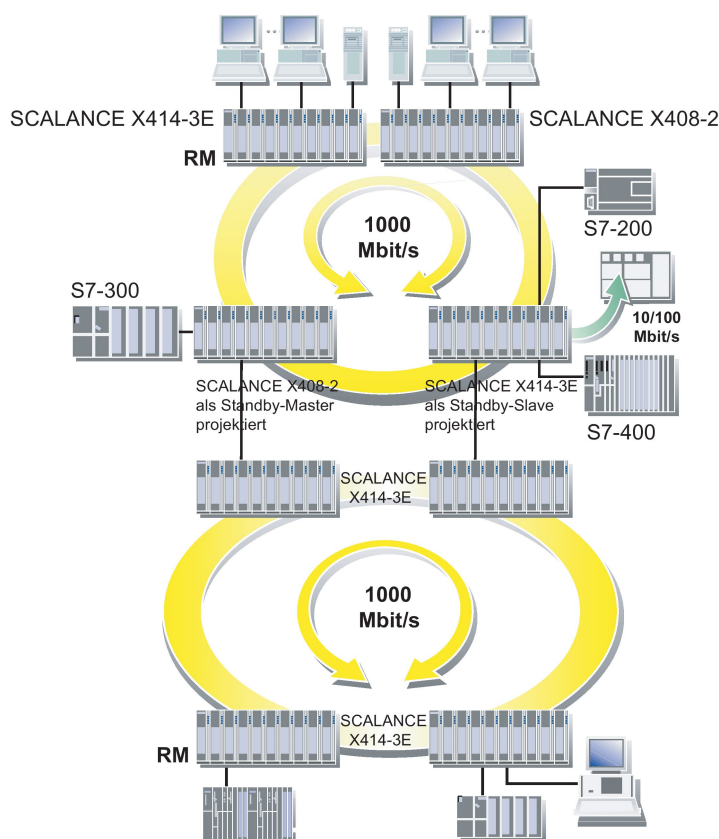

Figure 3-7 Redundant coupling of two subnets in mixed operation with SCALANCE X414-3E and SCALANCE X408-2

In this case, network segments are rings with a redundancy manager (RM). The rings can also be interrupted at one point (linear topology).

For a redundant link as shown in the figure, two devices must be configured within a network segment. This configuration is set in Web Based Management, Command Line Interface or using SNMP access. For more detailed information, refer to the configuration manual "SCALANCE X-300 and SCALANCE X-400 Industrial Ethernet Switches". The two devices connected in the configuration exchange data frames with each other to synchronize their operating statuses (one device is master and the other slave). If there are no problems, only the link from the master to the other network segment is active. If this link fails (for example

3.3 System description of SCALANCE X-400

due to a link-down or a device failure), the slave activates its link as long as the problem persists. Reconfiguration takes place within 0.3 s.

Note

If SCALANCE X408-2 are used exclusively for redundant coupling of the gigabit rings, the coupling links can also be designed with a gigabit transmission rate.

3.3 System description of SCALANCE X-400

3.3.1 Properties, functionality and features of SCALANCE X-400

This chapter explains special properties, features, and options available to you with IE Switches X-400.



The basic device always consists of the frame, the power supply and a CPU module. The basic device of the SCALANCE X414-3E has additional digital signal inputs.

IE Switches X-400 provide a modular structure for the required ports. The modularity simplifies setup and subsequent expansion of complex network topologies to meet current needs.

- **Gigabit technology**
The basic device has ports with a transmission rate of 1 Gbps for electrical cables (twisted pair) or by adding gigabit media modules for fiber-optic cables (FO).
- With IE-Switches X-400, it is possible to split the ring ports on two different slots. If one of the media modules fails, operation can be maintained as a linear bus structure. A defective module can be replaced during operation.
- The basic device has a signaling contact for local operator control.
- There is a serial interface available for local diagnostics and local configuration.
- **C-PLUG**
When replacing a device, the C-PLUG can be removed and inserted in the new device so that the configuration can be retained.

Components of the IE Switches X-400

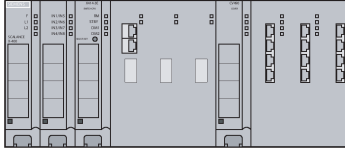
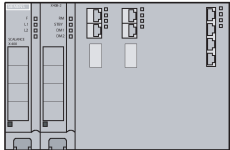
The following table shows the components of the IE Switches X-400:

Component	Function	Figure
SCALANCE X414-3E basic device	IE Switch with management functions and <ul style="list-style-type: none"> • 12 Fast Ethernet RJ-45 interfaces • 2 gigabit Ethernet RJ-45 interfaces • 1 slot for media module MM492-2, MM492-2LD, MM492-2LH, MM492-2LH+ or MM492-2ELH • 2 slots for media modules MM491-2, MM491-2LD or MM491-2LH+ • 1 x slot for extender EM495-8 or EM496-4 • 8 digital inputs • Additional Ethernet RJ-45 interface for "outband" management. • Layer 3 routing functionality 	 <p>Example SCALANCE X414-3E</p>
SCALANCE X408-2 basic device	IE Switch with management functions and <ul style="list-style-type: none"> • 4 Fast Ethernet RJ-45 interfaces • 4 gigabit Ethernet RJ-45 interfaces • 2 combined slots for media modules MM492-2, MM492-2LD, MM492-2LH, MM492-2LH+, MM492-2ELH, MM491-2, MM491-2LD or MM491-2LH+ 	 <p>Example SCALANCE X408-2</p>
Media module fiber-optic 1000 Mbps	Expands the basic device by two gigabit fiber-optic ports.	 <p>MM492-2, MM492-2LD, MM492-2LH, MM492-2LH+, MM492-2ELH</p>

3.3 System description of SCALANCE X-400

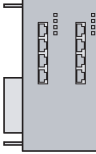
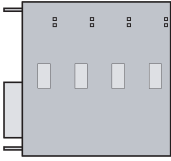
Component	Function	Figure
Media module 100 Mbps	Expands the basic device by two Fast Ethernet fiber-optic ports.	 <p>MM491-2, MM491-2LD (as of product version ES04), MM491-2LH+</p>
Only for SCALANCE X414-3E Twisted pair extender	Expands the basic device by eight Fast Ethernet ports with RJ-45 jacks.	 <p>EM495-8</p>
Only for SCALANCE X414-3E Media module extender	Expands the basic device by four slots for Fast Ethernet media modules.	 <p>EM496-4</p>

3.3.2 Ports of SCALANCE X-400

Ports

IE Switches X-400 provide you with electrical ports that can be used as gigabit and ring ports. The expansion with media modules provides you with additional optical ports.

By using an extender module, you can increase the number of ports on the SCALANCE X414-3E by a maximum of eight ports.

3.3.2.1 10Base-T / 100Base-TX

Transmission rate

The transmission rate of the electrical ports is 10 Mbps or as Fast Ethernet ports 100 Mbps.

Transmission mode

The transmission mode for 10Base-T / 100Base-TX is specified in the IEEE 802.3i / IEEE 802.3u standards of the Institute of Electrical and Electronic Engineers.

Autonegotiation (automatic detection of the best transmission modes) is default. The order in which they are selected is:

- 100Base-TX full duplex
- 100Base-TX half duplex
- 10Base-T full duplex
- 10Base-T half duplex

Two communication modes are possible:

- Half duplex
Two-way alternate transmission mode - it is only possible to either send or receive over the interfaces at any one time.
- Full duplex mode
Two-way simultaneous - both communication partners can send and receive at the same time.

Connections to other switches can use half or full duplex; connections to hubs are possible only in half duplex mode.

Transmission medium

Data transmission at 10 Mbps and at 100 Mbps is over two wire pairs (pin 1, 2, 3, 6) of the twisted pair cable. For 10 Mbps, at least a category 3 (Cat 3) and for 100 Mbps, at least a four-wire (2x2) category 5 (Cat 5) cable is necessary.

Transmission range

The maximum transmission range (segment length) is 100 m.

Connectors

The connectors used are 8-pin RJ-45 jacks with securing collars. The securing collar in conjunction with the cover ensures a flush fit and the locking mechanism with the PROFINET-compliant male connectors IE FC RJ-45 Plug 180 and IE FC_RJ-45 Plug 145 provides a rugged node attachment suitable for an industrial environment that provides strain and bending relief for the RJ-45 jack.

3.3.2.2 1000Base-T

Transmission rate

The transmission rate of the electrical gigabit ports is 1 Gbps.

Transmission mode

The transmission mode for 1000Base-T is specified in the IEEE 802.3ab standard.

At 1 Gbps, autonegotiation is optional.

Two communication modes are possible:

- Half duplex
- Full duplex

Transmission medium

Data is transmitted over an eight-wire twisted pair cable.

Note

For data transmission at 1 Gbps, at least a Cat 5e twisted-pair cable with 4 x 2 wires is necessary. With a four-wire cable (2 x 2 wires), a maximum data transmission rate of 100 Mbps is possible.

Transmission range

The maximum transmission range (segment length) is 100 m.

Connectors

The connectors used are 8-pin RJ-45 jacks.

3.3.2.3 100Base-FX

Transmission rate

The transmission rate of the optical Fast Ethernet ports is 100 Mbps.

Transmission mode

Transmission with 100Base-FX is defined in the IEEE 802.3u standard and is specified as 100 Mbps transmission rate and full duplex.

Transmission medium

Data transmission is over multimode or single mode fiber-optic cable (FOC).

Two FOC types can be used:

- Multimode FOC
The core diameter is 50 μm ; the light source is an LED. Many modes are used for signal transmission. The propagation times of the light pulses (dispersion) restrict the maximum range considerably.
- Single mode FOC
The core diameter is 9 or 10 μm ; the light source is a laser diode. To transmit a signal, only one mode is used greatly reducing dispersion. As a result, the maximum range of single mode FOC is greater than that of multimode FOC.

Regardless of the type used, the outer diameter of the FOC is 125 μm .

Transmission range

The maximum transmission range (segment length) depends on the module selected and the FOC. The range is as follows:

- 100Base-FX module and multimode FOC: 3 km
- 100Base-FX-LD module and single mode FOC: 26 km
- 100Base-FX-LH/ LH+ module and single mode FOC: 70 km

Connectors

The connectors used are BFOC sockets or SC duplex sockets with the 100BaseFX LH/ LH+ module.

3.3.2.4 1000Base-SX

Transmission rate

The transmission rate of the optical gigabit ports is 1 Gbps.

Transmission mode

Transmission with 1000Base-SX is defined in the IEEE 802.3z standard and is specified as 1000 Mbps transmission rate and full duplex.

Transmission medium

Data is transmitted over multimode FOC. The wavelength is 850 nm.

The core diameter of the multimode FOC is 50 µm; the light source is an LED. Many modes are used for signal transmission. The propagation times of the light pulses (dispersion) restrict the maximum range considerably.

Transmission range

The maximum transmission range (segment length) is 750 m when using SIMATIC NET fiber-optic multimode FOC with SC duplex connectors.

Connectors

SC duplex female connectors are used.

3.3.2.5 1000Base-LX

Transmission rate

The transmission rate of the optical gigabit ports is 1 Gbps.

Transmission mode

Transmission with 1000Base-LX is defined in the IEEE 802.3z standard and is specified as 1000 Mbps transmission rate and full duplex.

Transmission medium

Data is transmitted over single mode FOC. The wavelength is 1310 nm or 1550 nm.

The core diameter of the single mode FOC is 9 or 10 µm; the light source is a laser diode. To transmit a signal, only one mode is used greatly reducing dispersion. As a result, the maximum range of single mode FOC is greater than that of multimode FOC.

Transmission range

The maximum transmission range (segment length) is 120 km for single mode FOC.

Connectors

SC duplex female connectors are used.

3.3.3 Compatibility of SCALANCE X-400

Compatibility list

The following products and devices are compatible with IE Switches X-400:

- End devices
All SIMATIC NET products with a TP port can be connected to the ports of the IE Switches X-400.
- Network components in linear or star structure
ESM/OSM
OMC (TP cable max. 6 m long)
SCALANCE X005
SCALANCE X-100
SCALANCE X-100 medium converter
SCALANCE X-200
SCALANCE X-200IRT
SCALANCE S-600
SCALANCE W-700
- Network components in a ring structure with IE-Switches X-400 as RM
ESM/OSM
SCALANCE X-200
SCALANCE X-200IRT
- Redundant coupling of networks.
 - In the network segment with the master-slave pair to be configured:
SCALANCE X-400
 - In the network segment to be coupled:
ESM/OSM
SCALANCE X-200
SCALANCE X-200IRT
SCALANCE X-400

Note

All compatibility information assumes the correct use of the TP and FOC cables.

3.4 Description of the product

3.4.1 Product characteristics

Overview

The IE Switches X-400 consist of modular Industrial Ethernet switches, media modules, and extenders. 100 Mbps and 1000 Mbps technology is supported for different transmission media (twisted pair, fiber-optic) and increased port requirements. The main areas of application are high-performance plant networks. Due to its modular structure, the IE Switches X-400 are designed to meet future demands and can be adapted to meet the requirements of a particular task.

Table 3- 9 Overview of the product characteristics

Properties	Device type	
	X414-3E	X408-2
Diagnostics LED	+	+
2x 24 V DC	+	+
C-PLUG	+	+
Digital Inputs	+	-
Ring redundancy with RM	+ (with DIL switches or CLI / WBM)	+ (using software)
Standby link	+ (using software)	+ (using software)

Table 3- 10 Overview of the connection options

Media module	Device type	
	X414-3E	X408-2
MM491-2	2 (with extender module 6)	2
MM491-2LD	2 (with extender module 6)	2
MM491-2LH+	2 (with extender module 6)	2
MM492-2	1	2
MM492-2LD	1	2
MM492-2LH	1	2
MM492-2LH+	1	2
MM492-2ELH	1	2
EM495-8	1	-
EM496-4	1	-

3.4.2 SCALANCE X414-3E basic device

Overview

The SCALANCE X414-3E has two integrated gigabit Ethernet twisted pair ports (100 or 1000 Mbps) to interconnect multiple switches. The nodes are connected over 12 Fast Ethernet ports integrated in the switch (10 or 100 Mbps).

To set up optical gigabit networks, both integrated gigabit Ethernet ports can be converted to fiber-optic cable over a 2-port gigabit Ethernet module. Module variants for multimode (up to 750 m) and single mode (up to 70 km) are available.



Figure 3-8 Basic device without media modules, protective caps and covers

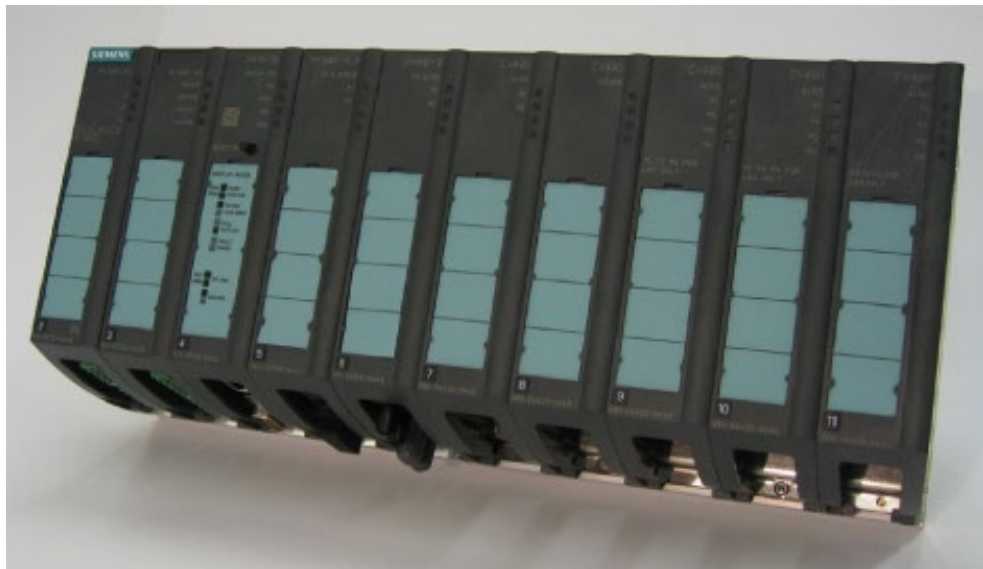

Figure 3-9 Basic device with media modules and covers

Components of the product

The following components are supplied with the SCALANCE X414-3E:

- Basic device with power module in slot 2, DI module with eight digital inputs in slot 3, CPU module including C-PLUG in slot 4, protective caps for media module terminal strips in slots 5, 6, and 7.
- 1 CV490 2x1000, cover of media module slot 5
2 CV490 2x100, cover of media module slots 6 and 7
1 CV490 Cover, dummy cover for slot 8
3 CV490 4x100, cover for slots 9 to 11
- SIMATIC NET Manual Collection CD
- Slot labels for slots 1 through 18
- 1 connector for power supply (4-pin)
- 1 connector for signaling contact (4-pin)
- 2 connectors for digital inputs (5-pin)
- 1 sheet with 15 labeling strips

Replacement parts

- 1 C-PLUG (order number: 6GK1 900-0AB00)
- Cover set CV490 (order number: 6GK5 490-0AA00-0AA2)
 - 1 cover CV490 2x1000
 - 2 covers CV490 2x100
 - 1 dummy cover CV490
 - 3 covers CV490 4x100
- Terminal set (order number: 6GK5 498-1AA00-0AA0)
 - 10 connecting terminals for power supply and signaling contact 4-pin
 - 10 connecting terminals digital inputs 5-pin
- 1 location label (order number: 6ES7 912-0AA00-0AA0)
- 10 DIN A4 sheets each with 15 labeling strips
(order number: 6GK5 498-0AA00-0AA0)

Slots

The SCALANCE X414-3E basic device consists of a backplane with three permanently installed modules in slots 2, 3, and 4.

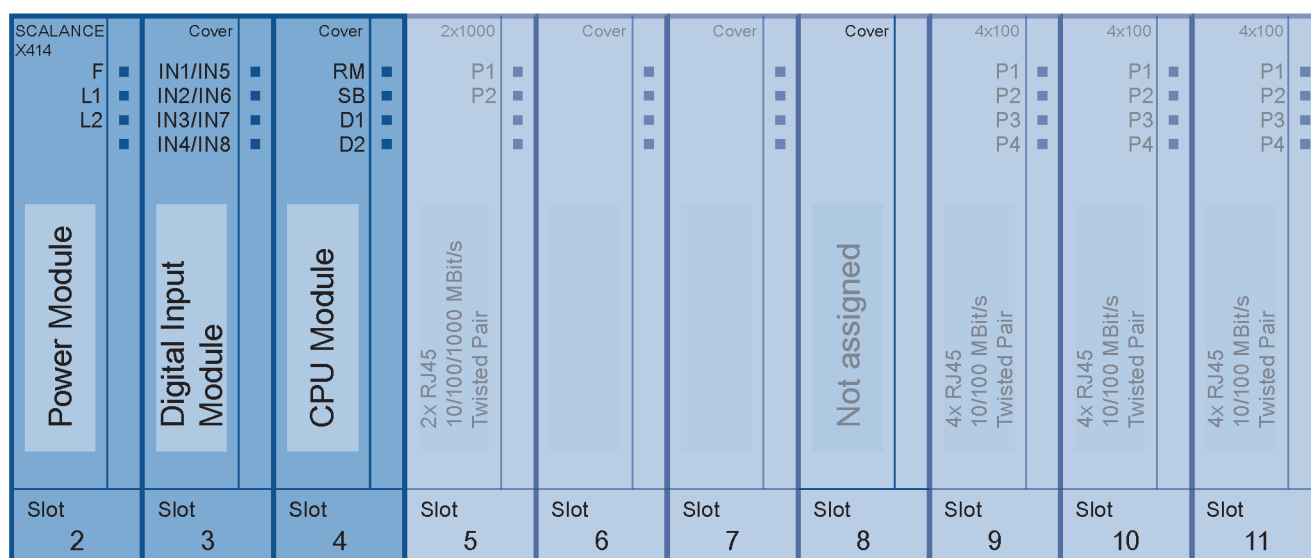

Figure 3-10 Basic device X414-3E without media modules with existing ports

The modules in the individual slots have the following interfaces or control elements (slot 1 is reserved for a power supply unit):

- Slot 2
Power module
with two 4-pin sockets for connecting a redundant power supply and for connecting the

3.4 Description of the product

signaling contact and protective earth.

The input voltage of 24 V DC is transformed to the internal supply voltage.

- Slot 3
Digital input module
with two 5-pin sockets for connecting eight digital inputs that allow different signaling modes.
- Slot 4
CPU module contains
 - the Ethernet port, only for commissioning and configuration of the X414-3E.
 - the serial RS-232 port for firmware update or management over the Command Line Interface (CLI).
 - the C-PLUG for storage of parameter assignments.
 - the DIL switch for the redundancy manager function and to specify the ring ports.
 - the SELECT/SET button for device display and configuration.
 - the LED display for redundancy manager and standby mode as well as display modes Dmode A through Dmode D.
- Slot 5
Contains two RJ-45 jacks allowing attachment of electrical (twisted pair) connections (10, 100, 1000 Mbps). As an option, slot 5 allows the use of an optical gigabit module with two ports (1000Base-SX or 1000Base-LX).
- Slots 6 and 7
Optional use of two optical Fast Ethernet modules (100 Mbps) each with two ports (100Base-FX).
- Slot 8
No function in system.
- Slot 9 through 11
Each contains four RJ-45 jacks allowing attachment of 12 electrical (twisted pair) connections in total (10, 100 Mbps). These cannot be used by media modules.

3.4.2.1 SCALANCE X414-3E power module

The power module is located in slot 2.

The power module can be supplied with power redundantly over two inputs. The two power inputs are isolated from each other, there is no power distribution. If redundant power feed-in is used, the switch is supplied solely by the section of the power module with the higher output voltage.

The front 4-pin connector is used for the power supply. The input voltage is 24 V DC (20.4 – 28.8 V). The signaling contact supplies the fault status at the rear 4-pin connector. If there is a fault, the contact opens.

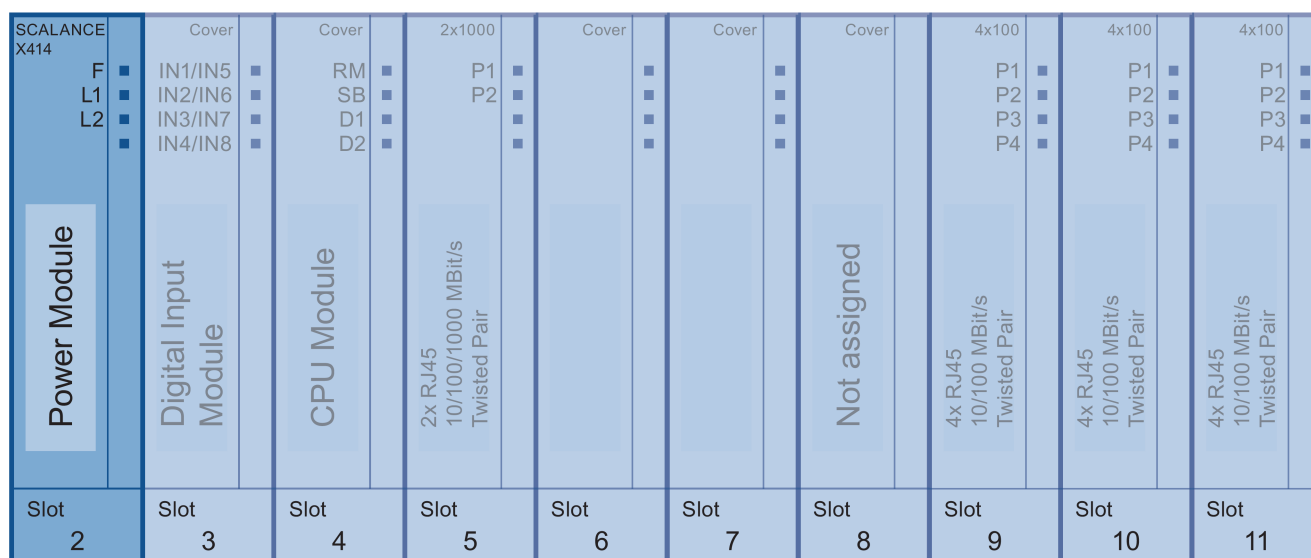

Figure 3-11 Slot of the power module

Signaling contact

The following can be signaled over a floating signaling contact:

- Power failure.
The power supply monitored is selected in the fault mask.
- Bad link status of a port.
(Bad connector or no connection to partner device). The port monitored is selected in the fault mask.
- Change to the DIL switch during operation.
Possible inconsistency between the switch setting and the actual operating state, The switch setting is adopted only after a restart.

If the SCALANCE X414-3E is set as the redundancy manager, the following errors are also reported:

- Bad link status of the ring ports, regardless of the status of the fault mask.
- Configuration of a second IE Switch X-400 as redundancy manager in the same ring.

3.4 Description of the product

3.4.2.2 SCALANCE X414-3E digital inputs

DI module

The digital input module is located in slot 3 and provides the user with eight digital inputs. The cables are connected to the bottom of the module by two 5-pin connectors.

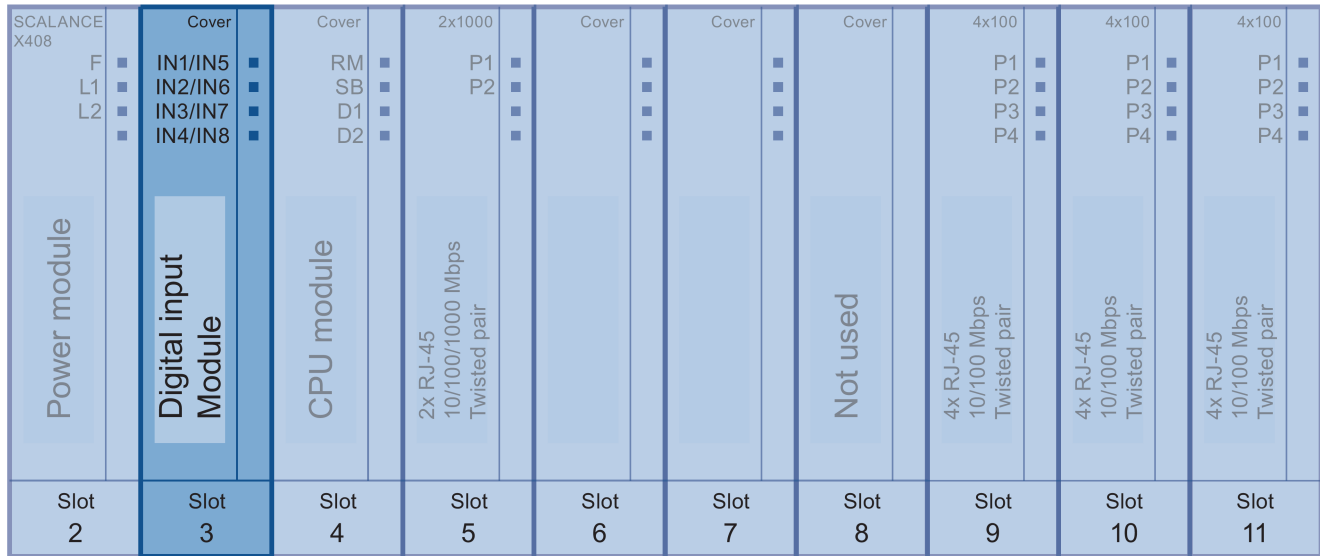

Figure 3-12 LEDs of the digital input mode

Depending on the configuration, the states of the digital inputs can be used to send E-mails and/or entries to the logbook of the SCALANCE X414-3E.

It is also possible to read the statuses over SNMP.

3.4.2.3 SCALANCE X414-3E switch functionality

CPU module

The CPU module is in slot 4.

There are four DIL switches on the CPU module with which the switch can be configured.

This module also has four LEDs for displaying parameter assignments that can be modified by the user with the DIL switch and a SELECT / SET button.

SCALANCE X414	Cover	Cover	2x1000	Cover	Cover	Cover	4x100	4x100	4x100
F ■	IN1/IN5 ■	RM ■	P1 ■	■	■	■	P1 ■	P1 ■	P1 ■
L1 ■	IN2/IN6 ■	SB ■	P2 ■	■	■	■	P2 ■	P2 ■	P2 ■
L2 ■	IN3/IN7 ■	D1 ■	■	■	■	■	P3 ■	P3 ■	P3 ■
■	IN4/IN8 ■	D2 ■	■	■	■	■	P4 ■	P4 ■	P4 ■
Power Module	Digital Input Module	CPU Module	2x RJ45 10/100/1000 MBit/s Twisted Pair			Not assigned	4x RJ45 10/100 MBit/s Twisted Pair	4x RJ45 10/100 MBit/s Twisted Pair	4x RJ45 10/100 MBit/s Twisted Pair
Slot 2	Slot 3	Slot 4	Slot 5	Slot 6	Slot 7	Slot 8	Slot 9	Slot 10	Slot 11

Figure 3-13 Slot of the CPU module

Serial port

The CPU module of the SCALANCE X414-3E has an RS-232 port.

This is used for the following purposes:

- Firmware updates
- Management with the aid of the command interpreter (Command Line Interpreter, CLI) including setting of the IP address information.

Input to the command interpreter is over command lines.

For more detailed information, refer to the configuration manual "SCALANCE X-300 SCALANCE X-400 Industrial Ethernet Switches".

3.4 Description of the product

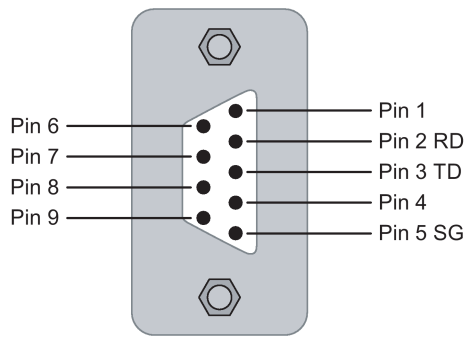

Figure 3-14 Pin assignment

Ethernet port

On the bottom panel of the CPU module of the SCALANCE X414-3E, there is an 8-pin RJ-45 jack. This Ethernet interface can be used for productive communication with other switches or end devices. This is used for the following purposes:

- Configuration
- Commissioning

The SCALANCE X414-3E can be configured either locally or over a network.

For more detailed information, refer to the configuration manual "SCALANCE X-300 SCALANCE X-400 Industrial Ethernet Switches".

3.4.2.4 SCALANCE X414-3E ports

Ports

The basic version of the SCALANCE X414-3E without expansion with media modules provides 14 ports.

It provides two gigabit ports on slot 5 and four Fast Ethernet ports on each of slots 9 through 11.

The two ports on slot 5 can be used as ring ports (default setting).

By inserting media modules in slots 6 and 7, you have 4 further optical ports available either as ring ports or as end device ports.

By docking an extender module to the right of slot 11, you can extend the basic device by a further 8 ports. There are extender types available for twisted pair ports and for fiber-optic ports. The twisted pair extender is double the width of a media module and the media module extender is four times the width.

SCALANCE X414	Cover	Cover	2x1000	Cover	Cover	Cover	4x100	4x100	4x100
F	IN1/IN5	RM	P1				P1	P1	P1
L1	IN2/IN6	SB	P2				P2	P2	P2
L2	IN3/IN7	D1					P3	P3	P3
	IN4/IN8	D2					P4	P4	P4
Power Module	Digital Input Module	CPU Module	2x RJ45 10/100/1000 MBit/s Twisted Pair			Not assigned	4x RJ45 10/100 MBit/s Twisted Pair	4x RJ45 10/100 MBit/s Twisted Pair	4x RJ45 10/100 MBit/s Twisted Pair
Slot 2	Slot 3	Slot 4	Slot 5	Slot 6	Slot 7	Slot 8	Slot 9	Slot 10	Slot 11

Figure 3-15 Ports on the device

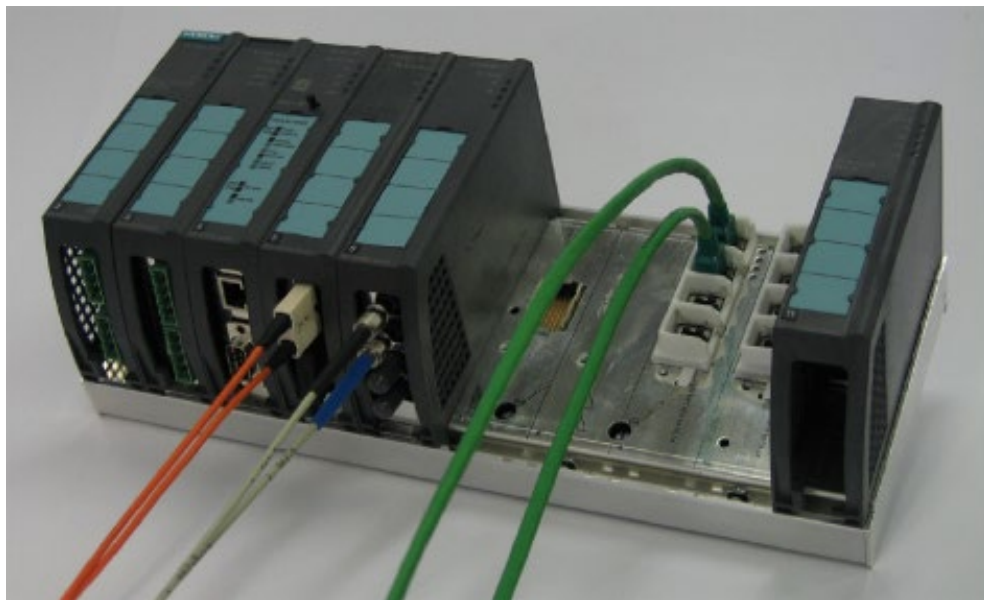

Figure 3-16 Basic device with gigabit fiber-optic cable and Fast Ethernet twisted-pair cable

3.4.3 SCALANCE X408-2 basic device

Overview

The SCALANCE X408-2 has four integrated gigabit Ethernet twisted-pair interfaces (10, 100 or 1000 Mbps) to interconnect multiple switches and to connect end devices. Further nodes are connected over four Fast Ethernet ports integrated in the switch (10 or 100 Mbps).

To set up optical gigabit networks, the integrated gigabit Ethernet ports can be converted to fiber-optic cable over 2-port gigabit Ethernet media modules. Media module variants for multimode (up to 750 m) and single mode (up to 120 km) are available.

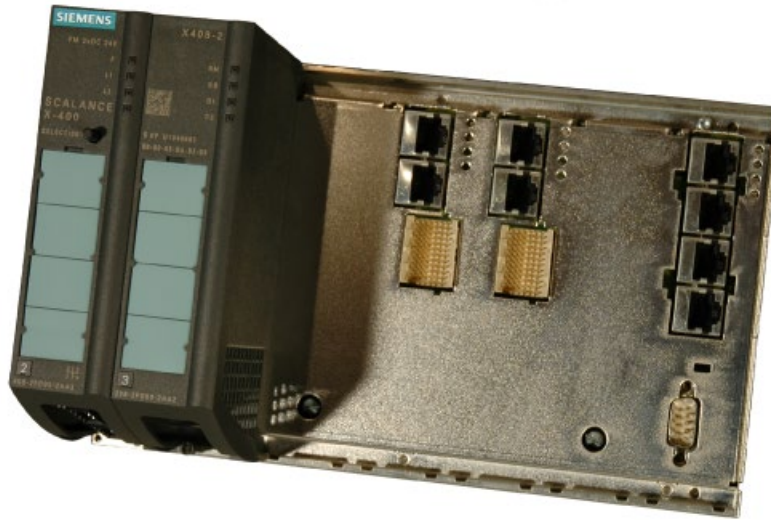

Figure 3-17 SCALANCE X408-2 basic device without media modules, protective caps and covers



Figure 3-18 SCALANCE X408-2 basic device with media modules and covers

Components of the product

The following components are supplied with the SCALANCE X408-2:

- Basic device with power module, CPU module including C-PLUG on slots 2 and 3.
Covers for media module terminal strips on slots 5 and 6.
- 2 CV490 2x1000, covers of the media module slots 5 and 6
2 CV490 cover, dummy covers for slots 4 and 7
1 CV490 4x100, cover for slot 8
- SIMATIC NET Manual Collection CD
- Slot labels for slots 1 through 8
- 1 connector for power supply (4-pin)
- 1 connector for signaling contact (4-pin)
- 1 sheet with 15 labeling strips

Replacement parts

- 1 C-PLUG (order number: 6GK1 900-0AB00)
- Cover set CV490 (order number: 6GK5 490-0AA00-0AA2)
 - 1 cover CV490 2x1000
 - 2 covers CV490 2x100
 - 1 dummy cover CV490
 - 3 covers CV490 4x100
- Terminal set (order number: 6GK5 498-1AA00-0AA0)
 - 10 connecting terminals for power supply and signaling contact 4-pin
 - 10 connecting terminals digital inputs 5-pin
- 1 location label (order number: 6ES7 912-0AA00-0AA0)
- 10 DIN A4 sheets each with 15 labeling strips
(Order number: 6GK5 498-0AA00-0AA0)

Slots

The SCALANCE X408-2 basic device comprises a backplane with two fixed modules in slots 2 and 3.

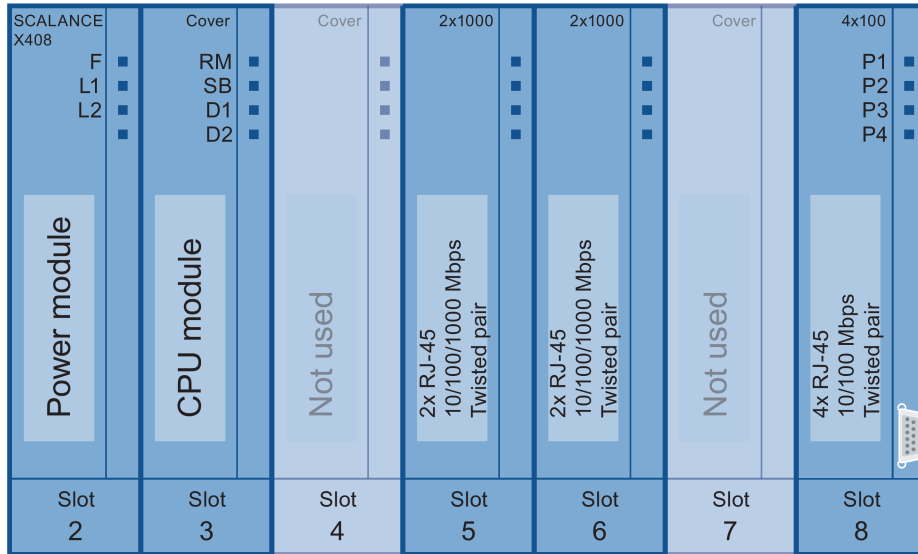

Figure 3-19 Basic device X408-2 without media modules with existing ports

The modules in the individual slots have the following interfaces or control elements (slot 1 is reserved for a power supply unit):

- Slot 2 of the power module
 - with two 4-pin sockets for connecting a redundant power supply and for connecting the signaling contact and protective earth. The input voltage of 24 V DC is transformed to the internal supply voltage.
 - A C-PLUG for storage of parameter assignments.
 - A SELECT/SET button for device display and configuration.
- Slot 3
CPU module contains the LED display for redundancy manager and standby display as well as the display modes DMode A through DMode D.
- Slot 4
No function in system.
- Slots 5 and 6
Both contain two RJ-45 jacks allowing attachment of electrical (twisted pair) connections (10, 100, 1000 Mbps).
As an option (as of product version ES 04), slots 5 and 6 allow the use of any media module (1000Base-SX or 1000Base-LX; 100Base-FX; optical gigabit module with two ports).

- Slot 7
No function in system.
- Slot 8
 - Contains four RJ-45 jacks allowing attachment of 4 electrical (twisted pair) connections (10, 100 Mbps). These cannot be used by media modules. It also includes one D-sub socket.
 - A serial RS-323 port for firmware update or management over the Command Line Interface (CLI).

3.4.3.1 SCALANCE X408-2 power module

Introduction

The power module is located in slot 2.

The power module can be supplied with power redundantly over two inputs.

The two power inputs are isolated from each other, there is no power distribution.

If redundant power feed-in is used, the switch is supplied solely by the section of the power module with the higher output voltage.

The front 4-pin connector is used for the power supply. The input voltage is 24 V DC (20.4 – 28.8 V). The signaling contact supplies the fault status at the rear 4-pin connector. If there is a fault, the contact opens.

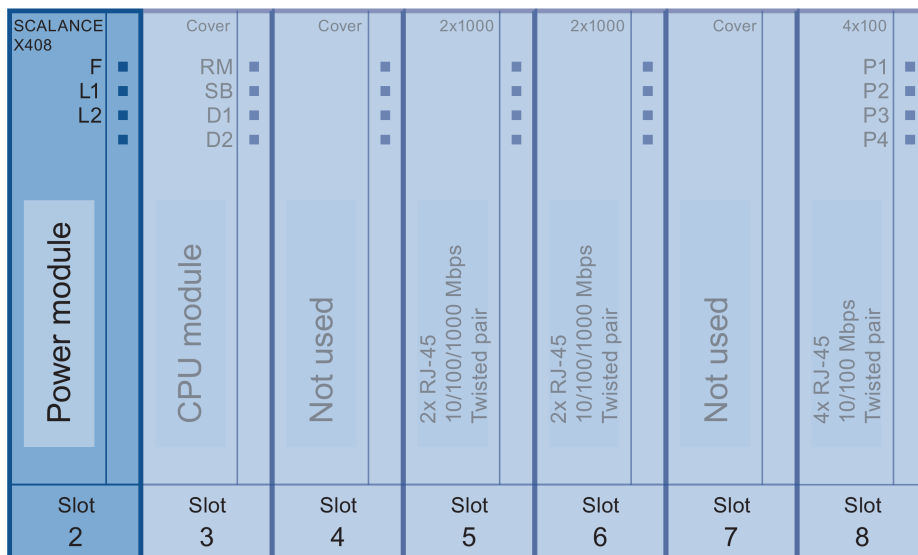

Figure 3-20 Slot of the power module

Signaling contact

The following can be signaled over a floating signaling contact:

- Power failure.
The power supply monitored (L1/L2) is selected in the fault mask.
- Bad link status of a port.
(Bad connector or no connection to partner device). The port monitored is selected in the fault mask.

If the SCALANCE X408-2 is set as the redundancy manager, the following errors are also reported:

- Bad link status of the ring ports, regardless of the status of the fault mask.
- A second IE Switch X-400 is configured as redundancy manager in the same ring.

3.4.3.2 SCALANCE X408-2 switch functionality

CPU module

Slot 3 symbolizes the CPU module.

This module has four LEDs for displaying parameter assignments that can be modified by the user with software and a SELECT/SET button.

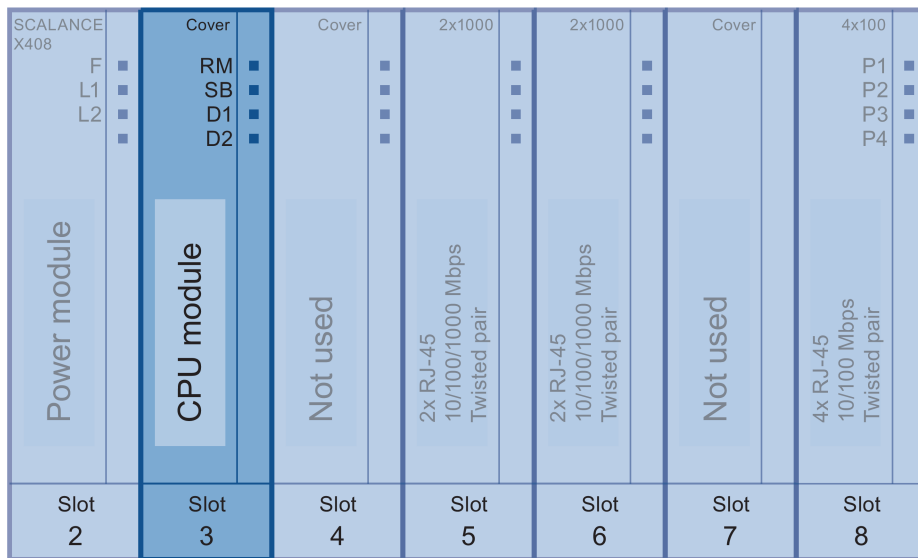

Figure 3-21 LEDs on slot 3

Serial port

The SCALANCE X408-2 has an RS-232 port. This is located on slot 8.

This is used for the following purposes:

- Firmware updates
- Management with the aid of the command interpreter (Command Line Interpreter, CLI) including setting of the IP address information.

Input to the command interpreter is over command lines.

For more detailed information, refer to the configuration manual "SCALANCE X-300 SCALANCE X-400 Industrial Ethernet Switches".

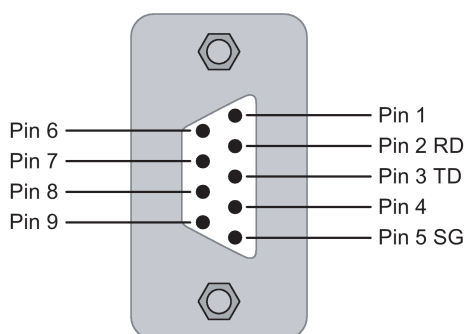

Figure 3-22 Pin assignment of the serial interface

3.4.3.3 SCALANCE X408-2 ports

Ports

The SCALANCE X408-2 provides two gigabit ports on both slot 5 and slot 6 and four Fast Ethernet ports on slot 8. The ports on slots 5 and 6 can be used as ring ports. The two ring ports can be either ports 5.1 and 5.2 (default setting) or ports 5.1 and 6.1 (can be adapted in the software).

By inserting media modules in slots 5 and 6, the four ports can be converted to optical Fast Ethernet or gigabit Ethernet ports that are therefore available as optional ring ports or end device ports.

3.4 Description of the product

SCALANCE X408	Cover	Cover	2x1000	2x1000	Cover	4x100
F ■ L1 ■ L2 ■	RM ■ SB ■ D1 ■ D2 ■	■ ■ ■ ■	■ ■ ■ ■	■ ■ ■ ■	■ ■ ■ ■	P1 ■ P2 ■ P3 ■ P4 ■
Power module	CPU module	Not used	2x RJ-45 10/100/1000 Mbps Twisted pair	2x RJ-45 10/100/1000 Mbps Twisted pair	Not used	4x RJ-45 10/100 Mbps Twisted pair
Slot 2	Slot 3	Slot 4	Slot 5	Slot 6	Slot 7	Slot 8

Figure 3-23 Ports on the basic device



Figure 3-24 Basic device with gigabit cable and Fast Ethernet twisted-pair cable

3.4.4 X-400 media modules

3.4.4.1 Overview of the media modules for SCALANCE X-400

Available module types

Note**Expanded temperature range**

To find out the product version as of which the media modules can be used for the expanded temperature range (-40°C to +70°C), refer to the section on technical specifications.

The following media modules are available to expand the basic devices:

- MM491-2 (100 Mbps)
order number: 6GK5 491-2AB00-8AA2

Note

This media module can be used as of product version 04 of the SCALANCE X408-2.

- MM491-2LD (100 Mbps)
order number: 6GK5 491-2AC00-8AA2

Note

This media module can be used as of product version 04 of the SCALANCE X408-2.

- MM491-2LH+ (100 Mbps)
order number: 6GK5 491-2AE00-8AA2

Note

This media module can be used with the SCALANCE X414-3 as of product version 05.

This media module is recognized by the SCALANCE X414-3E and SCALANCE X408-2 only as of firmware version 2.2.0.

- MM492-2 (1000 Mbps)
order number: 6GK5 492-2AL00-8AA2
- MM492-2LD (1000 Mbps)
order number: 6GK5 492-2AM00-8AA2

3.4 Description of the product

- MM492-2LH (1000 Mbps)
order number: 6GK5 492-2AN00-8AA2

Note

This media module can be used with the SCALANCE X414-3 as of product version 05.

This media module is recognized by the SCALANCE X414-3E and SCALANCE X408-2 only as of firmware version 2.2.0.

- MM492-2LH+ (1000 Mbps)
order number: 6GK5 492-2AP00-8AA2

Note

This media module can be used with the SCALANCE X414-3 as of product version 05.

This media module is recognized by the SCALANCE X414-3E and SCALANCE X408-2 only as of firmware version 2.2.0.

- MM492-2ELH (1000 Mbps)
order number: 6GK5 492-2AQ00-8AA2

Note

This media module can be used with the SCALANCE X414-3 as of product version 05.

This media module is recognized by the SCALANCE X414-3E and SCALANCE X408-2 only as of firmware version 3.0.

SCALANCE X414-3E

By using media modules, you can increase the number of available ports in the basic device SCALANCE X414-3E from 14 to 18. Four Fast Ethernet fiber-optic ports are available at the same time on slots 6 and 7. On slot 5, two gigabit fiber-optic ports are also possible instead of TP cable.

SCALANCE X408-2

The use of media modules does not change the number of available ports in the SCALANCE X408-2 basic device. On 4 ports, data transmission is also possible over fiber-optic cable instead of TP cable.

Module type	Procedure	Cabling	Connector	Segment length	Wavelength
MM491-2	100Base-FX	Multimode	BFOC	3 km	1310 nm
MM491-2LD	100Base-FX	Single mode	BFOC	26 km	1310 nm
MM491-2LH+	100Base-FX	Single mode	SC duplex	70 km	1550 nm
MM492-2	1000Base-SX	Multimode	SC duplex	750 m	850 nm
MM492-2LD	1000Base-LX	Single mode	SC duplex	10 km	1310 nm
MM492-2LH	1000Base-LX	Single mode	SC duplex	40 km	1550 nm
MM492-2LH+	1000Base-LX	Single mode	SC duplex	70 km	1550 nm
MM492-2ELH	1000Base-LX	Single mode	SC duplex	120 km	1550 nm

Note

It is possible to insert and remove the media modules during operation. Before inserting a media module, remove the cover and protective cap from the port. Please put these away for safe keeping. If you remove a media module, close the terminal strip with the protective cap and the slot with the cover.

Options for slot 5 (SCALANCE X414-3E)

Slot 5 of the basic device has two RJ-45 jacks for connecting TP cables. The possible data transmission rates on electrical connections are 10, 100, or 1000 Mbps.

An optical gigabit module in slot 5 allows data transmission with multimode or single mode FOC. In this case, the two RJ-45 jacks can no longer be used.

Options for slots 6 and 7 (SCALANCE X414-3E)

Slots 6 and 7 do not have any ports but allow two optical Fast Ethernet modules to be inserted each with ports. This gives you the opportunity of data transmission at a data transmission rate of 100 Mbps over multimode or single mode FOC.

SCALANCE X408	Cover	Cover	2x1000	Cover	Cover	Cover	4x100	4x100	4x100
F	IN1/IN5	RM	P1	P1	P1		P1	P1	P1
L1	IN2/IN6	SB	P2	P2	P2		P2	P2	P2
L2	IN3/IN7	D1					P3	P3	P3
	IN4/IN8	D2					P4	P4	P4
Power module	Digital input Module	CPU module	2x RJ-45 10/100/1000 Mbps Twisted pair			Not used	4x RJ-45 10/100 Mbps Twisted pair	4x RJ-45 10/100 Mbps Twisted pair	4x RJ-45 10/100 Mbps Twisted pair
Slot 2	Slot 3	Slot 4	Slot 5	Slot 6	Slot 7	Slot 8	Slot 9	Slot 10	Slot 11

Figure 3-25 Slots of the media modules

Options for slots 5 and 6 (SCALANCE X408-2)

Slots 5 and 6 of the basic device each have two RJ-45 jacks for connecting TP cables. The possible data transmission rates on electrical connections are 10, 100, or 1000 Mbps. An optical gigabit or Fast Ethernet module in slot 5 and/or 6 allows data transmission with multimode or single mode FOC. In this case, the two RJ-45 jacks below the module can no longer be used.

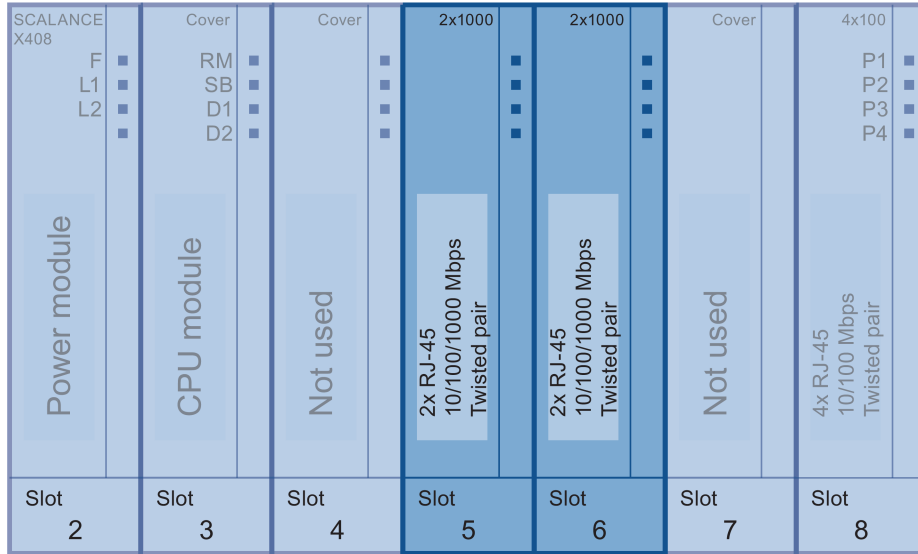

Figure 3-26 Slots of the media modules

LED display of the FO media modules

The LED displays of a module are the same as the LEDs of the basic device. With optical transmission, only a fixed transmission rate and full duplex mode are possible. The display in display modes B and C is analogous.

- In display mode A, the current connection status is displayed.
- In display mode B, the fixed transmission rate is displayed.
- In display mode C, the full duplex mode is always displayed.
- In display mode D, you can see whether or not the port is monitored.

3.4.4.2 Fast Ethernet media module MM491-2 (100Base-FX)

Introduction

- SCALANCE X414-3E
The Fast Ethernet media module MM491-2 can be used optionally in slots 6 and 7 and when using the media module extender EM496-4, it can also be used in slots 12 through 15. Mixed operation with the Fast Ethernet media modules MM491-2LD and MM491-2LH+ is possible.
- SCALANCE X408-2
As an option, the Fast Ethernet media module MM491-2 can be used in slots 5 and 6 of the basic device. Mixed operation with the Fast Ethernet media modules MM491-2LD and MM491-2LH+ and the gigabit Ethernet media modules MM492-2LD, MM492-2LH, MM492-2LH+ and MM492-2ELH is possible.

Note

The Fast Ethernet media module MM491-2 can only be used with the SCALANCE X408-2 as of product version 04.

Properties

The Fast Ethernet media module provides two ports for connecting the multimode FOC. Both ports of the module can be configured as ring ports. The signal is transmitted by LED with a wavelength of 1310 nm. The maximum cable length is 3 km.

Connector

The connectors are 2x2 BFOC sockets.

3.4.4.3 Fast Ethernet media module MM491-2LD (100Base-FX)

Introduction

- SCALANCE X414-3E
The Fast Ethernet media module MM491-2 LD can be used optionally in slots 6 and 7 of the basic device and when using the media module extender EM496-4, it can also be used in slots 12 through 15. Mixed operation with the Fast Ethernet media modules MM491-2 and MM491-2LH+ is possible.
- SCALANCE X408-2
As an option, the Fast Ethernet MM491-2 LD media module can be used in slots 5 and 6 of the basic device. Mixed operation with the Fast Ethernet media modules MM491-2 and MM491-2LH+ and the gigabit Ethernet media modules MM492-2LD, MM492-2LH, MM492-2LH+ and MM492-2ELH is possible.

Note

The Fast Ethernet media module MM491-2LD can only be used with the SCALANCE X408-2 as of product version 04.

Properties

The Fast Ethernet media module provides two ports for connecting the single mode FOC. Both ports of the module can be configured as ring ports. The signals are transmitted with a laser diode at a wavelength of 1310 nm. The maximum cable length is 26 km.

Connector

The connectors are 2x2 BFOC sockets.

3.4.4.4 Fast Ethernet media module MM491-2LH+ (100Base-FX)

Introduction

- SCALANCE X414-3E
The Fast Ethernet media module MM491-2LH+ can be used optionally in slots 6 and 7 of the basic device and when using the media module extender EM496-4, it can also be used in slots 12 through 15. Mixed operation with the Fast Ethernet media modules MM491-2 and MM491-2LH+ and the gigabit media modules MM492 is possible.
- SCALANCE X408-2
As an option, the Fast Ethernet MM491-2LH+ media module can be used in slots 5 and 6 of the basic device. Mixed operation with the Fast Ethernet media modules MM491-2 and MM491-2LD and the gigabit Ethernet media modules MM492-2LD, MM492-2LH, MM492-2LH+ and MM492-2ELH is possible.

Note

This media module can be used as of product version 05 of the SCALANCE X414-3.

This media module is recognized by the SCALANCE X414-3E and SCALANCE X408-2 only as of firmware version 2.2.0

Properties

The Fast Ethernet media module provides two ports for connecting the single mode FOC. Both ports of the module can be configured as ring ports. The signals are transmitted with a DFB laser diode at a wavelength of 1550 nm. The maximum cable length is 70 km.

Connector

SC duplex female connectors are used.

3.4.4.5 Gigabit media module MM492-2 (1000Base-SX)

Introduction

- SCALANCE X414-3E
The MM492-2 gigabit media module can be inserted as an option in slot 5.
- SCALANCE X408-2
The MM492-2 gigabit media module can be inserted as an option in slots 5 and 6. Mixed operation with the gigabit Ethernet media modules MM492-2LD, MM492-2LH, MM492-2LH+ and MM492-2ELH and the Fast Ethernet media modules MM491-2, MM491-2LD and MM491 2LH+ is possible.

3.4 Description of the product

Properties

The gigabit media module provides two ports for connecting the multimode FOC. The signal is transmitted by LED with a wavelength of 850 nm. Both ports of the module can be configured as ring ports. The maximum cable length is 750 m when using SIMATIC NET fiber-optic cables.

Connector

SC duplex female connectors are used.

3.4.4.6 Gigabit media module MM492-2 LD (1000Base-LX)

Introduction

- SCALANCE X414-3E
The MM492-2LD gigabit media module can be inserted as an option in slot 5.
- SCALANCE X408-2
The MM492-2LD gigabit media module can be inserted as an option in slots 5 and 6. Mixed operation with the gigabit Ethernet media modules MM492-2, MM492-2LH, MM492-2LH+ and MM492-2ELH and the Fast Ethernet media modules MM491-2, MM491-2LD and MM491 2LH+ is possible.

Properties

The media module provides two ports for connecting the single mode FOC. The signals are transmitted with a laser diode at a wavelength of 1310 nm. Both ports of the module can be configured as ring ports. The maximum cable length is 10 km when using SIMATIC NET fiber-optic cables.

Connector

SC duplex female connectors are used.

3.4.4.7 Gigabit media module MM492-2LH (1000Base-LX)

Introduction

- SCALANCE X414-3E
The MM492-2LH gigabit media module can be inserted as an option in slot 5.
- SCALANCE X408-2
The MM492-2LH gigabit media module can be inserted as an option in slots 5 and 6. Mixed operation with the gigabit Ethernet media modules MM492-2, MM492-2LD, MM492-2LH+ and MM492-2ELH and the Fast Ethernet media modules MM491-2, MM491-2LD and MM491-2LH+ is possible.

Note

This media module can be used as of product version 05 of the SCALANCE X414-3.

This media module is recognized by the SCALANCE X414-3E and SCALANCE X408-2 only as of firmware version 2.2.0

Properties

The media module provides two ports for connecting the single mode FOC. The signals are transmitted with a DFB laser diode at a wavelength of 1550 nm. Both ports of the module can be configured as ring ports. The max. line length is 40 km.

Connector

SC duplex female connectors are used.

3.4.4.8 Gigabit media module MM492-2LH+ (1000Base-LX)

Introduction

- SCALANCE X414-3E
The MM492-2LH+ gigabit media module can be inserted as an option in slot 5.
- SCALANCE X408-2
The MM492-2LH+ gigabit media module can be inserted as an option in slots 5 and 6. Mixed operation with the gigabit Ethernet media modules MM492-2, MM492-2LD, MM492-2LH and MM492-2ELH and the Fast Ethernet media modules MM491-2, MM491-2LD and MM491-2LH+ is possible.

Note

This media module can be used as of product version 05 of the SCALANCE X414-3.

This media module is recognized by the SCALANCE X414-3E and SCALANCE X408-2 only as of firmware version 2.2.0

3.4 Description of the product

Properties

The media module provides two ports for connecting the single mode FOC. The signals are transmitted with a DFB laser diode at a wavelength of 1550 nm. Both ports of the module can be configured as ring ports. The max. line length is 70 km.

Connector

SC duplex female connectors are used.

3.4.4.9 Gigabit media module MM492-2ELH (1000Base-LX)

Introduction

- SCALANCE X414-3E
The MM492-2ELH gigabit media module can be inserted as an option in slot 5.
- SCALANCE X408-2
The MM492-2ELH gigabit media module can be inserted as an option in slots 5 and 6. Mixed operation with the gigabit Ethernet media modules MM492-2, MM492-2LD; MM492-2LH and MM492-2LH+ and the Fast Ethernet media modules MM491-2, MM491-2LD and MM491-2LH+ is possible.

Note

This media module can be used as of product version 05 of the SCALANCE X414-3.

This media module is recognized by the SCALANCE X414-3E and SCALANCE X408-2 only as of firmware version 3.0

Properties

The media module provides two ports for connecting the single mode FOC. The signals are transmitted with a DFB laser diode at a wavelength of 1550 nm. Both ports of the module can be configured as ring ports. The max. line length is 120 km.

Connector

SC duplex female connectors are used.

3.4.5 SCALANCE X414-3E extender modules

3.4.5.1 Extender for twisted pair EM495-8

Eight additional 100Base-TX ports

Note

The EM495-8 extender module can be used only in connection with the SCALANCE X414-3E.

The SCALANCE X408-2 has no port for an extender module.

The extender module for twisted pair transmission provides an additional eight ports for connecting twisted pair cables. The TP cable is attached to an 8-pin RJ-45 jack with securing collar.

Note

The twisted pair extender CANNOT be installed during operation.

The transmission rate of the Ethernet ports is 10 Mbps or as a Fast Ethernet port 100 Mbps. No media module is required for data transfer with this extender module.

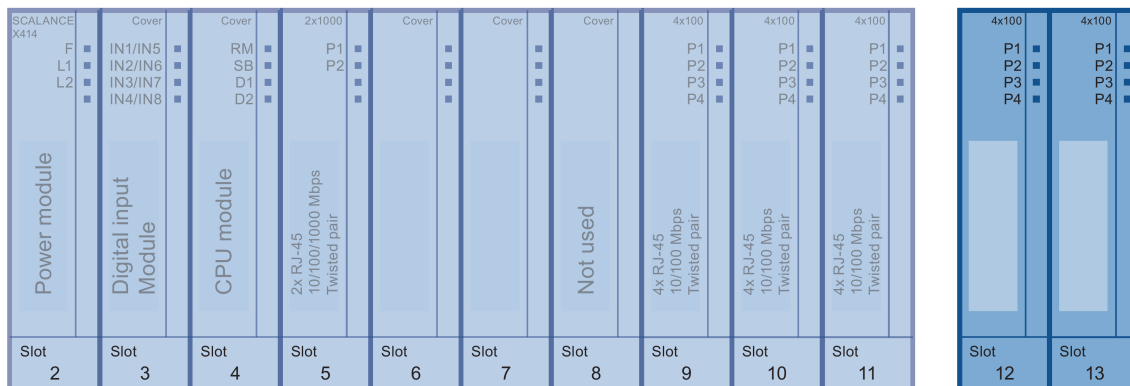

Figure 3-27 Basic device with twisted pair extender module

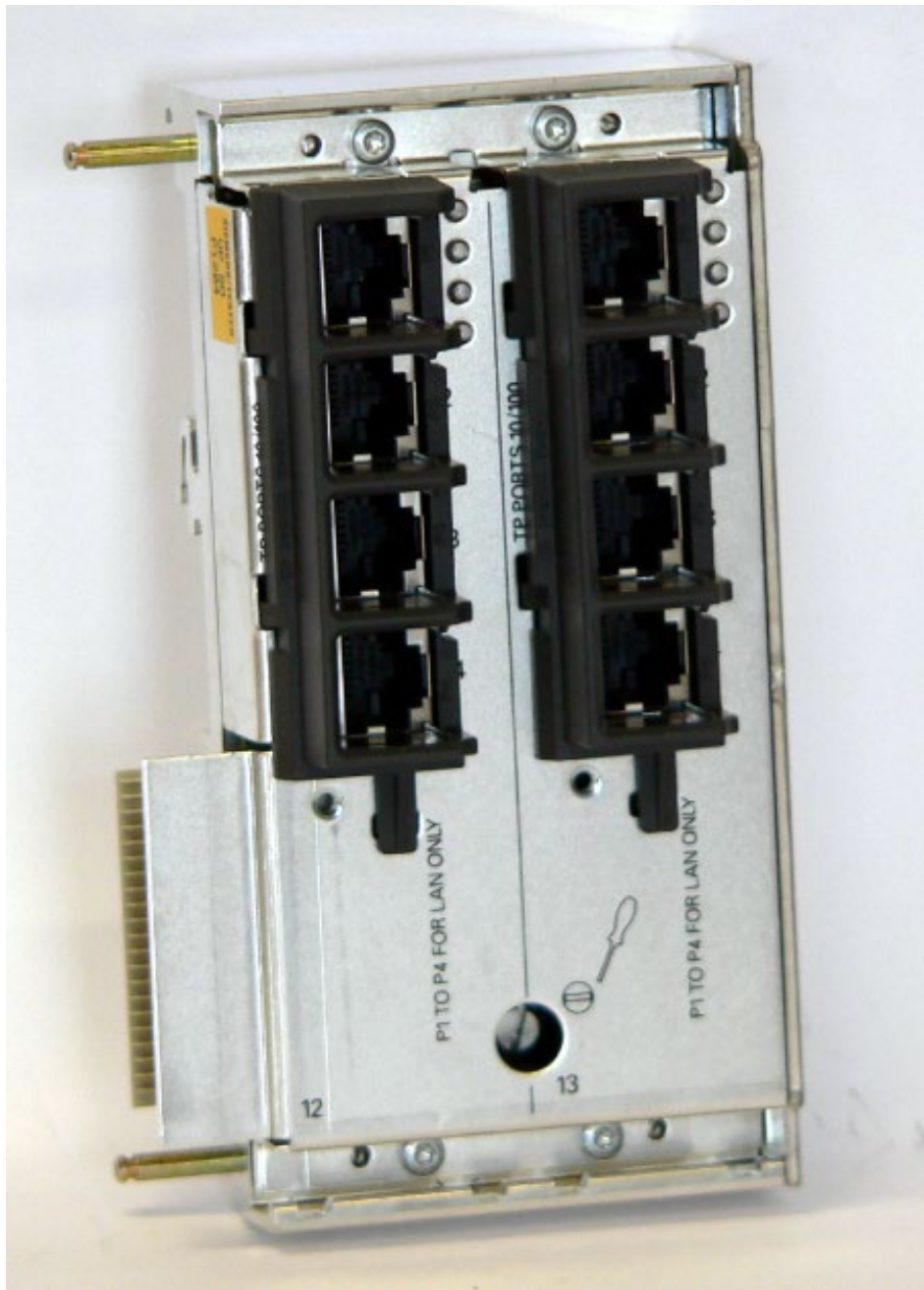

Figure 3-28 Twisted pair extender EM495-8

Covers

For slots 12 and 13 of the twisted pair extender EM495-8, you can use the cover that can be used on slots 9 through 11 on the basic device. Two CV490 4x100 covers are supplied with the twisted pair extender.

3.4.5.2 EM496-4 extender for media modules

Four additional slots for media modules

Note

The EM496-4 extender module can be used only in conjunction with the SCALANCE X414-3E.

The SCALANCE X408-2 has no port for an extender module.

By adding the media module extender, the basic device is extended by four slots that you can equip with the following modules as required:

- MM491-2
- MM491-2LD
- MM491-2LH+

If you use all slots, you have an additional eight optical Fast Ethernet ports available (100 Mbps).

Note

Installation of the media module extender and removal or insertion of the media modules is NOT possible during operation.

You require at least one media module for data transfer over this extender module.

Mixed operation in slots 12 through 15 with MM491-2, MM491-2 LD and MM491-2LH+ modules is possible. The media module plug connectors are protected by protective caps.

Connector

Depending on the media module, the connectors used are 2x2 BFOC sockets or SC duplex sockets.

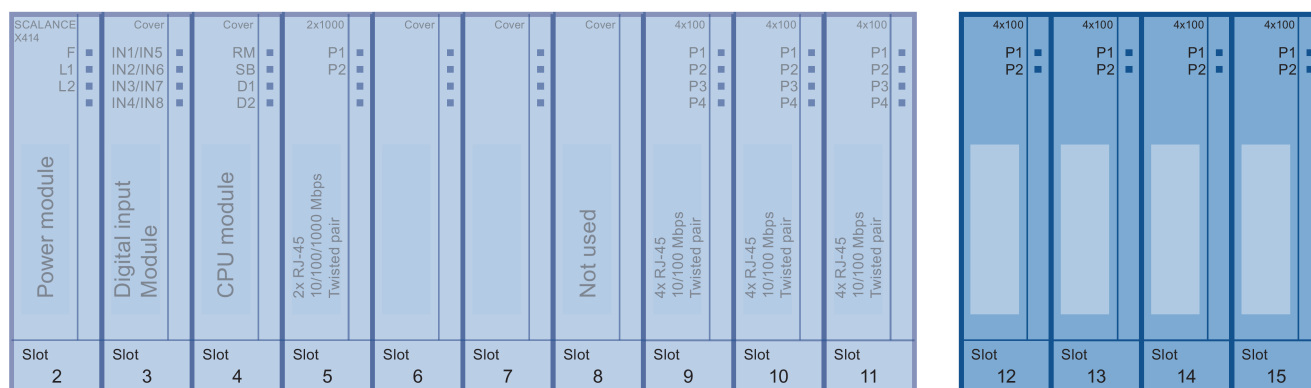

Figure 3-29 Basic device with media module extender

3.4 Description of the product



Figure 3-30 Empty media module extender EM496-4 without protective caps for the media module terminal strips and without cover

Covers

Four CV490 2x100 covers are supplied with the twisted media module extender EM496-4. The media module plug connectors are also protected from damage by protective caps.



Figure 3-31 Media module extender EM496-4 with media module MM491-2 in slot 12 and with cover

3.4.6 C-PLUG (configuration plug)

Application

The C-PLUG is an exchangeable medium for storage of the configuration data of the modular switch and ships with the product. This means that the configuration data remains available if the basic device is replaced.

Note

The C-PLUG must only be removed or inserted when the power supply to the device is turned off.

How it works

Power is supplied by the end device. The C-PLUG retains all data permanently when the power is turned off.

If an empty C-PLUG (factory settings or deleted with the Clean function) is inserted, all the configuration data of the IE Switch X-400 is saved to it automatically when the device starts up. Changes to the configuration during operation without operator intervention are saved on the C-PLUG if this is in the "ACCEPTED" status.

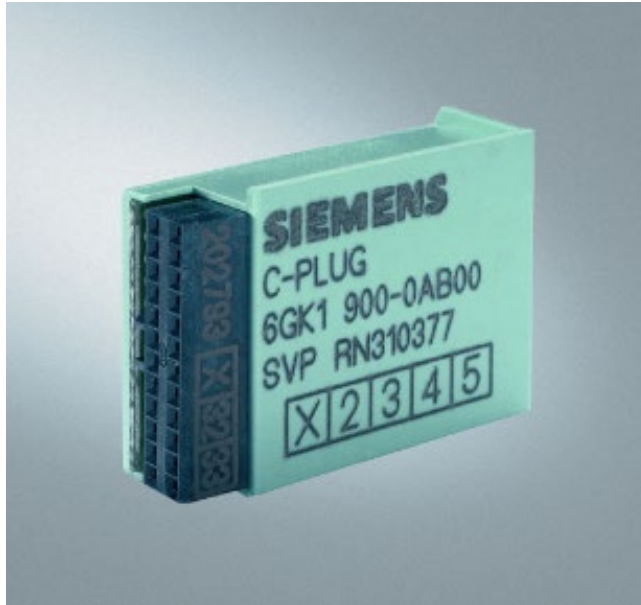

Figure 3-32 C-PLUG

A device with an "ACCEPTED" C-PLUG inserted uses the configuration data of the C-PLUG automatically when it starts up. Acceptance is possible only when the data was written by a compatible device type.

This allows a basic device to be replaced quickly and simply. The C-PLUG is taken from the failed component and inserted in the replacement. The first time it is started up, the replacement device has the same configuration as the failed device except for the MAC address set by the vendor.

Note

If an IE Switch X-400 is replaced, the configuration with media modules and when using a SCALANCE X414-3E also the settings of the DIL switches on the CPU module and the optional configuration of extender modules must be adopted.

Diagnostics

Inserting a C-PLUG that does not contain the configuration of a compatible device type, accidentally removing the C-PLUG or general malfunctions of the C-PLUG are signaled by the diagnostics mechanisms of the device (LEDs, WEB-based management, SNMP, and CLI).

Startup behavior

	C-PLUG	IE Switch X-400 startup
1	not found	with internal configuration (if it exists) or with factory defaults.
2	empty	with internal configuration, immediately copies this automatically to the C-PLUG
3	written with own configuration data	with C-PLUG configuration
4	written with other configuration data	with third-party C-PLUG configuration
5	written with configuration data of a different device type	with internal configuration, red LED on power module and log entry
6	defective	with internal configuration, red LED on power module and log entry

In cases 1 and 2, the configuration data on the CPU module and the C-PLUG is identical. In cases 3 and 5 the configuration data is different and can be synchronized manually. In case 6, you can attempt to reformat the C-PLUG with the clean function. If problems persist, replace the C-PLUG.

Note

When using a SCALANCE X414-3E, in case 4 (replacing the switch), the DIL switch settings of the C-PLUG and not the physical switch settings are adopted. A deviation is signaled by the diagnostic options.

For more detailed information, refer to the configuration manual "SCALANCE X-300 SCALANCE X-400 Industrial Ethernet Switches".

3.4 Description of the product

3.4.7 SCALANCE X-400 covers and dummy covers

3.4.7.1 SCALANCE X414-3E covers/dummy covers

Slots of the covers

Note

The protective caps for the media module terminal strips and the covers must be fitted in all slots that do not contain media modules.

For slots for twisted pair (9 through 11), the covers are recommended to protect the RJ-45 jacks.

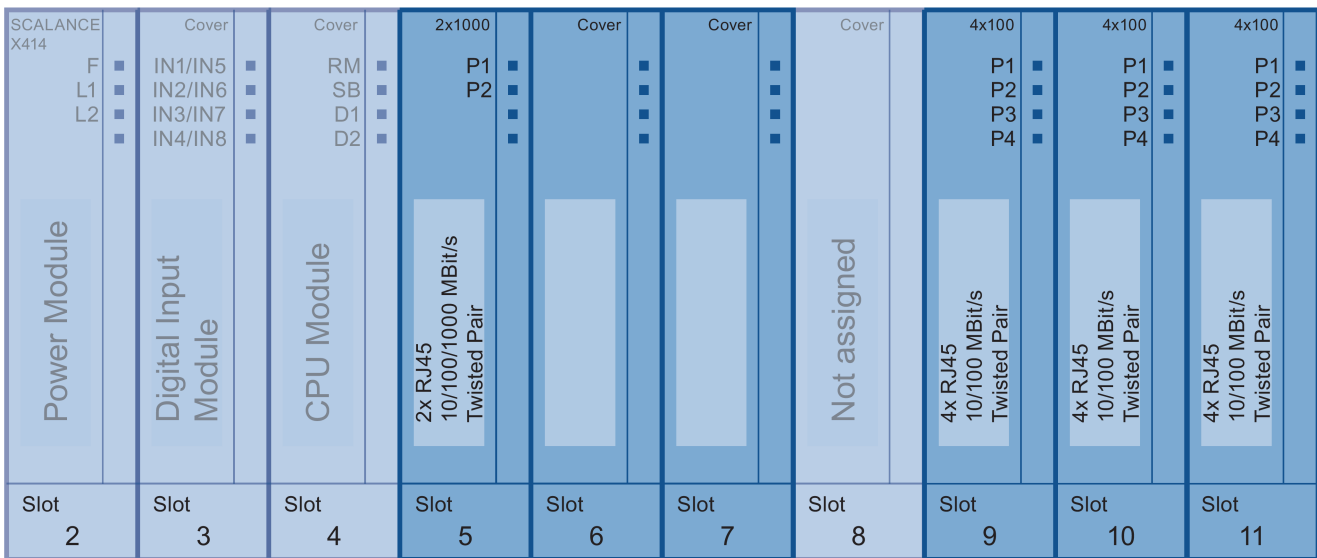

Figure 3-33 Possible slots of the covers

Available cover types

To cover slots not used for media modules or slots for twisted pair, the following types of cover are available:

- CV490 2x1000
- CV490 2x100
- CV490 4x100
- CV490 COVER

CV490 2x1000

When using the gigabit ports for electrical cables (twisted pair), use cover type CV490 2x1000 on slot 5.

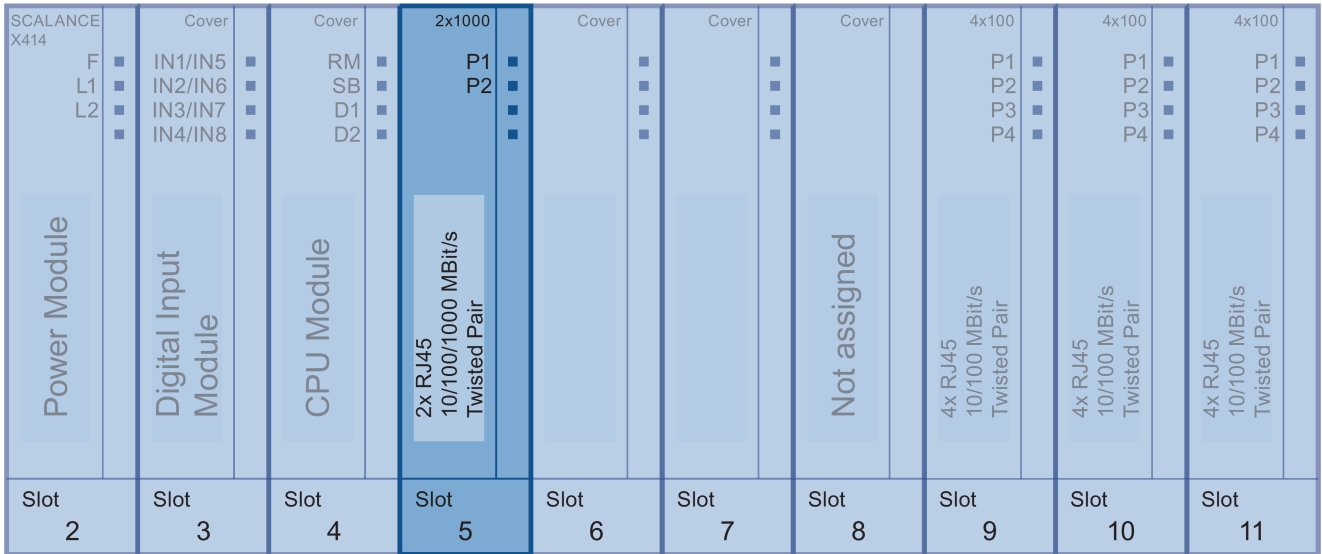

Figure 3-34 Slot 5 for the CV490 2x1000 cover

Displays of the cover

The port status of the two electrical gigabit ports 1 and 2 are displayed on the front panel of the cover by two LEDs.

3.4 Description of the product

CV490 2x100

Slots 6 and 7 are solely for the Fast Ethernet media modules MM491-2, MM491-2LH+ and MM491-2LD. The basic device does not provide any ports on these slots.

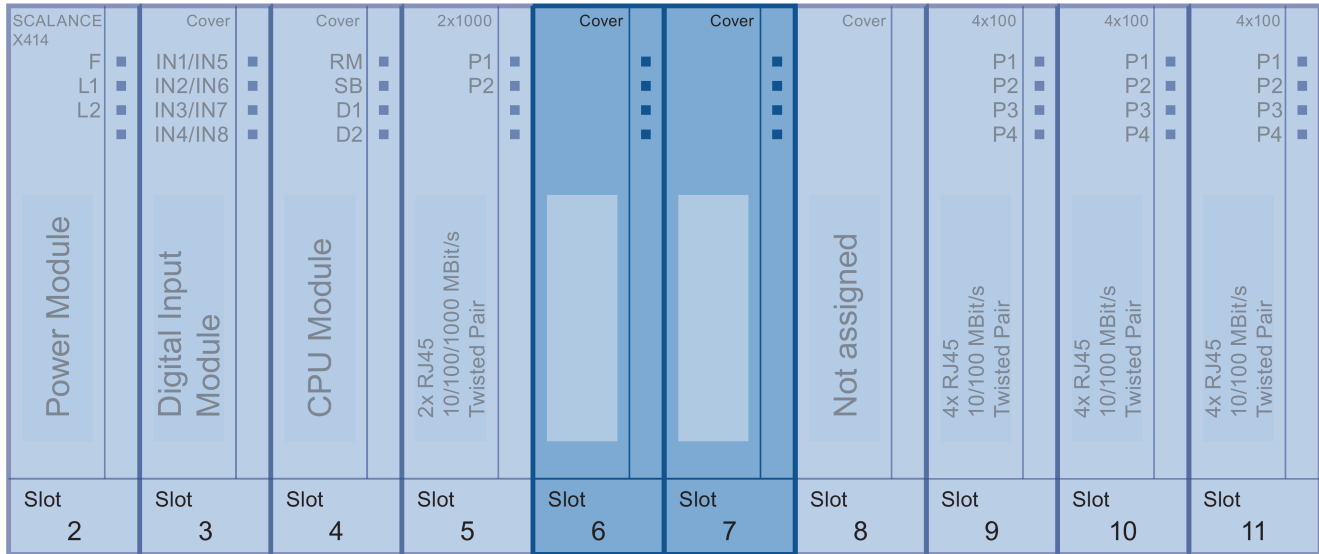

Figure 3-35 Slots 6 and 7 for the CV490 2x100 cover

Displays of the cover

The LEDs of the CV490 2x100 cover have no function.

Further slots for the CV490 2x100 cover

Use the CV490 2x100 cover not only for the SCALANCE X414-3E but also for slots 12 through 15 of the media module extender EM496-4 if no media modules are inserted.

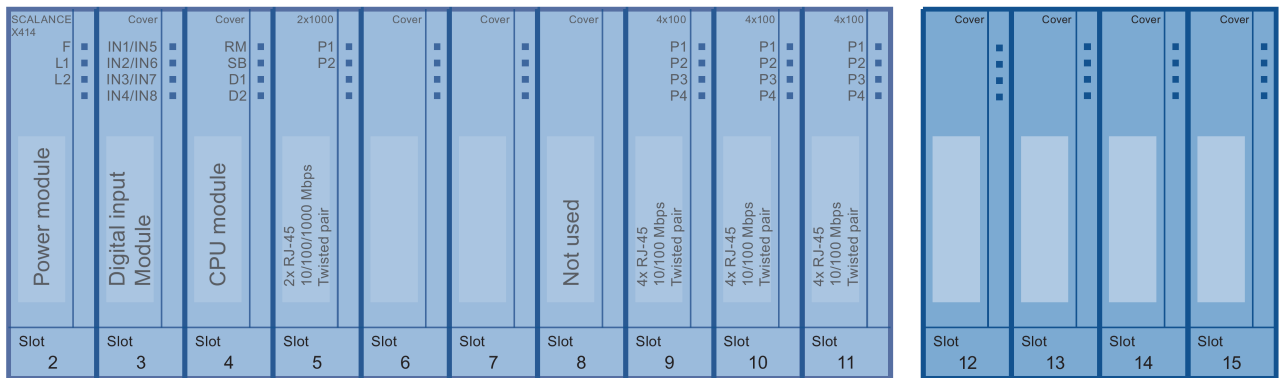

Figure 3-36 Slots 12 through 15 for CV490 2x100 cover on media module extender EM496-4

CV490 4x100

The SCALANCE X414-3E provides you with four electrical Fast Ethernet ports on slots 9 through 11.

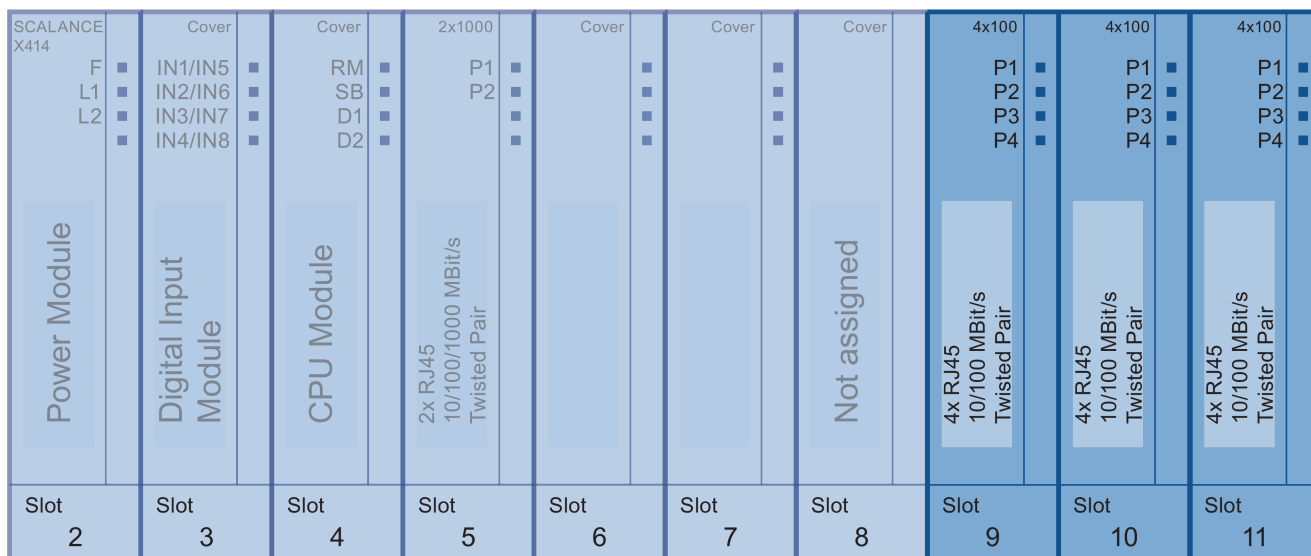

Figure 3-37 Slots 9 to 11 for CV490 4x100 cover

Displays of the cover

The status of each of the four Fast Ethernet ports 1 through 4 is displayed on the front panel of the CV490 4x100 cover by four LEDs.

Further slots for the CV490 4x100 cover

The CV490 4x100 cover can not only be used with the SCALANCE X414-3E but also for slots 12 and 13 of the twisted pair extender EM495-8.

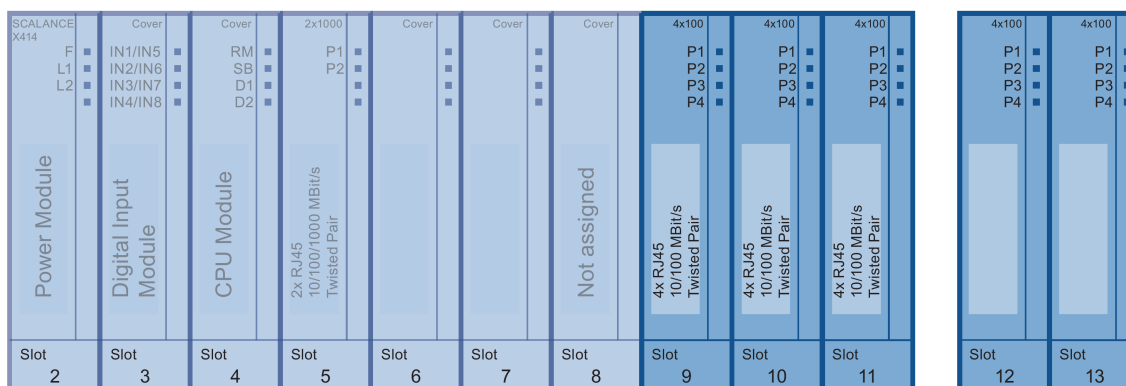

Figure 3-38 Slots 12 and 13 for the CV490 4x100 cover on the twisted pair extender module EM495-8

3.4 Description of the product

CV490 COVER

The dummy cover with the name CV490 COVER is located in slot 8.
 Due to system requirements, this slot has no function.

SCALANCE X414	Cover	Cover	2x1000	Cover	Cover	Cover	4x100	4x100	4x100
F ■	IN1/IN5 ■	RM ■	P1 ■	■	■	■	P1 ■	P1 ■	P1 ■
L1 ■	IN2/IN6 ■	SB ■	P2 ■	■	■	■	P2 ■	P2 ■	P2 ■
L2 ■	IN3/IN7 ■	D1 ■	■	■	■	■	P3 ■	P3 ■	P3 ■
■	IN4/IN8 ■	D2 ■	■	■	■	■	P4 ■	P4 ■	P4 ■
Power Module	Digital Input Module	CPU Module	2x RJ45 10/100/1000 MBit/s Twisted Pair			Not assigned	4x RJ45 10/100 MBit/s Twisted Pair	4x RJ45 10/100 MBit/s Twisted Pair	4x RJ45 10/100 MBit/s Twisted Pair
Slot 2	Slot 3	Slot 4	Slot 5	Slot 6	Slot 7	Slot 8	Slot 9	Slot 10	Slot 11

Figure 3-39 Slot 8 of the dummy cover SCALANCE X414-3E

Displays of the dummy cover

The LEDs of the dummy cover have no function and there is therefore no port information on the front panel of the dummy cover.

3.4.7.2 SCALANCE X408-2 covers/dummy covers

Slots of the covers

Note

The protective caps for the media module terminal strips and the covers must be fitted in all slots that do not contain media modules.

For slots for twisted pair (8), the covers are recommended to protect the RJ-45 jacks.

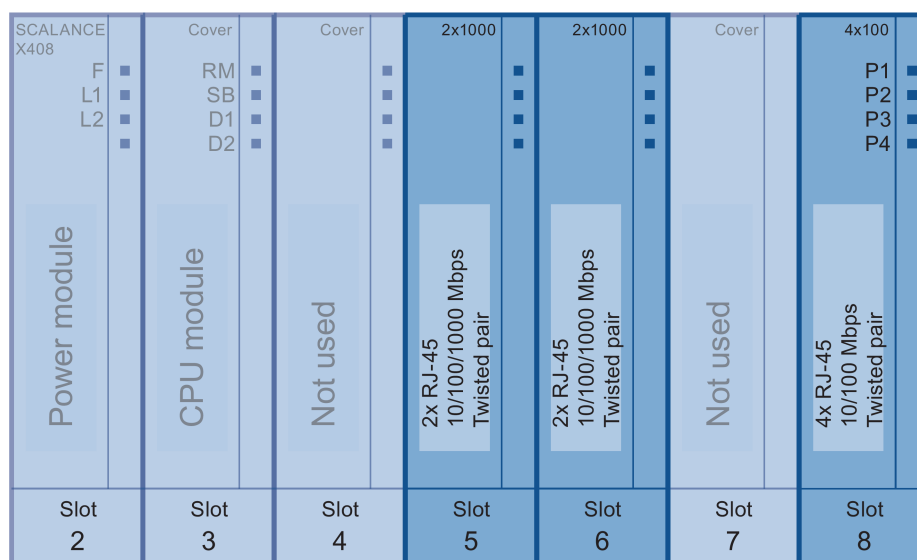

Figure 3-40 Possible slots of the covers

Available cover types

To cover slots not used for media modules or slots for twisted pair, the following types of cover are available:

- CV490 2x1000
- CV490 4x100
- CV490 COVER

CV490 2x1000

When using the gigabit ports for electrical cables (twisted pair), use cover type CV490 2x1000 on slot 5 and 6.

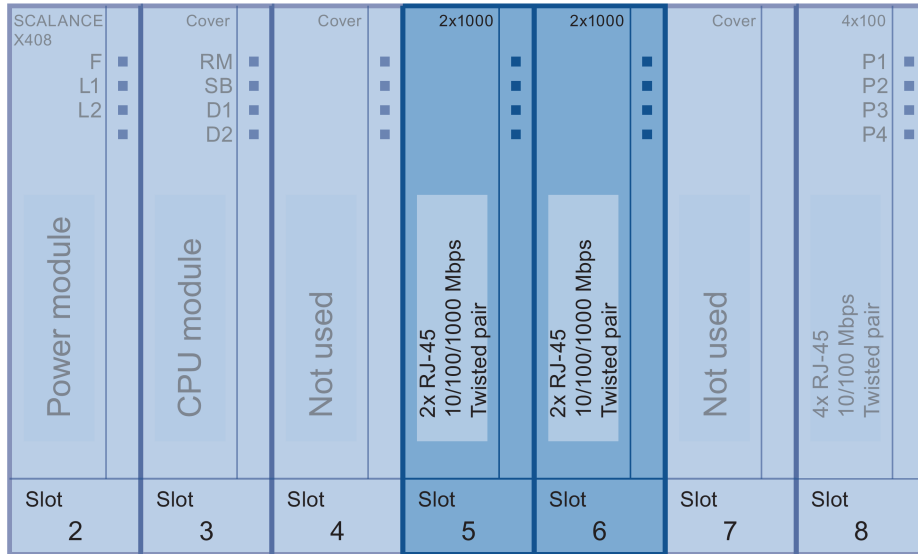

Figure 3-41 Slots 5 and 6 for cover CV490 2x1000

Displays of the cover

The port status of the two electrical gigabit ports 1 and 2 are displayed on the front panel of the cover by two LEDs.

Displays of the cover

The status of each of the two Fast Ethernet ports 1 and 2 is displayed on the front panel of the CV490 4x100 cover by two LEDs.

CV490 4x100

The SCALANCE X408-2 provides you with four electrical Fast Ethernet ports on slot 8

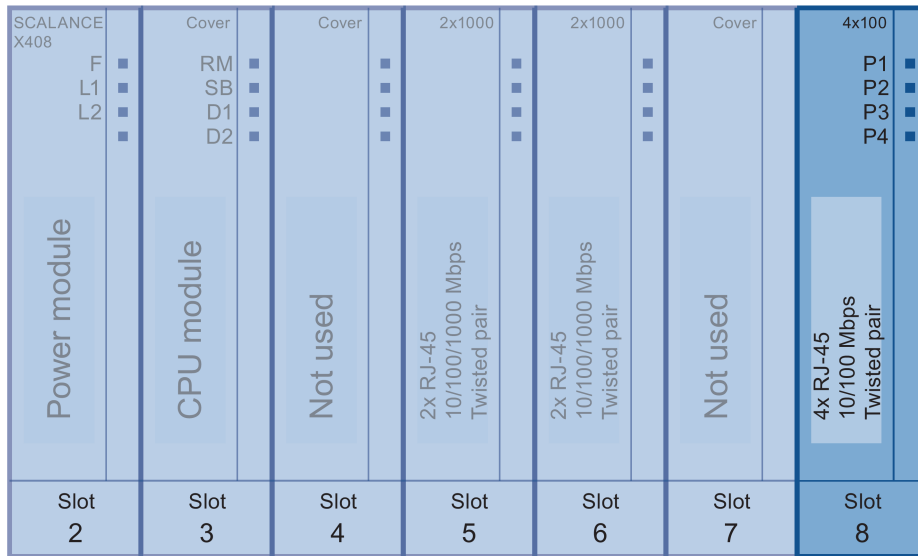

Figure 3-42 Slot 8 for the CV 490 4x100 cover

Displays of the cover

The status of each of the four Fast Ethernet ports 1 through 4 is displayed on the front panel of the CV490 4x100 cover by four LEDs.

CV490 COVER

The dummy cover with the name CV490 COVER is located on slot 4 and 7. Due to system requirements, these slots have no function.

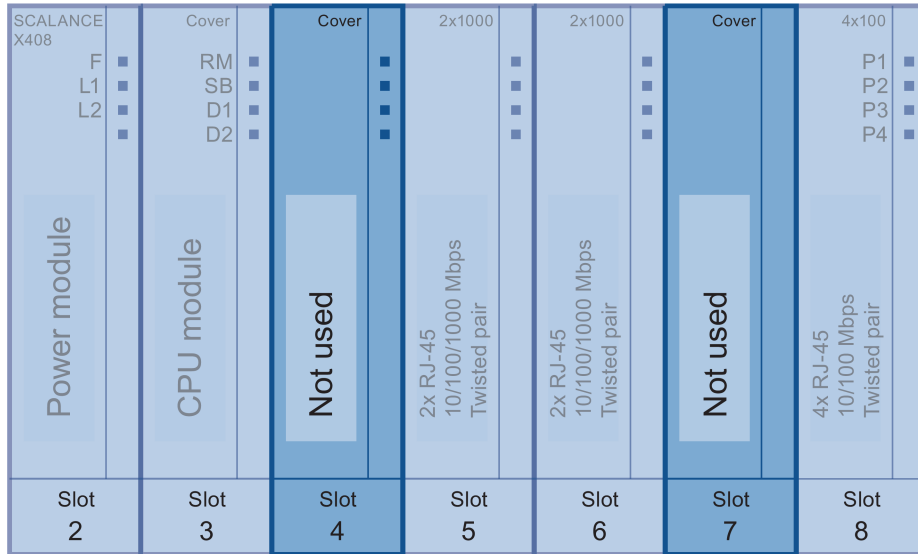

Figure 3-43 Slot 4 and 7 of the dummy cover SCALANCE X408-2

Displays of the dummy cover

The LEDs of the dummy cover have no function and there is therefore no port information on the front panel of the dummy cover.

Installation

4.1 Safety notices for installation

Safety notices

When installing the device, keep to the safety notices listed below.

 WARNING
If a device is operated in an ambient temperature of more than 50 °C, the temperature of the device housing may be higher than 70 °C. The device must therefore be installed so that it is only accessible to service personnel or users that are aware of the reason for restricted access and the required safety measures at an ambient temperature higher than 50 °C.

Safety notices on use in hazardous areas

General safety notices relating to protection against explosion

 WARNING
EXPLOSION HAZARD
SUBSTITUTION OF COMPONENTS MAY IMPAIR SUITABILITY FOR CLASS I, DIVISION 2 OR ZONE 2.

 WARNING
The device may only be operated in an environment with pollution degree 1 or 2 (see IEC 60664-1).

 WARNING
When used in hazardous environments corresponding to Class I, Division 2 or Class I, Zone 2, the device must be installed in a cabinet or a suitable enclosure.

Safety notices for use according to ATEX and IECEx

If you use the device under ATEX or IECEx conditions you must also keep to the following safety notices in addition to the general safety notices for protection against explosion:

 **WARNING**

To comply with EC Directive 94/9 (ATEX95) or the conditions of IECEx, this enclosure or cabinet must meet the requirements of at least IP54 in compliance with EN 60529.

 **WARNING**

Requirements for the cabinet/enclosure

The fiber-optic bus connections labeled SCALANCE MM400 (see type plate) may also be led through a hazardous area zone1 (see chapter Approvals (Page 133), section "ATEX").

 **WARNING**

If the temperature of the cable or housing socket exceeds 70 °C or the branching point of conductors exceeds 80 °C, special precautions must be taken. If the equipment is operated in an air ambient in excess of 50 °C to 70 °C, only use cables with a permitted operating temperature of at least 80 °C.

4.2 Installing / uninstalling the SCALANCE X-400

Notes on installation

IE Switches X-400 are designed for installation on an S7-300 standard rail and installation on a 35 mm DIN rail.

Clearances

Certain minimum clearances between an IE Switch X-400 and neighboring equipment must be taken into account. These minimum clearances are necessary during installation and operation to allow the following:

- Install and remove modules,
- to allow the flow of air required for heat dissipation during operation of the IE Switches X-400.

The following figure shows the space you need to allow for an IE Switch X-400.

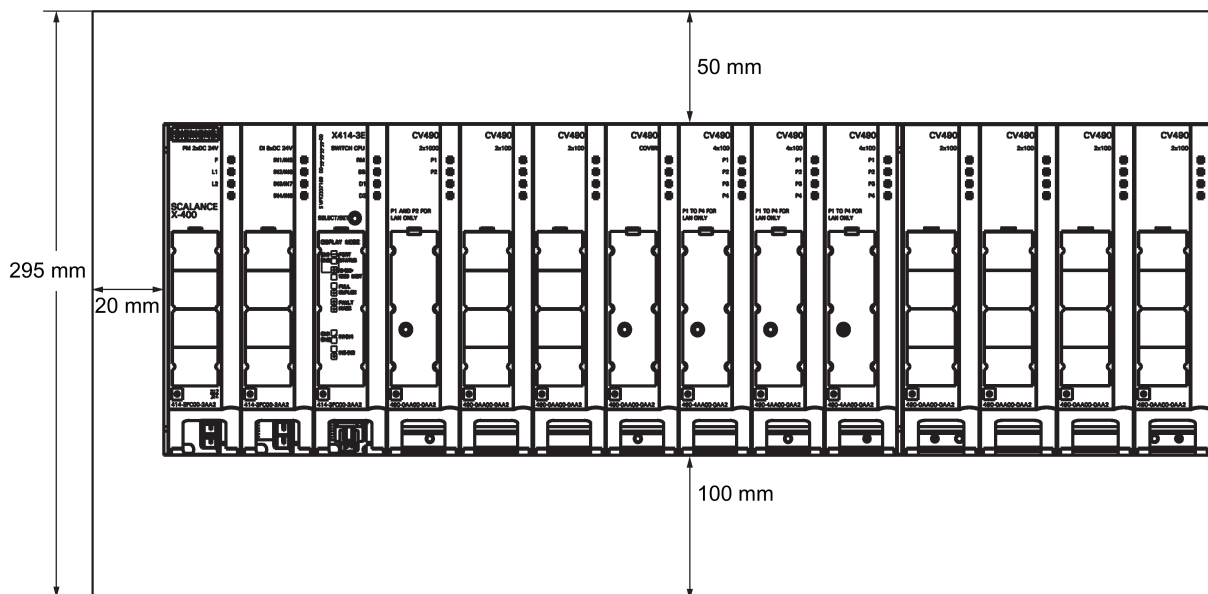

Figure 4-1 Installation clearances for the IE Switches X-400 based on the example of a SCALANCE X414-3E with extender module

4.2.1 Installing / uninstalling with an S7-300 standard rail

Installing on an S7-300 standard rail

For installation, you require a slotted screwdriver with a 5.5 mm wide blade.

Note

When installing the IE Switch X-400, hold it by the backplane and not by the modules, otherwise the device may be damaged.

To install the device, follow the steps below:

1. Tilt the basic device slightly towards the back with the upper groove on the edge of the S7-300 standard rail and push in towards the bottom. In this position, the basic device should not slip off but it can be adjusted horizontally to the left or right until the required position is achieved.
2. Remove the covers and the dummy cover.
3. If media modules are inserted, remove them as well.
First loosen the screw below the labeling strip of the module.
4. Using a screwdriver with a 5.5 mm wide blade, tighten the two captive screws in the backplane until the basic device can no longer be moved to the side.

Note

Only horizontal installation permitted (ventilation slit top/bottom).

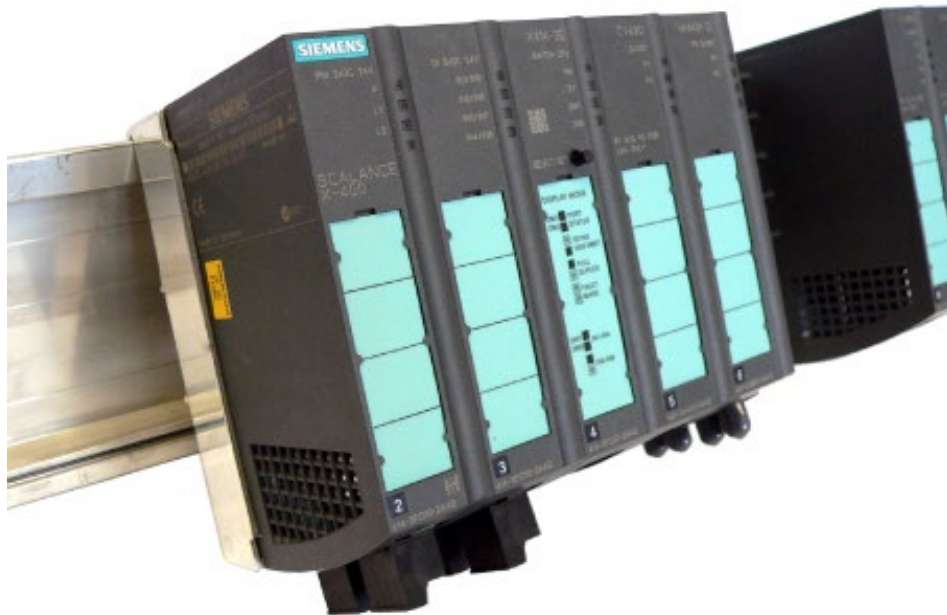

Figure 4-2 Installing on an S7-300 standard rail

Removing from the S7-300 standard rail

To remove the device, you require a slotted screwdriver with a 5.5 mm wide blade.

Note

When uninstalling the IE Switch X-400, hold it by the backplane and not by the modules, otherwise the device may be damaged.

To remove the device, follow the steps below:

1. Remove the covers and the dummy cover.
2. If media modules are inserted, remove them as well.
First loosen the screw below the labeling strip of the module.
3. Using a slotted screwdriver with a 5.5 mm wide blade, loosen the two captive screws in the backplane.
4. Pull out the lower part of the basic device slightly towards the front and lift it from the S7-300 standard rail.

4.2.2 Installing / uninstalling with a 35 mm DIN rail

Installation on a 35 mm DIN rail

 CAUTION
--

If the IE Switch X-400 is liable to be subjected to severe vibration (> 10 g), use the S7-300 standard rail for installation. The DIN rail does not provide adequate support for the IE Switch X-400 with vibration greater than 10 g.
--

Since the two captive screws are not used to secure the device when installing on a 35 mm DIN rail, it is not absolutely necessary to remove the covers and the blind cover, although this does make it easier to handle the basic device.

Note

When installing the IE Switch X-400, hold it by the backplane and not by the modules, otherwise the device may be damaged.

To install the device, follow the steps below:

1. Place the central groove containing two spring clips on the back of the basic device on the upper edge of the DIN rail with the device tilted slightly towards the back. Note that both spring clips must be located behind the edge of the DIN rail.
2. Press the basic device down and push in the lower part until you hear it click into place in the DIN rail.
3. Adjust the basic device to the right or left until it is in the required position.

Note

Only horizontal installation permitted (ventilation slit top/bottom).



Figure 4-3 Installing the SCALANCE X414-3E on a 35 mm DIN rail

Removing the SCALANCE X414-3E from a 35 mm DIN rail

Since the two captive screws are not used to secure the device when removing from a 35 mm DIN rail, it is not absolutely necessary to remove the covers and the blind cover, although this does make it easier to handle the basic device.

Note

When uninstalling the SCALANCE X414-3E, hold it by the backplane and not by the modules, otherwise the device may be damaged.

To remove the device, follow the steps below:

1. Push the basic device down until the lower part can be pulled away from the rail to the front.
2. Lift the IE Switch X-400 up and off the DIN rail.

Removing the SCALANCE X408-2 from a 35 mm DIN rail

Since the two captive screws are not used to secure the device when removing from a 35 mm DIN rail, it is not absolutely necessary to remove the covers and the blind cover, although this does make it easier to handle the basic device.

Note

When uninstalling the SCALANCE X408-2, hold it by the backplane and not by the modules, otherwise the device may be damaged.

To remove the device, follow the steps below:

1. Using a slotted screwdriver with a 5.5 mm wide blade, pull down the clip on the basic device slightly and pull out the lower part of the basic device to the front so that the spring clips can no longer engage.
2. Lift the IE Switch X-400 up and off the DIN rail.



Figure 4-4 Removing the SCALANCE X408-2 from a 35 mm DIN rail

4.3 Installing / removing the media modules, covers, and dummy cover

4.3.1 Installing / removing a media module

Installing a media module

For installation, you require a slotted screwdriver with a 2.8 mm wide blade.

Note

Installing a Fast Ethernet media module is the same in the IE Switch X-400 and in the media module extender.

1. Remove the cover from the slot of the media module and remove the protective cap of the module terminal strip underneath from the backplane of the basic device.

Note

Keep these parts in a safe place in case you want to remove the media module later.

2. Remove the inserted labeling strip from the front of the media module.
3. Place the two lower guides of the media module into the recesses at the lower edge of the basic device. It should no longer be possible to move the media module to the side.
4. Tilt the media module at an angle towards the back until the two plastic pins at the back top edge of the media module jut into the recesses in the basic device. The terminal strip of the media module must fit into the guide in the backplane.
5. Press the upper part of the media module onto the basic device until the fluted middle section of the media module is heard to click into place.
6. Tighten the captive screw on the front of the media module with a slotted screwdriver with a 2.8 mm wide blade.
7. Secure the labeling strip on the front of the media module.



Figure 4-5 Inserting a media module

Removing a media module

To remove the device, you require a slotted screwdriver with a 2.8 mm wide blade.

Note

Removing a Fast Ethernet media module is the same in the IE Switch X-400 and in the media module extender.

1. Remove the inserted labeling strip from the front of the media module.
2. Release the captive screw on the front of the media module as far as it will go with a slotted screwdriver with a 2.8 mm wide blade.
3. Press on the fluted middle section of the top of the media module next to the backplane.
4. At the same time, tilt the media module down at an angle, the two guides initially remain in the recesses at the lower edge of the basic device.
5. Remove the media module by pulling it upwards.
6. Fit the protective cap on the module terminal strip on the backplane of the basic device. Fit a suitable cover on the slot of the media module.

4.3.2 Fitting / removing a cover/dummy cover

Variants of the covers/dummy cover

There are three variants of the covers

- CV490 2x1000
1 Gbps, electrical transmission, 2 port displays
possible slots:
SCALANCE X414-3E: 5
SCALANCE X408-2: 5 and 6
- CV490 2x100
possible slots
SCALANCE X414-3E: 6, 7 and extender module EM496-4 slots 12 through 15
- CV490 4x100
10/100 Mbps, electrical transmission, 4 port displays
possible slots
SCALANCE X414-3E: 9 through 11 and extender module EM495-8 slots 12, 13
SCALANCE X408-2: 8

There is a dummy cover

- CV490 COVER
(no displays connected to front)
possible slots
SCALANCE X414-3E: 8
SCALANCE X408-2: 4 and 7

Fitting a cover/dummy cover

There is only a dummy cover (no port displays to the front) on slot 8 (SCALANCE X414-3E) or slot 7 (SCALANCE X408-2).

To fit a cover, you do not require any tools.

1. Place the two lower guides of the cover/dummy cover into the recesses at the lower edge of the basic device. It should no longer be possible to move the cover/dummy cover to the side.
2. Tilt the cover/dummy cover at an angle towards the back until the two plastic pins at the back top edge of the cover/dummy cover jut into the recesses in the basic device.
3. Press the upper part of the cover/dummy cover onto the basic device until the fluted middle section of the cover/dummy cover is heard to click into place.
4. Secure the labeling strip on the front of the cover/dummy cover.

Removing a cover/dummy cover

To remove a cover, you do not require any tools.

1. Press on the fluted middle section of the top of the cover/dummy cover next to the backplane.
2. At the same time, tilt the cover/dummy cover down at an angle, the two guides initially remain in the recesses at the lower edge of the basic device.
3. Remove the cover/dummy cover by pulling it upwards.

4.4 Installing / uninstalling the extender modules for SCALANCE X414-3E

4.4.1 Installing/uninstalling the EM495-8 twisted pair extender for SCALANCE X414-3E

Installing the twisted pair extender on the S7-300 standard rail

You require the following tools:

- slotted screwdriver with a 2.8 mm wide blade
- slotted screwdriver with a 5.5 mm wide blade

Note

Make sure that in addition to the extender width of 87 mm, there is a clearance of 20 mm to the right of the basic device on the standard rail to be able to align the guide bolts of the extender with the holes in the basic device during installation.

When installing a twisted pair extender on an S7-300 standard rail, the basic device remains in position. Follow the steps below:

1. Remove the cover from slot 11 of the basic device.
2. Remove the right-hand side panel of the basic device. To do this, use a slotted screwdriver with a 2.8 mm wide blade to loosen the two captive slug screws on slot 11 in the upper and lower recesses as far as they will go.
3. Remove the side panel of the basic device from the basic device to the right.

Note

Keep the panel in a safe place in case the extender needs to be removed again later.

4. Remove the two covers from the extender.
5. Place the extender module on the edge of the S7-300 standard rail with the upper groove angled slightly towards the back and tilt the extender towards the back. Make sure that there is adequate clearance between the guide bolts of the extender module and the basic device. In this position, the extender module should not be able to slip off, however it can be moved horizontally in both directions.
6. Push the extender module slowly to the left while keeping it straight and without skewing and check that the two guide bolts on the extender fit into the holes in the basic device. Then push the extender module to the left as far as it will go so that it is flush with the right side of the basic device.
7. Using a slotted screwdriver with a 5.5 mm wide blade, tighten the captive screw between slots 12 and 13 in the lower part of the extender module.

4.4 Installing / uninstalling the extender modules for SCALANCE X414-3E

8. Using a slotted screwdriver with a 2.8 mm wide blade, tighten the two captive slug screws on slot 11. The screws lock the two guide bolts, so do not use excessive force when tightening them.
9. Fit the CV490 4x100 cover to slot 11 of the basic device and slots 12 and 13 of the twisted pair extender.



Figure 4-6 Installing the twisted pair extender on the S7-300 standard rail

Removing the twisted pair extender from the S7-300 standard rail

You require the following tools:

- slotted screwdriver with a 2.8 mm wide blade
- slotted screwdriver with a 5.5 mm wide blade

When removing a twisted pair extender from an S7-300 standard rail, the basic device remains in position. Follow the steps below:

1. To remove an extender module, remove the two covers on the extender.
2. Using a slotted screwdriver with a 5.5 mm wide blade, open the captive screw between slots 12 and 13 in the lower part of the extender module.
3. Remove the cover from slot 11 of the basic device.
4. Use a slotted screwdriver with a 2.8 mm wide blade to loosen the two captive slug screws on slot 11 of the basic device in the upper and lower recesses as far as they will go.
5. Push the extender module slowly to the right while keeping it straight until the two guide bolts of the extender module are completely outside the holes in the basic device.
6. Pull out the lower part of the extender module slightly towards the front and lift it from the S7-300 standard rail.

7. Replace the right side panel of the basic device so that the guide bolts fit into the two holes in the basic device.
8. Using a slotted screwdriver with a 2.8 mm wide blade, tighten the two captive slug screws on slot 11. The screws lock the two guide bolts, so do not use excessive force when tightening them.
9. Fit a suitable cover on slot 11 of the basic device.

Note

The basic device must not be used permanently without the right side panel.

Installing the twisted pair extender on the 35 mm DIN rail

CAUTION

If the IE Switch X-400 with extender is liable to severe vibration (> 10 g), use the S7-300 standard rail for installation. The DIN rail does not provide adequate support for the twisted pair extender with vibration greater than 10 g.

For installation, you require a slotted screwdriver with a 2.8 mm wide blade.

Although the captive screw in the lower part between slots 12 and 13 of the extender module is not used when installing on a 35 mm DIN rail, it is nevertheless advisable to remove the media modules.

Note

Make sure that in addition to the extender width of 87 mm, there is a clearance of 20 mm to the right of the basic device on the DIN rail to be able to align the guide bolts of the extender with the holes in the basic device during installation.

When installing a twisted pair extender on a 35 mm DIN rail, the basic device remains in position. Follow the steps below:

1. Remove the cover from slot 11 of the basic device.
2. Remove the right-hand side panel of the basic device. To do this, use a slotted screwdriver with a 2.8 mm wide blade to loosen the two captive slug screws on slot 11 in the upper and lower recesses as far as they will go.
3. Remove the side panel of the basic device from the basic device to the right.

Note

Keep the panel in a safe place in case the extender needs to be removed again later.

4. Place the central groove containing a spring clip on the back of the extender module on the upper edge of the DIN rail with the module tilted slightly towards the back. Make sure that there is adequate clearance between the guide bolts of the extender module and the basic device.

5. The spring clip must be located behind the edge of the DIN rail so that it is visible from the rear of the frame.
6. Press the extender module down and push in the lower part until you hear it click into place in the DIN rail.
7. Push the extender module slowly to the left while keeping it straight and without skewing and check that the two guide bolts on the extender fit into the holes in the basic device. Then push the extender module to the left as far as it will go so that it is flush with the right side of the basic device.
8. Using a slotted screwdriver with a 2.8 mm wide blade, tighten the two captive slug screws on slot 11. The screws lock the two guide bolts, so do not use excessive force when tightening them.
9. Fit the CV490 4x100 cover to slot 11 of the basic device and slots 12 and 13 of the twisted pair extender.



Figure 4-7 Installing the twisted pair extender on the 35 mm DIN rail

Removing the twisted pair extender from the 35 mm DIN rail

To remove the device, you require a slotted screwdriver with a 2.8 mm wide blade. The captive screw in the lower part of the extender module between slot 12 and 13 is not used for mounting on an 35 mm DIN rail. When removing a twisted pair extender from a 35 mm DIN rail, the basic device remains in position. Follow the steps below:

1. Remove the cover from slot 11 of the basic device.
2. Use a slotted screwdriver with a 2.8 mm wide blade to loosen the two captive slug screws on slot 11 of the basic device in the upper and lower recesses as far as they will go.
3. Push the extender module slowly to the right while keeping it straight until the two guide bolts of the extender module are completely outside the holes in the basic device.

4. Push the twisted pair extender down until the lower part can be pulled away from the rail to the front.
5. Lift the extender module up and off the DIN rail.
6. Replace the right side panel of the basic device so that the guide bolts fit into the two holes in the basic device.
7. Using a slotted screwdriver with a 2.8 mm wide blade, tighten the two captive slug screws on slot 11. The screws lock the two guide bolts, so do not use excessive force when tightening them.
8. Fit a suitable cover on slot 11 of the basic device.

Note

The basic device must not be used permanently without the right side panel.

4.4.2 Installing / uninstalling the EM496-4 media module extender for SCALANCE X414-3E

Installing the media module extender on the S7-300 standard rail

You require the following tools:

- slotted screwdriver with a 2,8 mm wide blade
- slotted screwdriver with a 5.5 mm wide blade

Note

Make sure that in addition to the extender width of 155 mm, there is a clearance of 20 mm to the right of the basic device on the standard rail to be able to align the guide bolts of the extender with the holes in the basic device during installation.

Note

Protective caps and CV490 2x100 covers must be fitted to all slots without media modules.

When installing a media module extender on an S7-300 standard rail, the basic device remains in position. Follow the steps below:

1. Remove the cover from slot 11 of the basic device.
2. Remove the right-hand side panel of the basic device. To do this, use a slotted screwdriver with a 2.8 mm wide blade to loosen the two captive slug screws on slot 11 in the upper and lower recesses as far as they will go.

3. Remove the side panel of the basic device from the basic device to the right.

Note

Keep the panel in a safe place in case the extender needs to be removed again later.

4. Remove the four covers from the extender.
5. Place the extender module on the edge of the S7-300 standard rail with the upper groove angled slightly towards the back and tilt the extender towards the back. Make sure that there is adequate clearance between the guide bolts of the extender module and the basic device. In this position, the extender module should not be able to slip off, however it can be moved horizontally in both directions.
6. Push the extender module slowly to the left while keeping it straight and without skewing and check that the two guide bolts on the extender fit into the holes in the basic device. Then push the extender module to the left as far as it will go so that it is flush with the right side of the basic device.
7. Using a slotted screwdriver with a 5.5 mm wide blade, tighten the captive screw between slots 13 and 14 in the lower part of the extender module.
8. Using a slotted screwdriver with a 2.8 mm wide blade, tighten the two captive slug screws on slot 11. The screws lock the two guide bolts, so do not use excessive force when tightening them.
9. Fit the CV490 4x100 cover on slot 11 of the basic device. Make sure that the media module terminal strips of slots not occupied by media modules have protective caps fitted and that the CV490 2x100 covers are in place.

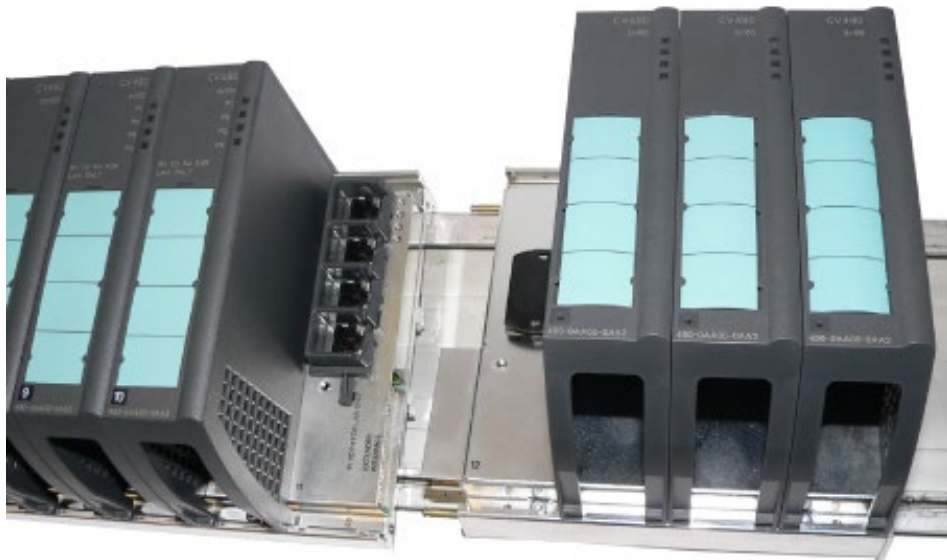

Figure 4-8 Installing the media module extender on the S7-300 standard rail

Removing the media module extender from the S7-300 standard rail

You require the following tools:

- slotted screwdriver with a 2,8 mm wide blade
- slotted screwdriver with a 5.5 mm wide blade

Note

To remove the extender, remove the media modules from slots 13 and 14.

When removing a media module extender from an S7-300 standard rail, the basic device remains in position. Follow the steps below:

1. To remove an extender module, use a slotted screwdriver with a 5.5 mm wide blade, to open the captive screw between slots 13 and 14 in the lower part of the extender module.
2. Remove the cover from slot 11 of the basic device.
3. Use a slotted screwdriver with a 2.8 mm wide blade to loosen the two captive slug screws on slot 11 of the basic device in the upper and lower recesses as far as they will go.
4. Push the extender module slowly to the right while keeping it straight until the two guide bolts of the extender module are completely outside the holes in the basic device.
5. Pull out the lower part of the extender module slightly towards the front and lift it from the S7-300 standard rail.
6. Replace the right side panel of the basic device so that the guide bolts fit into the two holes in the basic device.
7. Using a slotted screwdriver with a 2.8 mm wide blade, tighten the two captive slug screws on slot 11. The screws lock the two guide bolts, so do not use excessive force when tightening them.
8. Fit a suitable cover on slot 11 of the basic device.

Note

The basic device must not be used permanently without the right side panel.

Installing the media module extender on the 35 mm DIN rail

 CAUTION
--

If the IE Switch X-400 with extender is liable to severe vibration (> 10 g), use the S7-300 standard rail for installation. The DIN rail does not provide adequate support for the media module extender with vibration greater than 10 g.
--

For installation, you require a slotted screwdriver with a 2.8 mm wide blade.

4.4 Installing / uninstalling the extender modules for SCALANCE X414-3E

Although the captive screw in the lower part between slots 13 and 14 of the extender module is not used when installing on a 35 mm DIN rail, it is nevertheless advisable to remove the media modules.

Note

Make sure that in addition to the extender width of 155 mm, there is a clearance of 20 mm to the right of the basic device on the DIN rail to be able to align the guide bolts of the extender with the holes in the basic device during installation.

Note

Protective caps and CV490 2x100 covers must be fitted to all slots without media modules.

When installing a media module extender on a 35 mm DIN rail, the basic device remains in position. Follow the steps below:

1. Remove the cover from slot 11 of the basic device.
 2. Remove the right-hand side panel of the basic device. To do this, use a slotted screwdriver with a 2.8 mm wide blade to loosen the two captive slug screws on slot 11 in the upper and lower recesses as far as they will go.
 3. Remove the side panel of the basic device from the basic device to the right.
-

Note

Keep the panel in a safe place in case the extender needs to be removed again later.

4. Place the central groove containing a spring clip on the back of the extender module on the upper edge of the DIN rail with the module tilted slightly towards the back. Make sure that there is adequate clearance between the guide bolts of the extender module and the basic device.
5. The spring clip must be located behind the edge of the DIN rail so that it is visible from the rear of the frame.
6. Press the extender module down and push in the lower part until you hear it click into place in the DIN rail.
7. Push the extender module slowly to the left while keeping it straight and without skewing and check that the two guide bolts on the extender fit into the holes in the basic device. Then push the extender module to the left as far as it will go so that it is flush with the right side of the basic device.

8. Using a slotted screwdriver with a 2.8 mm wide blade, tighten the two captive slug screws on slot 11. The screws lock the two guide bolts, so do not use excessive force when tightening them.
9. Fit the CV490 4x100 cover on slot 11 of the basic device. Make sure that the media module terminal strips of slots not occupied by media modules have protective caps fitted and that the CV490 2x100 covers are in place.



Figure 4-9 Installing the media module extender on the 35 mm DIN rail

Removing the media module extender from the 35 mm DIN rail

To remove the device, you require a slotted screwdriver with a 2.8 mm wide blade.

Although the captive screw in the lower part between slots 13 and 14 of the extender module is not used on a 35 mm DIN rail, it is nevertheless advisable to remove the media modules. When removing a media module extender from a 35 mm DIN rail, the basic device remains in position. Follow the steps below:

1. Remove the cover from slot 11 of the basic device.
2. Use a slotted screwdriver with a 2.8 mm wide blade to loosen the two captive slug screws on slot 11 of the basic device in the upper and lower recesses as far as they will go.
3. Push the extender module slowly to the right while keeping it straight until the two guide bolts of the extender module are completely outside the holes in the basic device.
4. Push the media module extender down until the lower part can be pulled away from the rail to the front.
5. Lift the extender module up and off the DIN rail.
6. Replace the right side panel of the basic device so that the guide bolts fit into the two holes in the basic device.

4.4 Installing / uninstalling the extender modules for SCALANCE X414-3E

7. Using a slotted screwdriver with a 2.8 mm wide blade, tighten the two captive slug screws on slot 11. The screws lock the two guide bolts, so do not use excessive force when tightening them.
8. Fit a suitable cover on slot 11 of the basic device.

Note

The basic device must not be used permanently without the right side panel.

Connecting

5.1 Safety when connecting up

Safety notices

When connecting up the device, keep to the safety notices listed below.

 **WARNING**

The equipment is designed for operation with Safety Extra-Low Voltage (SELV) by a Limited Power Source (LPS).

This means that only SELV / LPS complying with IEC 60950-1 / EN 60950-1 / VDE 0805-1 must be connected to the power supply terminals. The power supply unit for the equipment power supply must comply with NEC Class 2, as described by the National Electrical Code (r) (ANSI / NFPA 70).

If the equipment is connected to a redundant power supply (two separate power supplies), both must meet these requirements.

 **WARNING**

Safety notice for connecting with a LAN ID (Local Area Network)

A LAN or LAN segment with all the interconnected devices should be contained completely in a single low voltage power distribution in a building. The LAN is designed either for "Environment A" according to IEEE802.3 or "Environment 0" according to IEC TR 62102.

Do not connect any electrical connectors directly to the telephone network (telephone network voltage) or a WAN (Wide Area Network).

Safety notices on use in hazardous areas

General safety notices relating to protection against explosion

 **WARNING**

EXPLOSION HAZARD

DO NOT CONNECT OR DISCONNECT EQUIPMENT WHEN A FLAMMABLE OR COMBUSTIBLE ATMOSPHERE IS PRESENT.

Safety notices for use according to ATEX and IECEx

If you use the device under ATEX or IECEx conditions you must also keep to the following safety notices in addition to the general safety notices for protection against explosion:

 WARNING
Take measures to prevent transient voltage surges of more than 40% of the rated voltage. This is the case if you only operate devices with SELV (safety extra-low voltage).

Safety notices when using the device according to Hazardous Locations (HazLoc)

If you use the device under HazLoc conditions you must also keep to the following safety notices in addition to the general safety notices for protection against explosion:

 WARNING
EXPLOSION HAZARD DO NOT DISCONNECT WHILE CIRCUIT IS LIVE UNLESS AREA IS KNOWN TO BE NON-HAZARDOUS.

5.2 Ports

5.2.1 Connectors of the power supply (X1) of the SCALANCE X-400

Polarity reversal protection X1, X2

The two 4-pin male connectors (X1, X2) for the power supply and the signaling contact have no polarity reversal protection. If the connectors are accidentally swapped over, this does not cause damage or destroy circuits. Normal functionality is, however, not available while the connectors are swapped over.

Connectors of the power supply (X1)

The redundant power supply is connected over a 4-pin connector at the front terminal block on the power module.

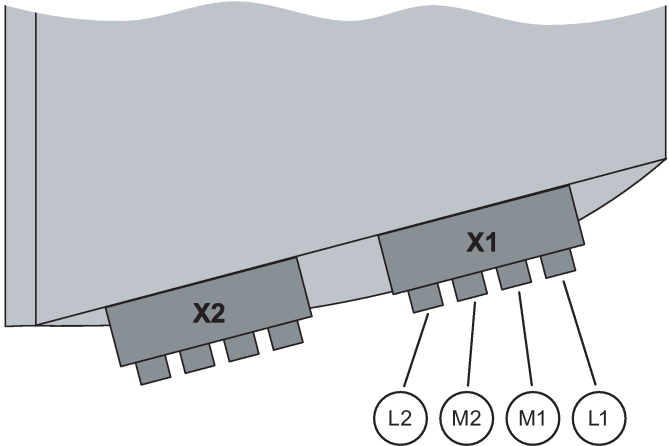

Figure 5-1 Pins of connector X1

Conn. 1	L1+	+ 24 V power supply 1
	M1	Ground
	M2	Ground
	L2+	+ 24 V power supply 2

NOTICE

If IE Switches X-400 are supplied over long 24 V power supply lines or networks, measures are necessary to prevent interference by strong electromagnetic pulses on the supply lines. These can result, for example, due to lightning or switching of large inductive loads.

One of the tests used to attest the immunity of devices of the IE Switches X-400 to electromagnetic interference is the "surge immunity test" according to EN61000-4-5. This test requires overvoltage protection for the power supply lines. A suitable device is, for example, the Dehn Blitzductor VT AD 24 V type no. 918 402 or comparable protective element.

Manufacturer: DEHN+SÖHNE GmbH+Co.KG, Hans-Dehn-Str.1, Postfach 1640, D-92306 Neumarkt, Germany.

5.2.2 Connectors of the signaling contact and grounding strap (X2) of the SCALANCE X-400

Polarity reversal protection X1, X2

The two 4-pin male connectors (X1, X2) for the power supply and the signaling contact have no polarity reversal protection. If the connectors are accidentally swapped over, this does not cause damage or destroy circuits. Normal functionality is, however, not available while the connectors are swapped over.

Connectors of the signaling contact and grounding strap (X2)

The signaling contact is connected by contacts MK1 and MK2 on the 4-pin connector to the rear terminal block on the power module.

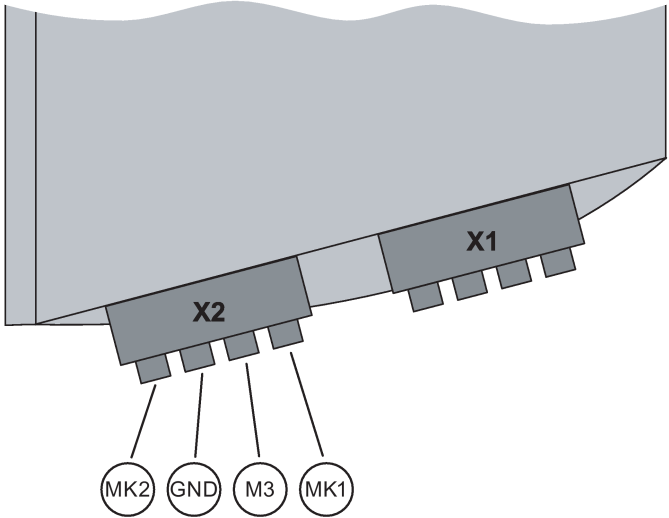

Figure 5-2 Pins of connector X2

By inserting a strap between protective earth GND and M3, IE Switches X-400 can be operated with grounded reference potential.

When the device ships, no strap is fitted (non-grounded reference potential).

Conn. 2	MK1	Floating signaling contact relay connector 1
	M3	Ground
	GND	Protective earth
	MK2	Floating signaling contact relay connector 2

5.2.3 Connectors of the digital inputs of the SCALANCE X414-3E

Polarity reversal protection X1, X2

The two 5-pin male connectors (X1, X2) of the digital inputs 1 through 8 have no polarity reversal protection. If the connectors are accidentally swapped over, this does not cause damage or destroy circuits. In display modes A and C or B and D, incorrect inputs are displayed during the time the connectors are swapped over.

 WARNING
The input voltage must not exceed + 30 V and must not fall below – 30 V, otherwise the DI module will be destroyed.

Connectors of the digital inputs 1 to 4 on male connector X1

Digital inputs 1 through 4 are connected using a 5-pin connector at the front terminal block on the DI module.

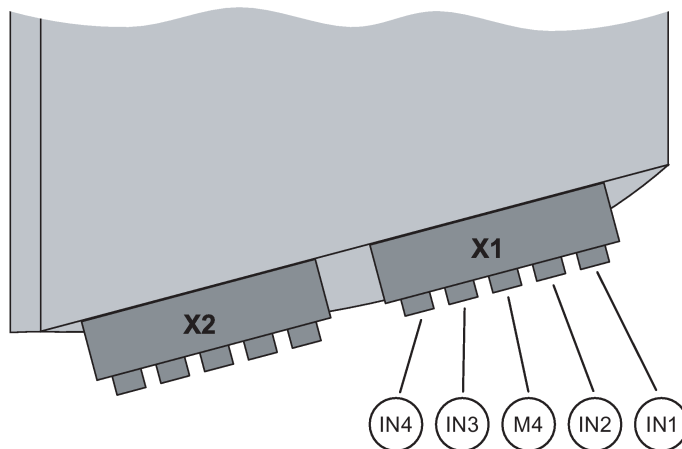

Figure 5-3 Pins of connector X1 (inputs 1-4)

Conn. 1	IN1	Digital input 1
	IN2	Digital input 2
	M4	Ground
	IN3	Digital input 3
	IN4	Digital input 4

Digital inputs 5 to 8 on male connector X2

Digital inputs 5 through 8 are connected using a 5-pin connector at the rear terminal block on the DI module.

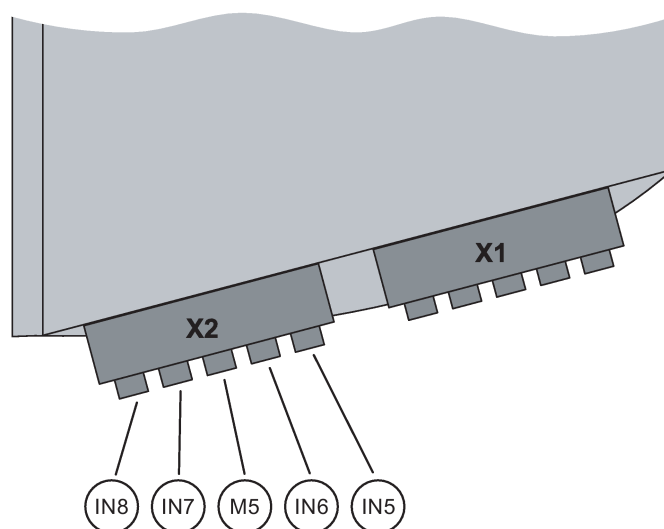

Figure 5-4 Pins of connector X2 (inputs 5-8)

Conn. 2	IN5	Digital input 5
	IN6	Digital input 6
	M5	Ground
	IN7	Digital input 7
	IN8	Digital input 8

5.2.4 Connectors for the twisted pair cables

The FastConnect cabling system

With the IE FC RJ-45 Plug and the FastConnect cables (FC), you can achieve a segment length up to 100 m without patching. In this case, the IE FC standard cable 2x2 is connected directly to the SCALANCE X414-3E and other components on the network.

Two FastConnect cable types are available, the eight-wire IE FC standard cable 4x2 and the four-wire IE FC standard cable 2x2.

The diameter of the IE FC standard cable 4x2 does not allow connection to an RJ-45 plug so that only the IE FC standard cable 2x2 as a four-wire cable is suitable for RJ-45 plugs. This means that the maximum transmission rate is 100 Mbps.

The flexible eight-wire patch cable (TP cord) for gigabit transmission allows a maximum cable length of 10 m.

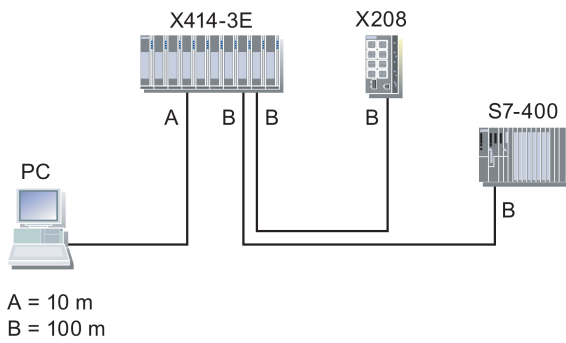

Figure 5-5 FastConnect cabling
A TP cord (1 Gbps)
B IE FC standard cable 2x2 (100 Mbps)

Connecting TP cord to FC cable

To connect TP Cord to FC cables, two IE FC RJ-45 modular outlet insert types are available:

- IE FC RJ-45 modular outlet insert 1GE
1 RJ-45 jack with 4x2 wire cable for 1 Gbps
- IE FC RJ-45 modular outlet insert 2FE
2 RJ-45 jacks each with 2x2 wire cable for 100 Mbps

With the IE FC RJ-45 modular outlet insert 1GE, the eight-wire FastConnect cable allows a transmission rate of 1 Gbps.

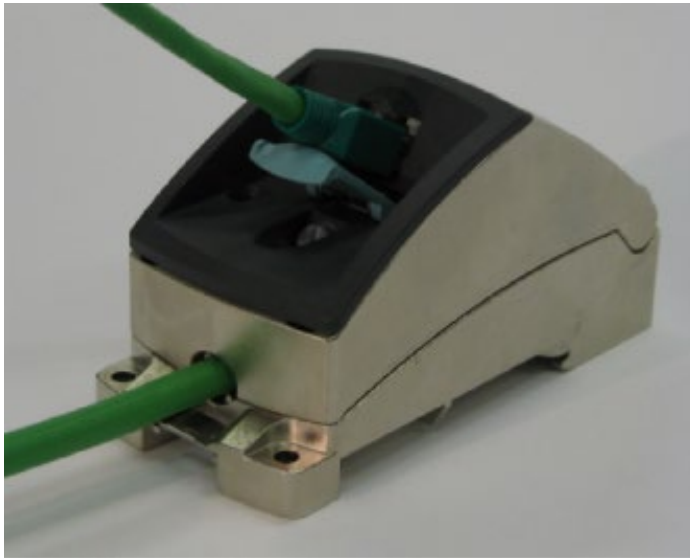

Figure 5-6 IE FC RJ-45 modular outlet insert 1GE

With the IE FC RJ-45 modular outlet insert 2FE, the eight-wire FastConnect cable is split over two RJ-45 jacks and allows a transmission rate of 2 x 100 Mbps.

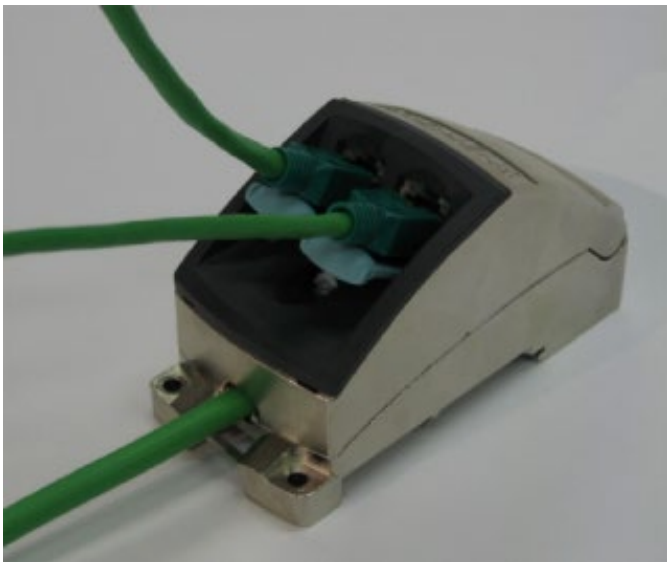

Figure 5-7 IE FC RJ-45 modular outlet insert 2FE

The maximum segment length of 100 m also applies when using the FastConnect cabling with TP cord. Normally, FastConnect cable with a length of 90 m is used. The remaining 10 m is then available for TP cord at both ends (total of 10 m).

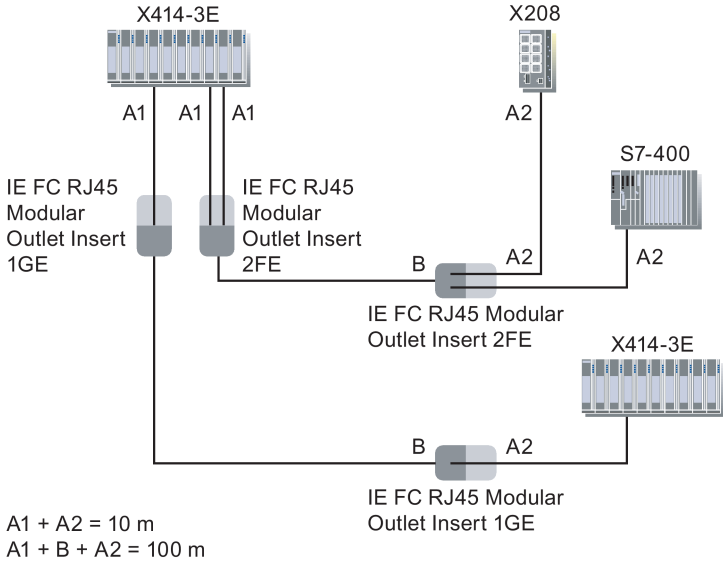

Figure 5-8 FastConnect cabling
A1 TP cord 4x2
A2 TP cord 4x2
B IE FC standard cable 4x2

Removing the FC cable from IE Switches X-400

Under some circumstances, a screwdriver is necessary to remove the twisted pair cables with RJ-45 plugs because it may not be possible to reach the connector with your hand due to neighboring media modules, covers, or the dummy cover.

If this is the situation, do the following:

1. Press the catch on the RJ-45 plug to the left with a small screwdriver.
2. Remove the cable.



Figure 5-9 Unlocking the FastConnect RJ-45 plug

5.2.5 Connectors for fiber-optic cables

Gigabit transmission with FOC

Data transmission at 1 Gbps is over multimode FOC or single mode FOC. In both cases, the fiber-optic cable is plugged into the SC duplex socket with the SC duplex plug. The connectors have polarity reversal protection mechanisms.

When a media module is inserted, port 1 is to the front and port 2 to the rear.

Note

Fiber-optic cable connectors are susceptible to contamination and mechanical damage to the face. Protect open connections with the supplied dust caps.



Figure 5-10 SC duplex plug with gigabit media module MM492-2LD

Fast Ethernet transfer with FOC

Data transmission at 100 Mbps is over multimode FOC or single mode FOC. In both cases, the BFOC plug on the fiber-optic cable is plugged into the BFOC socket. When using the LH module, SC duplex sockets are used as the connectors.

When a media module is inserted, the front two sockets belong to port 1 and the two back sockets to port 2. The front socket is the input and the rear socket the output socket of the respective port. Behind the labeling strip on the front of the media module, you will see the relevant symbols.

Note

Fiber-optic cable connectors are susceptible to contamination and mechanical damage to the face. Protect open connections with the supplied dust caps.







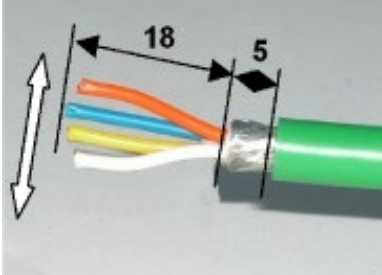
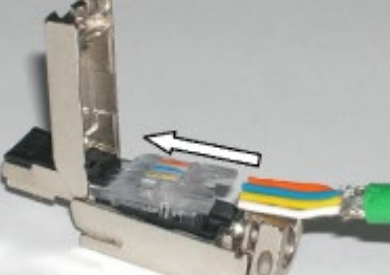
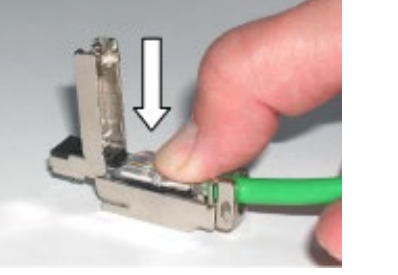

Figure 5-11 BFOC plug with Fast Ethernet media module MM491-2

5.2.6 Fitting IE FC RJ-45 Plug 180

Assembly of the IE FC RJ-45 Plug 180 on an IE FC Standard Cable

The following table lists the instructions for fitting a SIMATIC NET Industrial Ethernet FastConnect cable to the industrial IE FC RJ-45 Plug 180.

		
<p>1. In the stripping tool, use the green knife cassette 6GK1901-1GB01 (5.1 mm knife distance)!</p> <p>When using stripping tool supplied with the yellow knife cassette, the cutting depth must be adjusted with the middle socket head screw after replacing the knife cassette.</p>	<p>2. Take the stripping tool in your right hand.</p> <p>3. Measure the cable length by placing the cable on the template. Use the index finger of your left hand as the limit stop.</p>	<p>4. Place the cable in the stripping tool. The index finger of your left hand is the limit stop.</p> <p>5. Clamp the stripping tool as far as it will go.</p>
		
<p>6. Rotate the stripping tool to strip the cable</p> <ul style="list-style-type: none"> - with PVC insulation approx. 4 times, - for PUR insulation approx. 8 times <p>in the direction of the arrow.</p>	<p>7. Keeping it closed, pull the stripping tool with jacket and remnants of the shield off the end of the cable.</p>	<p>8. If the white filler was not pulled off when you stripped the cable, remove it and the transparent protective foil manually.</p> <p>9. Cut off the dummy cores.</p>
		
<p>10. Spread out the cores according to their colors on the contact elements of the FC RJ-45 plug.</p>	<p>11. Insert the cores as far as they will go into the contact elements of the FC RJ-45 plug.</p>	<p>12. Press down the contact elements as far as the limit stop to contact the cores.</p>

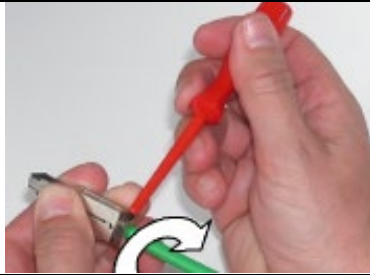
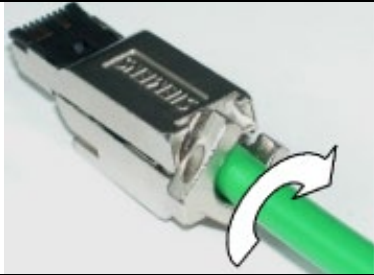

13. Close the cover and turn the locking mechanism with your hand as far as possible in the direction of the arrow.

14. Insert a 2.5 mm screwdriver into the hole in the locking mechanism and continue turning it as far as the limit stop.

15. The connector is correctly locked when the opening of the locking mechanism is at the side and the side edges are flush with the connector.

Notes:

Replace the knife cassette if the cut is not clean or after stripping approximately

- 1500 cables with a PVC outer jacket
- 150 cables with a PUR outer jacket

The insulation piercing contacts of the FC RJ-45 plug can be released and recontacted up to 10 times.

Cable ends that have had a connector fitted, must not be used twice but must be cut off before fitting a new connector.

To assemble a cable with crossed over wires, connect the color-coded wires at one end of the cable in the connector as shown below:

- Connect white with yellow
- Connect blue with orange.

Configuration / project engineering

6.1 Replacing a device

Replacing a device

Note

If you replace an IE Switch X-400, remember the following:

- Make the same settings on the DIL switches of the new SCALANCE X414-3E device as they were on the old device.
 - Install the identical media module configuration and, if applicable with the SCALANCE X414-3E, the extender module configuration on the new device as was on the old device.
 - Use the C-PLUG of the old device in the new one. This means that the previous device configuration will be adopted automatically when the new device starts up.
-

6.2 Slot numbers of the modules and covers

Specifying the slot number

The preinstalled modules, the media modules, the covers for unused slots and the dummy cover must be labeled with the slot number using the slot number tabs supplied. Since the power supply unit is not located on the basic device and has slot number 1, start with number 2 for the power module. The order for the other modules is in ascending order to the right. This applies to any extender modules that may be used on the SCALANCE X414-3E, starting from the left with number 12.

Applying the slot numbers

1. Place the required slot number in front of the module.
2. Place the tongue in the opening on the module.
3. Press the slot number into the recess on the front of the housing with your finger. The slot number breaks out of the wheel.

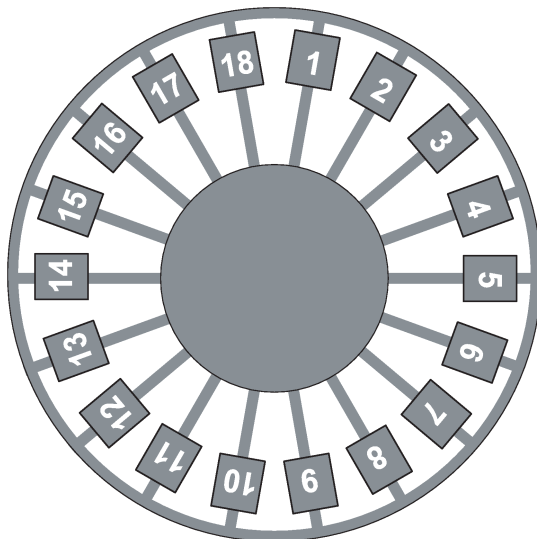

Figure 6-1 Slot number plate

6.3 Factory default

Reset

Note

Resetting the IE switch X-400 to the factory settings is described in the section "SELECT/SET button".

DIP switch (SCALANCE X414-3E only)

The four DIP switches on the CPU module are set to ON when supplied.

Note

Prior to commissioning check the switch settings.

- **RM**
is set to ON: The SCALANCE X414-3E is redundancy manager.
- **STBY**
no function.
- **R1, R2**
are set to ON: You can only configure ring redundancy with software (CLI, WBM). "Automatic Redundancy Detection" is set as the mode.

Note

With the SCALANCE X408-2 basic device no DIP switches exist. The settings for RM, SB and R1, R2 (ring ports) can be made using software. The RM can be enabled/disabled using the SELECT/SET button.

The default settings for RM and ring ports are the same for the basic devices SCALANCE X414-3E and SCALANCE X408-2.

Other device properties

R1 and R2 enable ring redundancy when the product ships.

Note

in this mode, RSTP/STP cannot be enabled.

C-PLUG

When the product ships, the C-PLUG is empty and is initialized with the factory settings the first time the device starts up. All subsequent configuration changes are adopted automatically in the internal device memory of the X-400 IE switch and on the C_PLUG.

6.4 Operator controls

6.4.1 DIL switches of the SCALANCE X414-3E

Availability

Only the SCALANCE X414-3E basic device has DIP switches.

With the SCALANCE X408-2 basic device you can make settings using software and some settings with the SELECT/SET button, refer to the section "SELECT/SET button (Page 121)".

Position

Below the labeling strip of the CPU module, on slot 4 there are the four DIP switches. These DIP switches can have two states (ON/OFF).



Figure 6-2 Power module, digital inputs and CPU module with operator controls on the SCALANCE X414-3E

Function

You can configure ring redundancy with the DIP switches:

- With the RM switch, you can configure the SCALANCE X414-3E in a ring as the redundancy manager.
- The STBY switch is reserved for a function planned for the future and is currently without function.
- With the R1 and R2 switches, you can specify the ring ports, refer also to the section "Configurable ring ports".

Changes to the switch settings during operation lead to the Fault display and to activation of the signaling contact. The settings are adopted the next time the device is restarted.

Configuration options

When the product ships, all DIP switches are set to ON.

Switch	Status	Meaning	Settings for ring ports with R1 and R2
RM	OFF	The SCALANCE X414-3E is not redundancy manager.	--
	ON	SCALANCE X414-3E is redundancy manager.	--
STBY	--	No function.	--
R1 R2	OFF OFF	The two ports on slot 5 (gigabit ports) are ring ports. Select this setting if you operate the SCALANCE X414-3E without media modules. With all other settings, ring ports are selected that are not available during operation without plugged-in media modules.	
R1 R2	ON OFF	Ports 1 and 2 of slot 6 are ring ports.	
R1 R2	OFF ON	Port 1 of slot 6 is the first ring port. Port 1 of slot 7 is the second ring port. All other ports on slots 6 and 7 can be used for optical connection of remote nodes or subnets.	

6.4 Operator controls

Switch	Status	Meaning	Settings for ring ports with R1 and R2
R1 R2	ON ON	<p>You can only configure ring redundancy with software (CLI, WBM). "Automatic Redundancy Detection" is set as the mode.</p> <p>With this setting, you cannot enable Rapid Spanning Tree / Spanning Tree.</p> <p>For more detailed information, refer to the configuration manual "SCALANCE X-300 and SCALANCE X-400 Industrial Ethernet Switches".</p>	--

Configurable ring ports

With the R1 and R2 switches, you can specify the ring ports on slots 5 to 7.

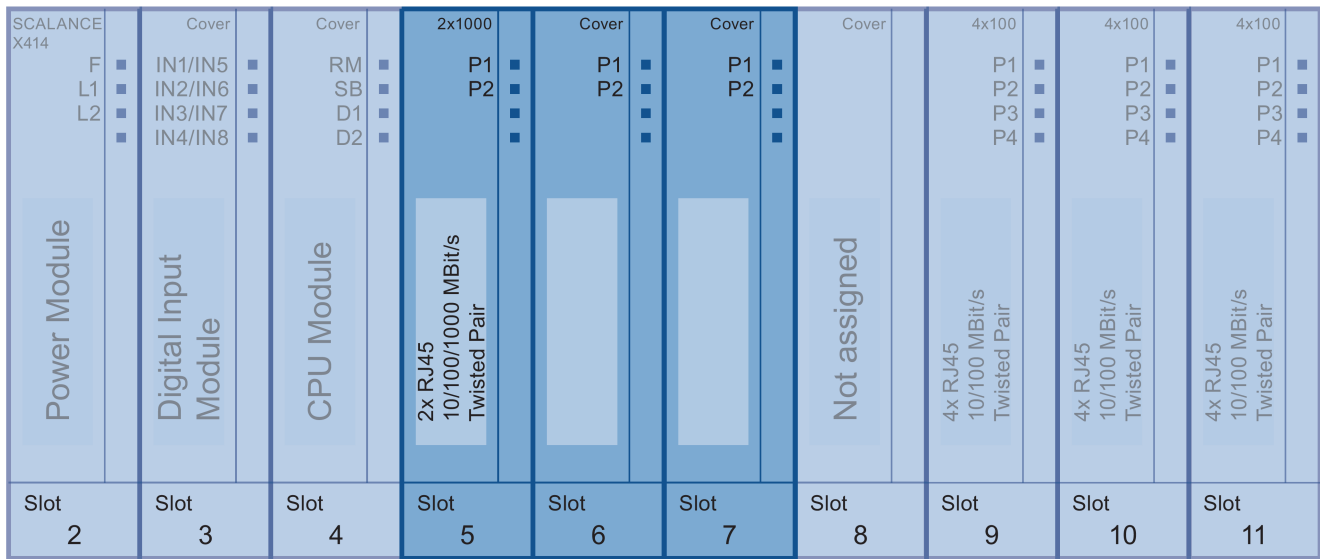



Figure 6-3 Ring ports configurable with the R1 and R2 switches

6.4.2 SELECT/SET button

 WARNING
EXPLOSION HAZARD
Do not press the SELECT/SET button when there is an explosive atmosphere.

Function

The SELECT / SET button is used to switch over the display modes (DMode) and to make other settings. After turning on the IE Switch X-400, it is in DMode A.

The button has the following functions:

- Changing the display modes
By pressing the button briefly, you change from one display mode to the next. The selected mode or current status is displayed by the LEDs (D1, D2).
- Resetting to the factory defaults
It is possible to restore some of the factory defaults in DMode A. by pressing the button for 12 seconds. You can cancel the reset procedure by releasing the button before the 12 seconds have elapsed. All previously made settings are overwritten by the factory defaults.
- Defining the fault mask and the LED displays
It is possible to set the fault mask in DMode A and DMode D. This allows you to specify the mask for signaling faults by defining an individual "good status" for the connected ports and the power supplies. In this case, you press the button for 5 seconds in DMode A or DMode D. After 3 seconds, the two LEDs (D1 and D2) start to flash. You can cancel the procedure by releasing the button before the 5 seconds have elapsed. If, however, you press the button for a further 2 seconds, the current states of all ports and the states of the power supplies L1 and L2 are included in the fault mask. The previous fault mask is then overwritten.
- Activating/deactivating the redundancy manager (only with the SCALANCE X408-2 basic device)
It is only possible to activate/deactivate the RM in DMode B by pressing the button for 5 seconds. After 3 seconds, the two LEDs (D1 and D2) start to flash. If you release the button before the 5 seconds have elapsed, the action is aborted. After 5 seconds the redundancy manager is activated/deactivated. If the redundancy manager as well as ring redundancy were deactivated, ring redundancy is also activated at the same time. If you deactivate, only the redundancy manager is deactivated.

6.5 LED display

Overview

The following table shows the states indicated by the LEDs in the various display modes. For more detailed information, refer to the subsections listed in the first column.

	LED	Display mode A	Display mode B	Display mode C	Display mode D
Power module for X414-3E and X408-2	F	Problem, signaling contact opens			
	L1	Power supply L1 is applied.			Power supply L1 is monitored
	L2	Power supply L2 is applied.			Power supply L2 is monitored
DI module only for X414-3E	IN1/IN5	Signal at input IN1	Signal at input IN5	Signal at input IN1	Signal at input IN5
	IN2/IN6	Signal at input IN2	Signal at input IN6	Signal at input IN2	Signal at input IN6
	IN3/IN7	Signal at input IN3	Signal at input IN7	Signal at input IN3	Signal at input IN7
	IN4/IN8	Signal at input IN4	Signal at input IN8	Signal at input IN4	Signal at input IN8
CPU module for X414-3E and X408-2	RM	Device is operating as RM			
	SB	Device operates in standby mode.			
	D1	off	on	off	on
	D2	off	off	on	on
Ports for X414-3E and X408-2	P1	Port status	Transmission rate	Half / full duplex	Fault mask
	P2				
	P3				
	P4				

6.5.1 Startup behavior of the SCALANCE X-400

Startup behavior of the IE Switch X-400

While the device is starting up, the red LED on the power module indicates the current status of the device. For more detailed information, refer to the following table:

	LED on	LED off	LED flashing
During device startup	Device starts or a fault/error was detected	Device startup successful	Error in keyboard input over serial interface or bad firmware image
During operation	Fault/error detected	Operation not OK	

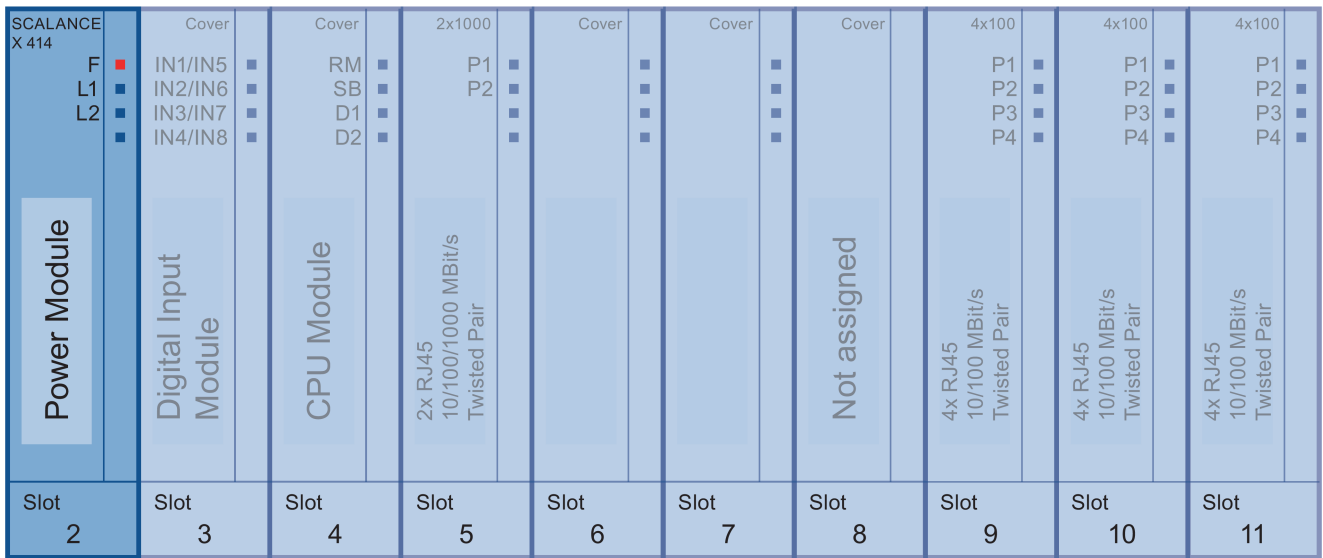

Figure 6-4 Error LED on the power module

6.5.2 Selecting the display modes

Selecting the display modes

Press the SELECT / SET button on the CPU module until the D1 and D2 light up on the CPU in the required combination. The selected display mode is then activated.

There is an automatic switchover to Dmode A if the button is not pressed for longer than one minute.

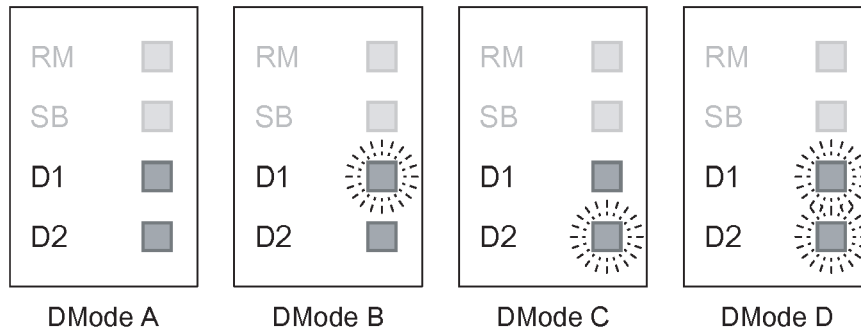

Figure 6-5 Displaying the four possible display modes

6.5.3 LED display - power module

Display modes A through C

In display modes A through C, the two LEDs D1 and D2 of the CPU module are lit as described in the section "Selecting the display modes". In these three states, the status of the signaling contact and the presence of the supply voltages are displayed by the LEDs of the power module.

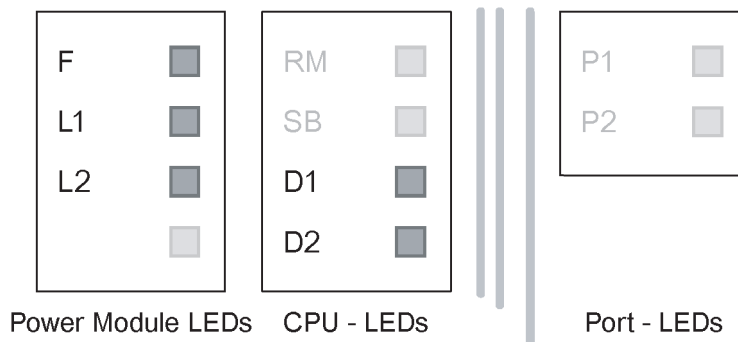

Figure 6-6 Example of the LED display of the power module and the CPU module in DMode A

The following table lists the significance of the three LEDs on the power module for display modes A through C:

Label	Color	Status	Meaning
F		off	The IE Switch X-400 has not detected any faults, the signaling contact is closed.
	Red	on	The IE Switch X-400 has detected a fault, the signaling contact opens.
L1		off	Power supply L1 lower than 17 V.
	Green	on	Power supply L1 higher than 17 V.
L2		off	Power supply L2 lower than 17 V.
	Green	on	Power supply L2 higher than 17 V.

Display in display mode D

In display mode D, both the D1 and D2 LEDs of the CPU module are on. This mode indicates whether the power supply is being monitored with the signaling contact.

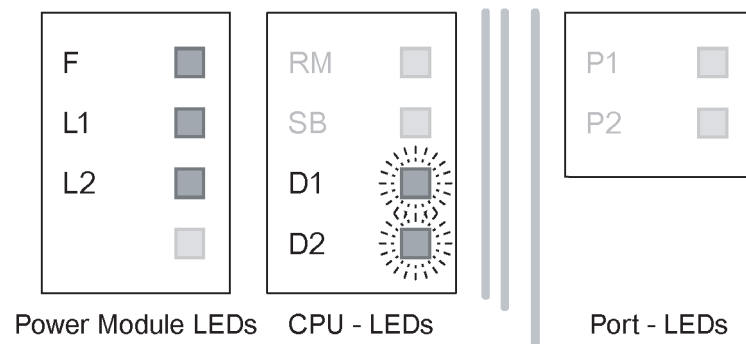

Figure 6-7 LED display of the power module and the CPU module in DMode D

The following table shows the meaning of the three light emitting diodes on the power module in display mode D:

Label	Color	Status	Meaning
F		off	No problem has been detected by the IE Switch X-400.
	Red	on	The IE Switch X-400 detects a fault. The signaling contact opens.
L1		off	Power supply L1 is not monitored. If L1 falls below 17 V, the signaling contact does not respond.
	Green	on	Power supply L1 is monitored. If L1 falls below 17 V, the signaling contact responds.
L2		off	Power supply L2 is not monitored. If L2 falls below 17 V, the signaling contact does not respond.
	Green	on	Power supply L2 is monitored. If L2 falls below 17 V, the signaling contact responds.

6.5.4 LED display - CPU module

CPU module

On the SCALANCE X414-3E, the LEDs of the CPU module are on slot 4; on the SCALANCE X408-2, they are on slot 3.

Display modes A through D

The set display modes are indicated as follows:

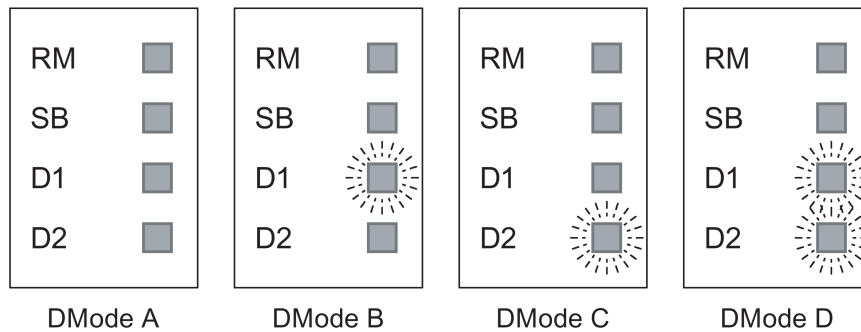

Figure 6-8 Display of the possible display modes (DMode A through DMode D)

The individual functions (RM, SB and D1/D2) are independent of each other. The LED displays are described below:

Label	Color	Status	Meaning
RM		off	The IE Switch X-400 is not operating in redundancy manager mode.
	Green	on	The IE Switch X-400 is operating in redundancy manager mode. The ring is working without problems, monitoring is activated.
		flashes	The IE Switch X-400 is operating in redundancy manager mode. An interruption has been detected on the ring; the IE Switch - 400 has switched through.
SB		off	The standby function is disabled.
	Green	on	The standby function is enabled and the standby ports are disabled.
		flashes	The standby function is enabled and the standby ports are enabled; in other words, the send and receive frames.
D1	Green	on	
D2	Green	on	

6.5.5 LED display of the ports (DMode A through DMode D)

LEDs of the ports

The two LEDs of slot 5 or the four LEDs of slots 9 through 11 of the basic device indicate various port statuses depending on the set display modes. The displays have the same significance for all ports on all slots of the basic device and the extender modules EM495-8 and EM496-4.

Port statuses in DMode A

In display mode A, the current port status is displayed.

Port	Color	Status	Meaning
P1 P2 P3 P4		off	No valid link to the port (for example station turned off or cable not connected)
	Green	on	Link exists and port in normal status. In this status, the port can receive and send data.
		flashes once per period	Link exists and port in "blocking" status. In this status, the port only receives management data (no user data).
		flashes three times per period	Link exists and port turned off by management. In this status, no data is sent or received over the port.
		flashes four times per period	Port exists and is in the "monitored port" status. In this status, the data traffic of another port is copied to this port.
	Yellow	flashes / lit	Link exists, port is in normal status and data is being received at the port.

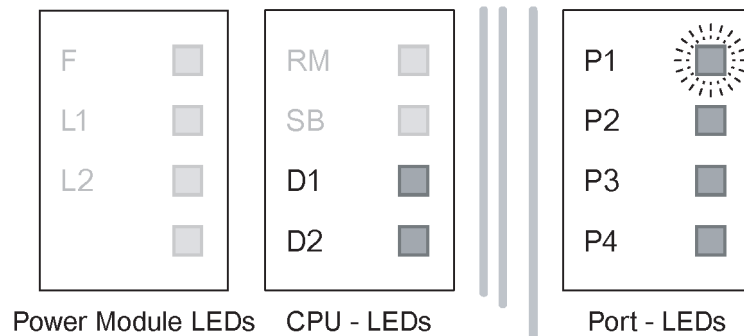

Figure 6-9 Display of the port status of port 1

Port statuses in DMode B

In display mode B, the current transmission rate is displayed.

Port	Color	Status	Meaning
P1		off	Port operating at 10 Mbps
P2 P3	Green	on	Port operating at 100 Mbps
P4	Yellow	on	Port operating at 1000 Mbps

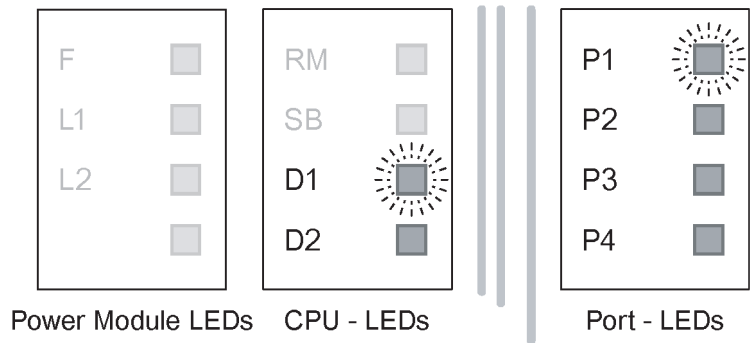

Figure 6-10 Display of the transmission speed of port 1

Note

If there is a link fault and the type of transmission is fixed (autonegotiation off), in DMode B, the desired status, in other words the set transmission rate (1000 Mbps, 100 Mbps, 10 Mbps) continues to be displayed. If there is a link fault and autonegotiation is active, the port LED goes off.

Port statuses in DMode C

In display mode C, the current mode (half duplex, full duplex) is indicated.

Port	Color	Status	Meaning
P1		off	Port operating in half duplex
P2 P3 P4	Green	on	Port operating in full duplex

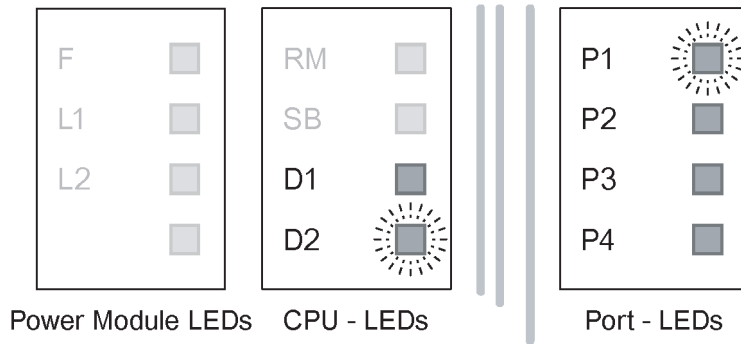

Figure 6-11 Mode display (full, half duplex) of port 1

Note

If there is a link fault and the type of transmission is fixed (autonegotiation off), in DMode C, the desired status, in other words the set type of transmission (full or half duplex) continues to be displayed. If there is a link fault and autonegotiation is active, the port LED goes off.

Port statuses in DMode D

In display mode D, you can see whether or not the port is monitored.

Port	Color	Status	Meaning
P1 P2		off	The port is not monitored; in other words, if a link is not established at the port, this does not trigger the signaling contact.
P3 P4	Green	on	Port is monitored; in other words, if there is no link established at the port (for example cable not plugged in or connected device turned off), this triggers the signaling contact and the fault state is adopted.

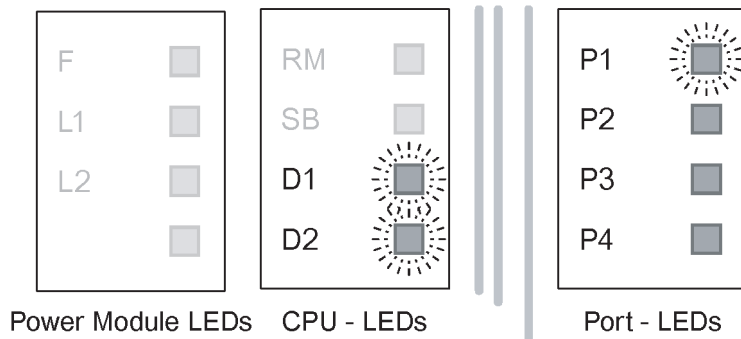

Figure 6-12 Example: Monitoring of port 1 is "on"

6.6 Replacing the C-PLUG

Removing the C-PLUG

It is only necessary to remove the C-PLUG if there is a problem on the basic device. After removing the labeling strip, the upper part of the C-PLUG can be carefully levered out of the CPU module using a slotted screwdriver until it can be gripped with your fingers and completely removed.

Note

The C-PLUG must only be removed or inserted when the power supply to the device is turned off.

Inserting in the C-PLUG slot

The C-PLUG of the SCALANCE X414-3E is located on the front of the CPU module below the labeling strip. The C-PLUG of the SCALANCE X408-2 on the power module. After removing the labeling strip, the C-PLUG is inserted in the receptacle with the socket connector leading. The notch in the casing must be on the right. The C-PLUG is inserted by pressing it into the receptacle until the C-PLUG is flush with the front surface of the CPU.



Figure 6-13 Removing the C-PLUG from the SCALANCE X414-3E

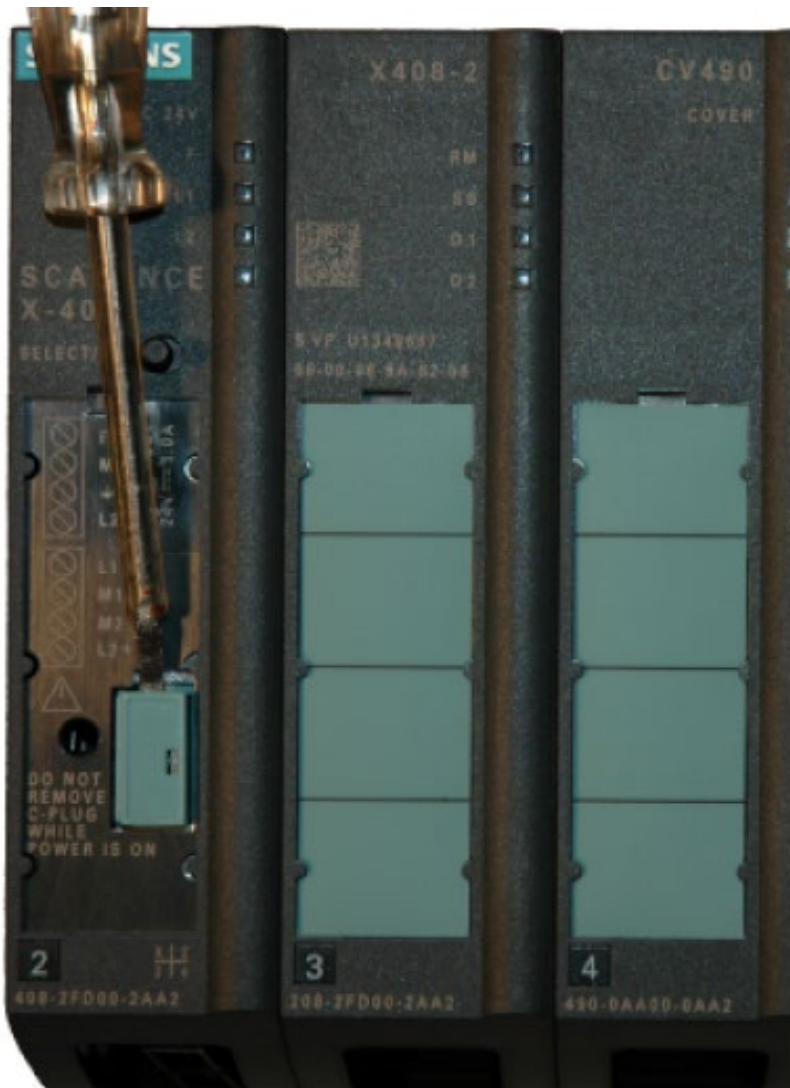

Figure 6-14 Removing the C-PLUG from the SCALANCE X408-2

6.7 Show Location

Localizing an IE Switches X-400

To identify an IE Switch X-400 locally and with certainty, you can use the "show location" function on a programming device to select the node over the network and make it flash. This can be used, for example, when assigning addresses to make sure that the correct node receives the address. All port LEDs of the addressed node flash green at 2 Hz.

With the PST Tool V3.0, you can trigger this function with "Module \ Ring".

Approvals

The SIMATIC NET products described in these Operating Instructions have the approvals listed below.

Note

Issued approvals on the type plate of the device

The specified approvals apply only when the corresponding mark is printed on the product. You can check which of the following approvals have been granted for your product by the markings on the type plate.

Machinery directive

The product remains a component in compliance with Article 4 (2) of the EC Machinery Directive 89/392/EEC.

According to the machinery directive, we are obliged to point out that the product described is intended solely for installation in a machine.

Before the final product can be put into operation, it must be tested to ensure that it conforms with the directive 89/392/EEC.

Note for the manufacturers of machines

This product is not a machine in the sense of the EC Machinery Directive. There is therefore no declaration of conformity relating to the EC Machinery Directive 89/392/EEC for this product.

EC directives

SIMATIC NET products meet the requirements and aims of the following EC directives.

EMC directive (electromagnetic compatibility)

The SIMATIC NET products described in these operating instructions meet the requirements of EC directive 2004/108/EC "Electromagnetic Compatibility" for the following areas of application:

Field of application	Requirements	
	Emission	Immunity to interference
Industry	EN 61000-6-4 : 2007	EN 61000-6-2 : 2005

EU declaration of conformity

You will find EC declaration of conformity for these products on the Internet pages of Siemens Industry Online Support (<http://support.automation.siemens.com/WW/view/en/33118389/134200>).

 **WARNING**

Personal injury and property damage can occur

The installation of expansions that are not approved for SIMATIC NET products or their target systems may violate the requirements and regulations for safety and electromagnetic compatibility.

Only use expansions that are approved for the system.

- **Keep to the installation guidelines**
The devices meet the requirements if you adhere to the installation and safety instructions contained in this documentation and in the following documentation when installing and operating the devices.
- **You can always find the latest documentation on the Internet**
The current descriptions of the currently available products can always be found on the Internet under the specified entry IDs/Internet pages:
 - "Industrial Ethernet / PROFINET Industrial Ethernet" System Manual
 - "Industrial Ethernet / PROFINET - Passive network components" System Manual
You will find information on the system manuals in the section "Preface X400 (Page 7)", in "Further documentation".
 - "EMC Installation Guidelines" configuration manual
ID = 60612658 (<http://support.automation.siemens.com/WW/view/en/60612658>)
- **Working on the device**
To protect the device from electrostatic discharge, personnel must first discharge any electrostatic charge from their body before touching the device.

Note

The test was performed with a device and a connected communications partner that also meets the requirements of the standards listed above.

When operating the device with a communications partner that does not comply with these standards, adherence to the corresponding values cannot be guaranteed.

ATEX (explosion protection directive)

 WARNING
<p>When using SIMATIC NET products in hazardous area zone 2, make absolutely sure that the associated conditions in the following document are adhered to:</p> <p>"SIMATIC NET Product Information Use of subassemblies/modules in a Zone 2 Hazardous Area".</p> <p>You will find this document</p> <ul style="list-style-type: none"> • on the data medium that ships with some devices. • on the Internet pages of Siemens Industry Online Support (http://support.automation.siemens.com/WW/view/en). <p>Enter the document identification number C234 as the search term.</p>

SIMATIC NET products meet the requirements of the EC directive:94/9/EC "Equipment and Protective Devices for Use in Potentially Explosive Atmospheres".

ATEX classification:

II 3 G Ex nA IIC T4 Gc

KEMA 07ATEX0145 X

The products meet the requirements of the following standards:

- EN 60079-15 (electrical apparatus for potentially explosive atmospheres; Type of protection "n")
- EN 60079-0 (Explosive atmospheres - Part 0: Equipment - General requirements)

You will find the current versions of the standards in the currently valid ATEX certificates.

ATEX (explosion protection directive) - optical radiation

 WARNING
<p>When using SIMATIC NET products in hazardous area zone 2, make absolutely sure that the associated conditions in the following document are adhered to:</p> <p>"SIMATIC NET Product Information Use of subassemblies/modules in a Zone 2 Hazardous Area".</p> <p>You will find this document</p> <ul style="list-style-type: none"> • on the data medium that ships with some devices. • on the Internet pages of Siemens Industry Online Support (http://support.automation.siemens.com/WW/view/en). <p>Enter the document identification number C234 as the search term.</p>

SIMATIC NET products meet the requirements of the EC directive:94/9/EC "Equipment and Protective Devices for Use in Potentially Explosive Atmospheres".

ATEX classification:

II 3 (2) G Ex nA [op is] IIC T4 Gc

DEKRA 11ATEX0060 X

The products meet the requirements of the following standards:

- EN 60079-0
- EN 60079-15
- EN 60079-28

You will find the current versions of the standards in the currently valid ATEX certificates.

IECEX

The SIMATIC NET products meet the requirements of explosion protection according to IECEX.

IECEX classification:

Ex nA IIC T4 Gc

DEK 14.0025X

The products meet the requirements of the following standards:

- IEC 60079-15 (Explosive atmospheres - Part 15: Equipment protection by type of protection "n")
- IEC 60079-0 (Explosive atmospheres - Part 0: Equipment - General requirements)

You will find the current versions of the standards in the currently valid IECEX certificates.

IECEX (optical radiation)

The SIMATIC NET products meet the requirements of explosion protection according to IECEX.

IECEX classification:

Ex nA [op is Gb] IIC T4 Gc

DEK 14.0026X

The products meet the requirements of the following standards:

- IEC 60079-15 (Explosive atmospheres - Part 15: Equipment protection by type of protection "n")
- IEC 60079-0 (Explosive atmospheres - Part 0: Equipment - General requirements)
- IEC 60079-28 (Explosive atmospheres - Part 28: Protection of equipment and transmission systems using with optical radiation)

You will find the current versions of the standards in the currently valid IECEX certificates.

FM

The product meets the requirements of the standards:

- Factory Mutual Approval Standard Class Number 3611
- FM Hazardous (Classified) Location Electrical Equipment:
Non Incendive / Class I / Division 2 / Groups A,B,C,D / T4 and
Non Incendive / Class I / Zone 2 / Group IIC / T4

cULus approval for industrial control equipment

cULus Listed IND. CONT. EQ.

Underwriters Laboratories Inc. complying with

- UL 508
- CSA C22.2 No. 142-M1987

Report no. E85972

cULus Approval for Information Technology Equipment

cULus Listed I. T. E.

Underwriters Laboratories Inc. complying with

- UL 60950-1 (Information Technology Equipment)
- CSA C22.2 No. 60950-1-03

Report no. E115352

cULus Approval Hazardous Location

cULus Listed I. T. E. FOR HAZ. LOC. Underwriters Laboratories Inc. complying with

- UL 60950-1 (Information Technology Equipment)
- ANSI/ISA 12.12.01
- CSA C22.2 No. 60950-1-03
- CSA C22.2.No. 213-M1987

Approved for use in:

Cl. 1, Div. 2, GP. A, B, C, D, T4 A

Cl. 1, Zone 2, GP. IIC T4

Cl. 1, Zone 2, Aex nC IIC T4

Report no. E240480

RCM

The product meets the requirements of the AS/NZS 2064 standard (Class A).

KC (Korean Standard)

The products meet the requirements of the "Korean Standard".

Marking for the customs union



EAC (Eurasian Conformity)

Customs union of Russia, Belarus and Kazakhstan

Declaration of the conformity according to the technical regulations of the customs union (TR CU)

FDA and IEC approvals

- No FDA or IEC mark is necessary for the MM491-2 media module.

The following media modules meet the FDA and IEC requirements listed below:

- MM491-2LD
- MM491-2LH+
- MM492-2
- MM492-2LD
- MM492-2LH
- MM492-2LH+
- MM492-2ELH



Figure 7-1 FDA and IEC approvals

CAUTION
Use of controls or adjustments or performance of procedures other than those specified herein may result in hazardous radiation exposure.

Technical specifications

8.1 SCALANCE X414-3E and X408-2 - technical specifications

Interfaces

	SCALANCE X414-3E	SCALANCE X408-2
Connecting end devices or network segments over twisted pair	2 x RJ-45 jack (10/100/1000 Mbps) 12 x RJ-45 jack (10/100 Mbps) All electrical ports support autonegotiation and autocrossover.	4 x RJ-45 jack (10/100/1000 Mbps) 4 x RJ-45 jack (10/100 Mbps) All electrical ports support autonegotiation and autocrossover.
Installation of media modules	2 x slot (6 and 7) for media module types MM491-2, MM491-2LD and MM491-2LH+ 1 x slot (5) for media module types MM492-2, MM492-2LD, MM492-2LH, MM492-2LH+ and MM492-2ELH	2 x universal slot for media module types MM491-2 or MM491-2LD or MM491-2LH+ or MM492-2 or MM492-2LD or MM492-2LH or MM492-2LH+ or MM492-2ELH
Installation of extender modules	1 x slot for extender module EM495-8 or EM496-4	Not present.
Connector for power supply and signaling contact	2 x 4-pin plug-in terminal blocks	2 x 4-pin plug-in terminal blocks
Connection of digital inputs	2 x 5-pin plug-in terminal blocks	Not present.
Power supply (redundant inputs isolated)	2 power supplies 24 V DC (20.4 to 28.8 V) safety extra-low voltage (SELV) Permitted voltage range incl. total ripple: 18.5 VDC - 30.2 VDC Power supply voltage connected over high resistance with housing (not electrically isolated). Tested to IEC 6100-4-5, 1995 "Surge Immunity Test", performed with lightning protection device DEHN Blitzductor VT AD 24 V, article no. 918 402	2 power supplies 24 V DC (20.4 to 28.8 V) safety extra-low voltage (SELV) Permitted voltage range incl. total ripple: 18.5 VDC - 30.2 VDC Power supply voltage connected over high resistance with housing (not electrically isolated). Tested to IEC 6100-4-5, 1995 "Surge Immunity Test", performed with lightning protection device DEHN Blitzductor VT AD 24 V, article no. 918 402
Power consumption (without modules) at 24 V DC	15 W	8 W

8.1 SCALANCE X414-3E and X408-2 - technical specifications

	SCALANCE X414-3E	SCALANCE X408-2
Current consumption at 24 V DC	< 2000 mA	< 700 mA
Load on the signaling contact	24 V DC / max. 100 mA safety extra-low voltage (SELV)	24 V DC / max. 100 mA safety extra-low voltage (SELV)
Overvoltage protection at input	Non-replaceable fuse (F 3.15 A / 250 V)	Non-replaceable fuse (F 3 A / 32 V)
Digital Inputs	Input voltage: <ul style="list-style-type: none"> • Rated value 24 V DC safety extra-low voltage (SELV) • For state "1": + 13 V ...+ 30 V • For state "0": – 30 V to + 3 V Max. input current: 8 mA Max. cable length: 30 m Inputs isolated from electronics.	Inputs not present.

C-PLUG

	SCALANCE X414-3E	SCALANCE X408-2
Dimensions (width x height x depth)	24.3 x 17.0 x 8.1 mm	24.3 x 17.0 x 8.1 mm
Weight	approx. 5 g	approx. 5 g
Power consumption	0.015 W	0.015 W
Memory capacity	32 Mbytes	32 Mbytes

Permitted cable lengths

	SCALANCE X414-3E	SCALANCE X408-2
TP cable length	With TP cord up to 10 m, with FastConnect cabling system up to 100 m.	With TP cord up to 10 m, with FastConnect cabling system up to 100 m.

Redundancy reconfiguration times

Redundancy	Reconfiguration times
HRP	300 ms
Standby link	300 ms
MRP	200 ms

Cascading depth

	SCALANCE X414-3E	SCALANCE X408-2
Linear/star structure	Any (only depending on signal propagation time)	Any (only depending on signal propagation time)
Ring with redundancy manager in HRP mode	50 (for reconfiguration time < 0.3 seconds)	50 (for reconfiguration time < 0.3 seconds)

Switching properties

	SCALANCE X414-3E	SCALANCE X408-2
Max. number of learnable addresses	8000	8000
Aging time (default)	40 s	40 s
Switching technique	Store and forward	Store and forward
Latency (store and forward time)	5 μ s	5 μ s (10 μ s when changing from gigabit to Fast Ethernet or vice versa)

Full wire speed switching

Number of frames		At a frame length of (in bytes):
at 100 Mbps	at 1000 Mbps	
148810	1488095	64
84459	844595	128
45290	452899	256
23496	234962	512
11973	119732	1024
9615	96154	1280
8127	81274	1518

Note

The IE Switches X-400 support full wire speed switching complying with IEEE 802.3 on all ports.

The number of packets depends on the packet length according to the IEEE802.3 standard.

Permitted environmental conditions / EMC

	SCALANCE X414-3E	SCALANCE X408-2
Operating temperature	Product version for 01 to 06 0°C to + 60°C Product version as of 07 -40°C to + 70°C	0°C through + 60°C
Storage/transport temperature	- 40°C through + 80°C	- 40°C through + 80°C
Relative humidity in operation	< 95% (no condensation)	< 95% (no condensation)
Operating altitude	Max. 2000 m	Max. 2000 m
RF interference level	EN 55081 Class A	EN 55081 Class A
Immunity	EN 61000-6-2 : 2001	EN 61000-6-2 : 2001

Construction

	SCALANCE X414-3E	SCALANCE X408-2
Dimensions (W x H x D)	344 x 145 x 117 mm	242 x 145 x 117 mm
Weight	3,070 g	1,900 g
Installation options	35 mm DIN rail S7-300 standard rail	35 mm DIN rail S7-300 standard rail
Degree of protection	IP20	IP20

MTBF information (mean time between failure)

Device type	MTBF
SCALANCE X414-3E basic device 6GK5 414-3FC00-2AA2	24 years
SCALANCE X414-3 basic device 6GK5 414-3FC10-2AA2	24 years
SCALANCE X408-2 basic device 6GK5 408-2FD00-2AA2	18 years
Twisted pair extender EM495-8 6GK5 495-8BA00-8AA2	1,474 years
Media module extender EM496-4 6GK5 496-4MA00-8AA2	2,038 years
Fast Ethernet media module MM491-2 6GK5 491-2AB00-8AA2	138 years
Fast Ethernet media module MM491-2LD 6GK5 491-2AC00-8AA2	141 years
Fast Ethernet media module MM491-2LH+ 6GK5 491-2AE00-8AA2	125 years
Gigabit media module MM492-2 6GK5 492-2AL00-8AA2	400 years
Gigabit media module MM492-2LD 6GK5 492-2AM00-8AA2	400 years

8.1 SCALANCE X414-3E and X408-2 - technical specifications

Device type	MTBF
Gigabit media module MM492-2LH 6GK5 492-2AN00-8AA2	400 years
Gigabit media module MM492-2LH+ 6GK5 492-2AP00-8AA2	400 years

8.2 Media module MM491-2 (100Base-FX) - technical specifications

Interface

Connection of end devices or network segments over FOC	2x2 BFOC sockets (100 Mbps, 100BaseFX, full duplex)
Diode power	< -14 dBm
Power consumption	
<ul style="list-style-type: none"> For product versions 01 to 04 As of product version 05 	2 W 4 W

Permitted cable lengths

FO cable lengths: <ul style="list-style-type: none"> 50/125 µm multimode fiber 	0 – 3 km (1 dB/km at 1310 nm; 1200 MHz*km; maximum insertion loss 0.5 dB; 4.5 dB max. permitted FO cable attenuation at 3 dB link power margin)
---	---

Permitted environmental conditions / EMC

Operating temperature <ul style="list-style-type: none"> For product versions 01 to 04 As of product version 05 	0 °C through + 60 °C -40 °C through + 70 °C
Storage/transport temperature	- 40°C through + 80°C
Relative humidity in operation	< 95% (no condensation)
Operating altitude	Max. 2000 m
RF interference level	EN 55081 Class A
Immunity	EN 61000-6-2: 2001

Construction

Dimensions (W x H x D)	35 x 145 x 90 mm
Weight	260 g
Degree of protection	IP20

8.3 Media module MM491-2LD (100Base-FX) - technical specifications

Interfaces

Connection of end devices or network segments over FOC	2x2 BFOC sockets (100 Mbps, 100BaseFX, full duplex)
Power of the laser diode	< -8 dBm
Power consumption <ul style="list-style-type: none"> For product versions 01 to 04 As of product version 05 	2 W 4 W

Permitted cable lengths

FO cable lengths: <ul style="list-style-type: none"> 9/125 µm single mode fiber 	0 - 26 km (0.5 dB/km at 1310 nm; maximum insertion loss 0.5 dB; 14 dB max. permitted FO cable attenuation at 2 dB link power margin)
--	--

Permitted environmental conditions / EMC

Operating temperature <ul style="list-style-type: none"> For product versions 01 to 04 As of product version 05 	0 °C through + 60 °C -40 °C through + 70 °C
Storage/transport temperature	- 40°C through + 80°C
Relative humidity in operation	< 95% (no condensation)
Operating altitude	Max. 2000 m
RF interference level	EN 55081 Class A
Immunity	EN 61000-6-2: 2001
Laser protection	Class 1 complying with IEC 60825-1

Construction

Dimensions (W x H x D)	35 x 145 x 90 mm
Weight	260 g
Degree of protection	IP20

8.4 Media module MM491-2LH+ (100Base-FX) - technical specifications

Interfaces

Connection of end devices or network segments over FOC	2x SC duplex sockets (100 Mbps, 100BaseFX, full duplex)
Power of the laser diode	< 0 dBm
Power consumption	4 W

Permitted cable lengths

FO cable lengths: <ul style="list-style-type: none"> 9/125 µm single mode fiber 	0 - 70 km (0.38 dB/km at 1550 nm; maximum insertion loss 0.5 dB; 26 dB max. permitted FO cable attenuation at 3 dB link power margin minimum cable attenuation at 3 dB)
---	--

Permitted environmental conditions / EMC

Operating temperature	- 40°C through + 70°C
Storage/transport temperature	- 40°C through + 80°C
Relative humidity in operation	< 95% (no condensation)
Operating altitude	Max. 2000 m
RF interference level	EN 55081 Class A
Immunity	EN 61000-6-2: 2001
Laser protection	Class 1 complying with IEC 60825-1

Construction

Dimensions (W x H x D)	35 x 145 x 90 mm
Weight	260 g
Degree of protection	IP20

8.5 Media module MM492-2 (1000Base-SX) - technical specifications

Interfaces

Connection of end devices or network segments over FOC	2 x SC duplex sockets (1000 Mbps, 1000BaseSX, full duplex)
Power of the laser diode	< -4 dBm
Power consumption	4 W

Permitted cable lengths

FO cable lengths:	
<ul style="list-style-type: none"> 50/125 µm multimode fiber 	0 - 750 m (2.5 dB/km at 850 nm; 1200 MHz*km; maximum insertion loss 0.5 dB; 4.5 dB max. permitted FO cable attenuation at 3 dB link power margin)
<ul style="list-style-type: none"> 62.5/125 µm multimode fiber 	0 – 350 m (3.1 dB/km at 850 nm; 200 MHz*km; maximum insertion loss 0.5 dB; 4.5 dB max. permitted FO cable attenuation at 3 dB link power margin)

Environmental conditions / EMC

Operating temperature:	
<ul style="list-style-type: none"> For product versions 01 to 04 As of product version 05 	0 °C through + 60 °C - 40 °C through + 70 °C
Storage/transport temperature	- 40°C through + 80°C
Relative humidity in operation	< 95% (no condensation)
Operating altitude	Max. 2000 m
RF interference level	EN 55081 Class A
Immunity	EN 61000-6-2: 2001
Laser protection	Class 1 complying with IEC 60825-1

Construction

Dimensions (W x H x D)	35 x 145 x 90 mm
Weight	250 g
Degree of protection	IP20

8.6 Media module MM492-2LD (1000Base-LX) - technical specifications

Interfaces

Connection of end devices or network segments over FOC	2 x SC duplex sockets (1000 Mbps, 1000Base-LX, full duplex)
Power of the laser diode	< -3 dBm
Power consumption	4 W

Permitted cable lengths

FO cable lengths: <ul style="list-style-type: none"> 9/125 µm single mode fiber 	0 – 10 km (0.5 dB/km at 1310 nm; maximum insertion loss 0.5 dB; 6 dB max. permitted FO cable attenuation at 3 dB link power margin)
--	--

Environmental conditions / EMC

Operating temperature: <ul style="list-style-type: none"> For product versions 01 to 04 As of product version 05 	0 °C through + 60 °C - 40 °C through + 70 °C
Storage/transport temperature	- 40°C through + 80°C
Relative humidity in operation	< 95% (no condensation)
Operating altitude	Max. 2000 m
RF interference level	EN 55081 Class A
Immunity	EN 61000-6-2: 2001
Laser protection	Class 1 complying with IEC 60825-1

Construction

Dimensions (W x H x D)	35 x 145 x 90 mm
Weight	250 g
Degree of protection	IP20

8.7 Media module MM492-2LH (1000Base-LX) - technical specifications

Interfaces

Connection of end devices or network segments over FOC	2 x SC duplex sockets (1000 Mbps, 1000Base-LX, full duplex)
Power of the laser diode	< 0 dBm
Power consumption	4 W

Permitted cable lengths

<p>FOC lengths</p> <ul style="list-style-type: none"> 9/125 µm single mode fiber 	<p>*) – 40 km (0.4 dB/km at 1550 nm; maximum insertion loss 0.5 dB; 8 dB max. permitted FO cable attenuation at 2 dB link power margin, minimum cable attenuation 3 dB)</p>
---	---

Environmental conditions / EMC

<p>Operating temperature</p> <ul style="list-style-type: none"> For product version 01 As of product version 02 	<p>0 °C through + 60 °C - 40 °C through + 70 °C</p>
Storage/transport temperature	- 40°C through + 80°C
Relative humidity in operation	< 95% (no condensation)
Operating altitude	Max. 2000 m
RF interference level	EN 55081 Class A
Immunity	EN 61000-6-2: 2001
Laser protection	Class 1 complying with IEC 60825-1

Construction

Dimensions (W x H x D)	35 x 145 x 90 mm
Weight	250 g
Degree of protection	IP20

8.8 Media module MM492-2LH+ (1000Base-LX) - technical specifications

Interfaces

Connection of end devices or network segments over FOC	2 x SC duplex sockets (1000 Mbps, 1000Base-LX, full duplex)
Power of the laser diode	< 5 dBm
Power consumption	4 W

Permitted cable lengths

FO cable lengths: <ul style="list-style-type: none"> 9/125 µm single mode fiber 	*) – 70 km (0.28 dB/km at 1550 nm; maximum insertion loss 0.5 dB, 21 dB max. permitted FO cable attenuation at 2 dB link power margin, *) minimum cable attenuation 8 dB)
--	--

Environmental conditions / EMC

Operating temperature <ul style="list-style-type: none"> For product version 01 As of product version 02 	0 °C through + 60 °C - 40 °C through + 70 °C
Storage/transport temperature	- 40°C through + 80°C
Relative humidity in operation	< 95% (no condensation)
Operating altitude	Max. 2000 m
RF interference level	EN 55081 Class A
Immunity	EN 61000-6-2: 2001
Laser protection	Class 1 complying with IEC 60825-1

Construction

Dimensions (W x H x D)	35 x 145 x 90 mm
Weight	250 g
Degree of protection	IP20

8.9 Media module MM492-2ELH (1000Base-LX) - technical specifications

Interfaces

Connection of end devices or network segments over FOC	2 x SC duplex sockets (1000 Mbps, 1000Base-LX, full duplex)
Power of the laser diode	< 5 dBm
Power consumption	4 W

Permitted cable lengths

<p>FOC lengths</p> <ul style="list-style-type: none"> 9/125 µm single mode fiber 	<p>*) – 120 km (0.225 dB/km at 1550 nm; maximum insertion loss 0.5 dB, 27 dB max. permitted FO cable attenuation at 2 dB link power margin, minimum cable attenuation 8 dB)</p>
---	---

Environmental conditions / EMC

Operating temperature	- 40°C through + 70°C
Storage/transport temperature	- 40°C through + 80°C
Relative humidity in operation	< 95% (no condensation)
Operating altitude	Max. 2000 m
RF interference level	EN 55081 Class A
Immunity	EN 61000-6-2: 2001
Laser protection	Class 1 complying with IEC 60825-1

Construction

Dimensions (W x H x D)	35 x 145 x 90 mm
Weight	250 g
Degree of protection	IP20

8.10 Extender module EM495-8 - technical specifications

Interfaces

Connection of end devices or network segments over twisted pair	8 x RJ-45 jacks (10/100 Mbps) All electrical ports support autonegotiation and autocrossover.
Power consumption	< 0.5 W

Permitted cable lengths

TP cable length	With TP cord up to 10 m, with FastConnect cabling system up to 100 m.
-----------------	---

Permitted environmental conditions / EMC

Operating temperature:	
<ul style="list-style-type: none"> • For product versions 01 to 02 • As of product version 03 	0 °C through + 60 °C - 40 °C through + 70 °C
Storage/transport temperature	- 40°C through + 80°C
Relative humidity in operation	< 95% (no condensation)
Operating altitude	Max. 2000 m
RF interference level	EN 55081 Class A
Immunity	EN 61000-6-2: 2001

Construction

Dimensions (W x H x D)	86 x 145 x 112.4 mm
Weight	560 g
Degree of protection	IP20

8.11 Extender module EM496-4 - technical specifications

Interfaces

Installation of media modules	4 x slot for media module MM491-2, MM491-2LD, MM491-2LH+
Power consumption without media modules	< 0.1 W

Permitted environmental conditions / EMC

Operating temperature:	
<ul style="list-style-type: none"> • For product versions 01 to 02 • As of product version 03 	0 °C through + 60 °C - 40 °C through + 70 °C
Storage/transport temperature	- 40°C through + 80°C
Relative humidity in operation	< 95% (no condensation)
Operating altitude	Max. 2000 m
RF interference level	EN 55081 Class A
Immunity	EN 61000-6-2: 2001

Construction

Dimensions (W x H x D)	154 x 145 x 112.4 mm
Weight	980 g
Degree of protection	IP20

Dimension drawings

Dimension drawing X414-3E

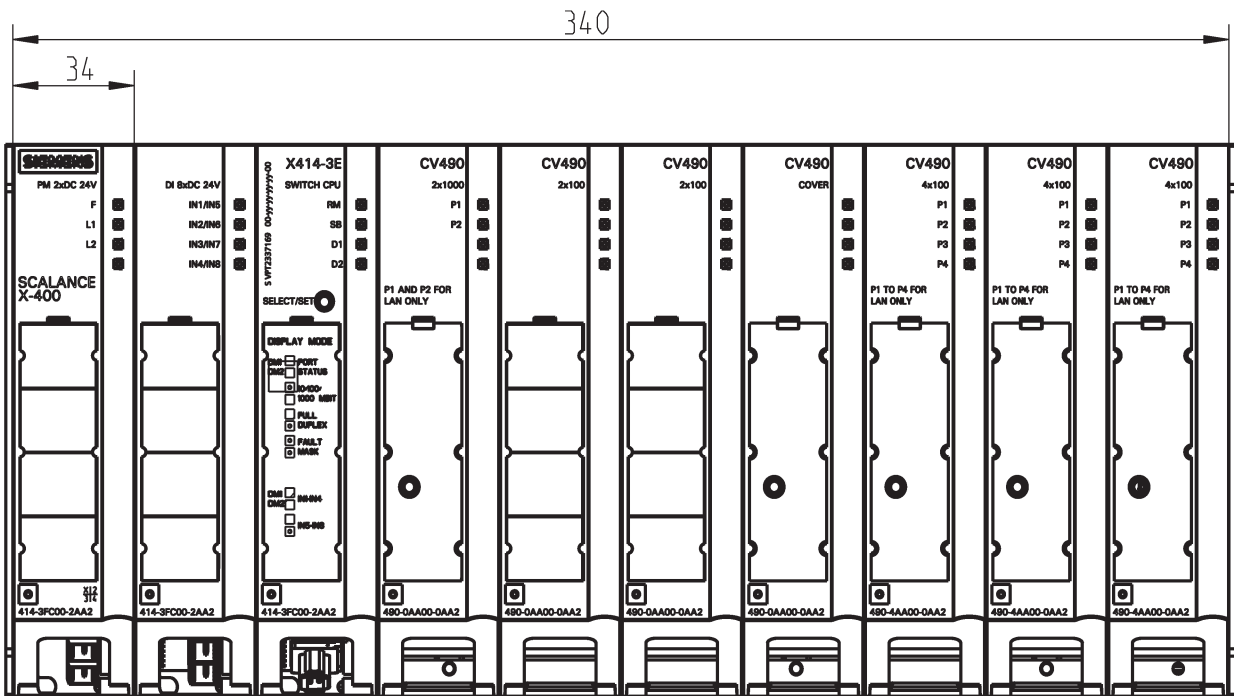

Figure 9-1 SCALANCE X414 front

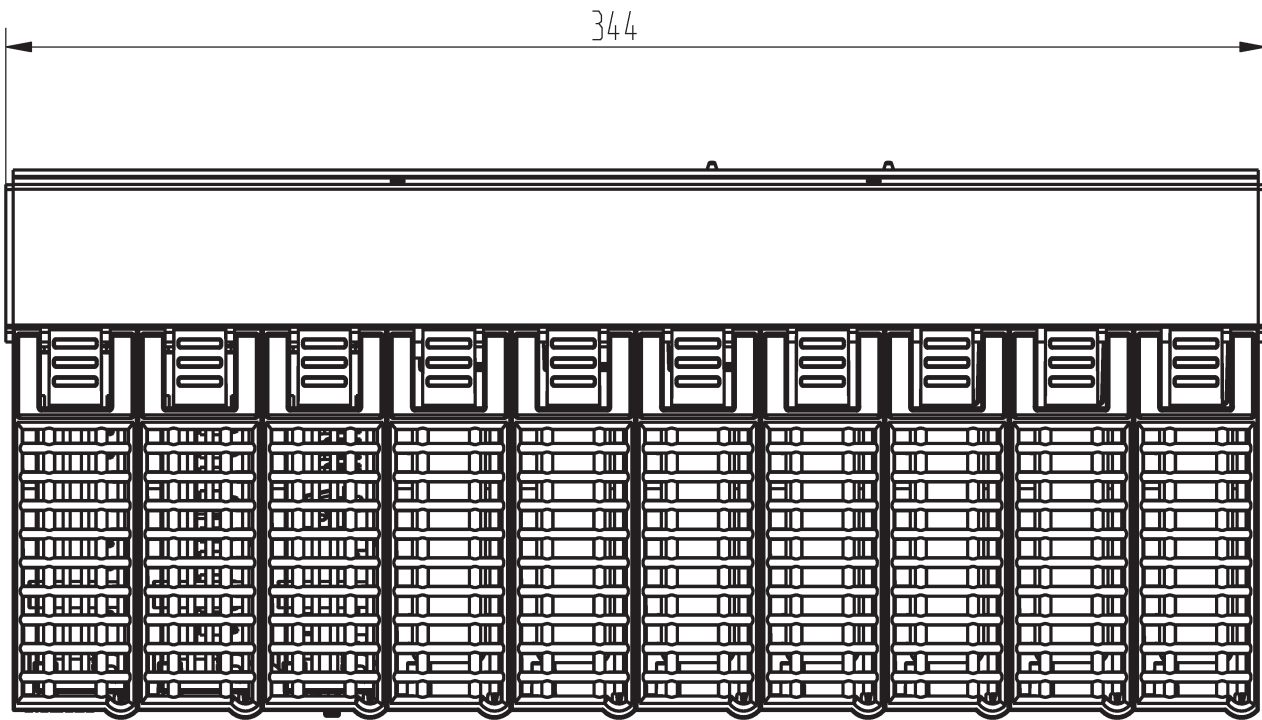

Figure 9-2 SCALANCE X414 top

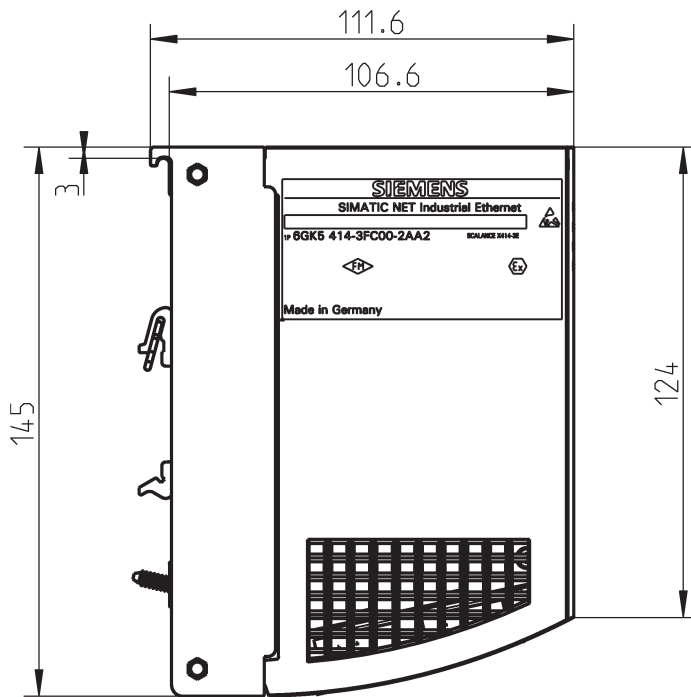

Figure 9-3 SCALANCE X414 left

Dimension drawing X408-2

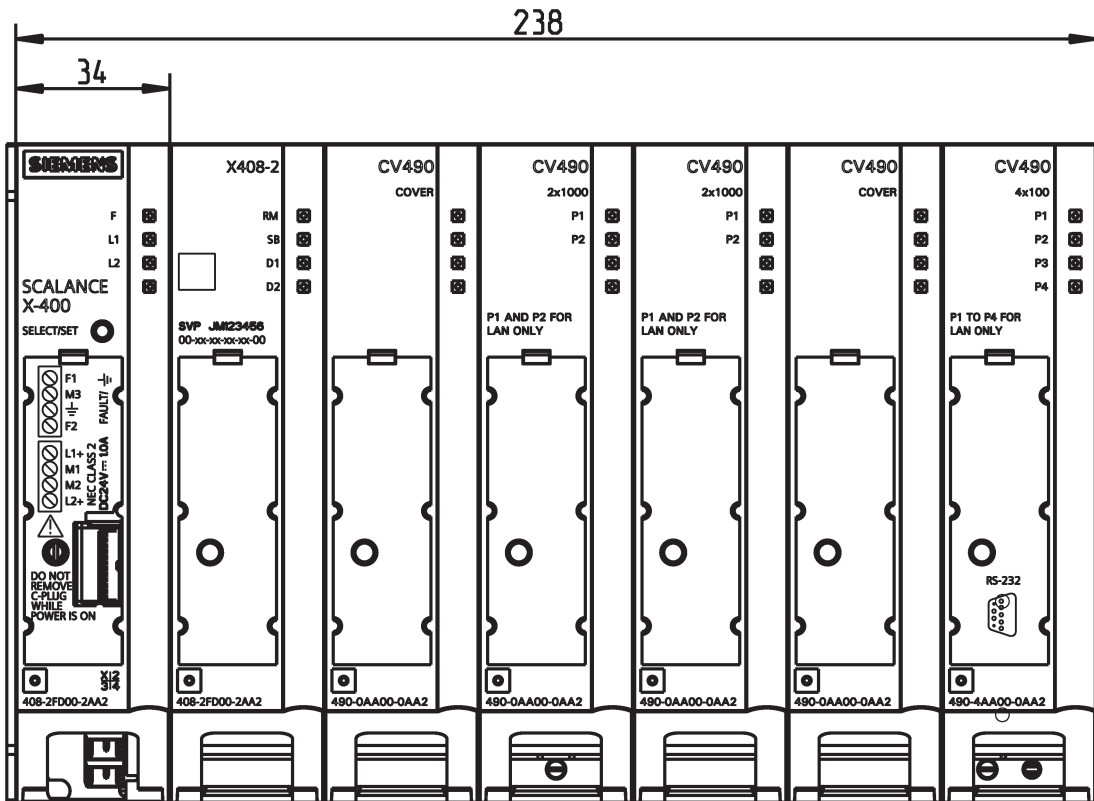

Figure 9-4 SCALANCE X408 front

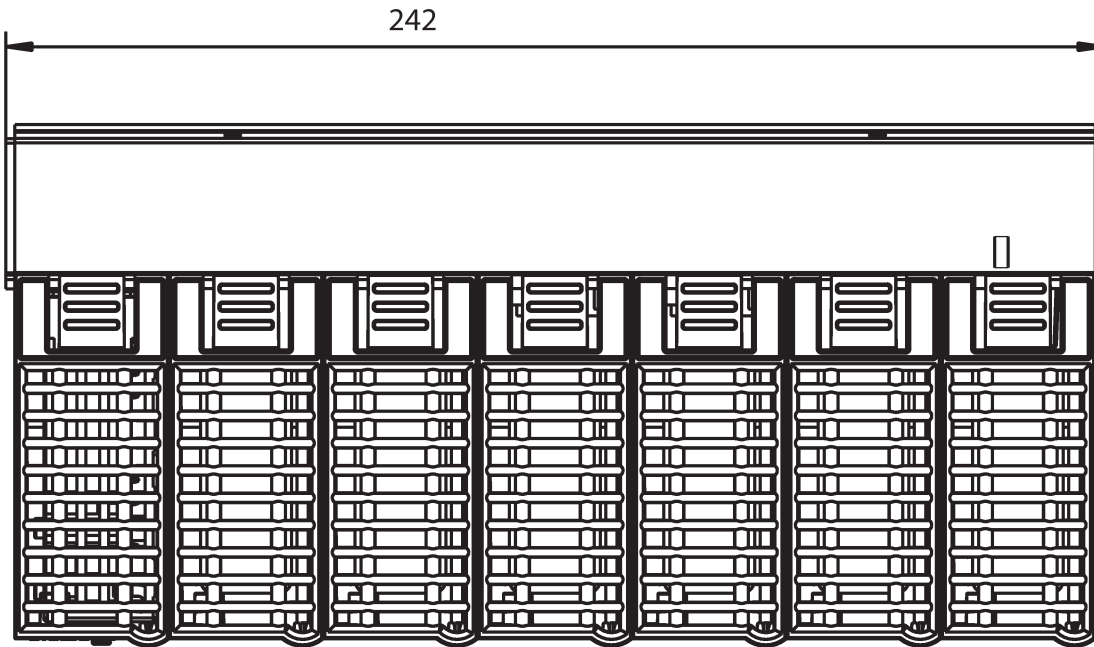

Figure 9-5 SCALANCE X408 top

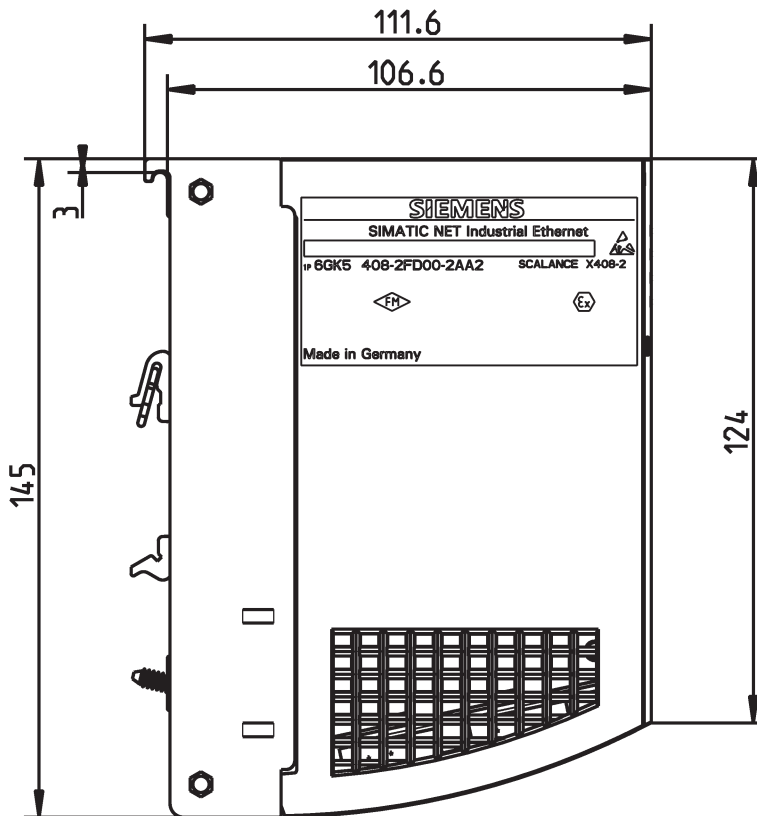

Figure 9-6 SCALANCE X408 left

Dimension drawing EM495-8

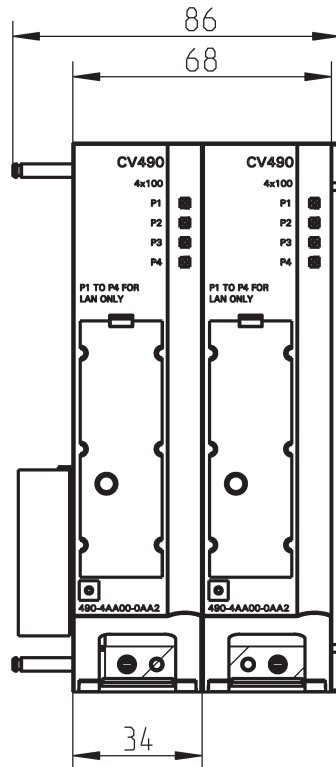

Figure 9-7 Extender module EM495-8 front

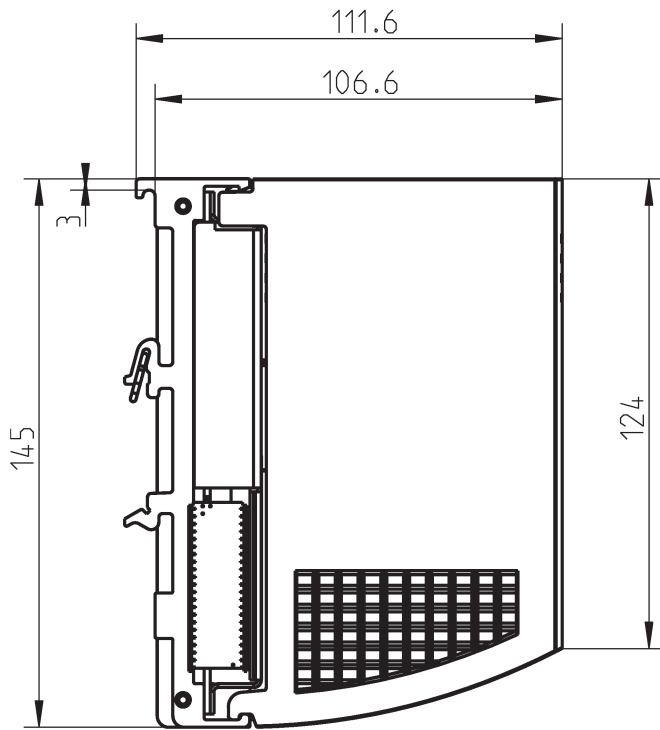

Figure 9-8 Extender module EM495-8 left

Dimension drawing EM496-4

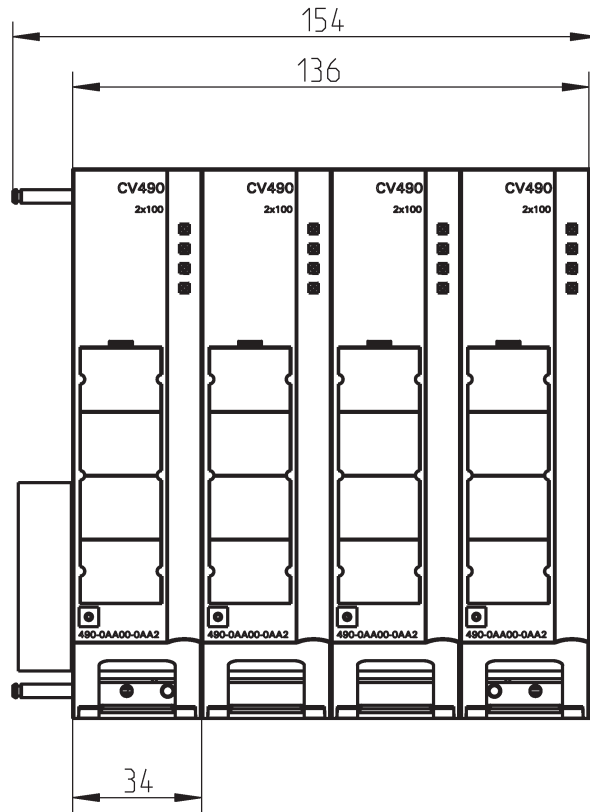

Figure 9-9 Extender module EM496-4 front

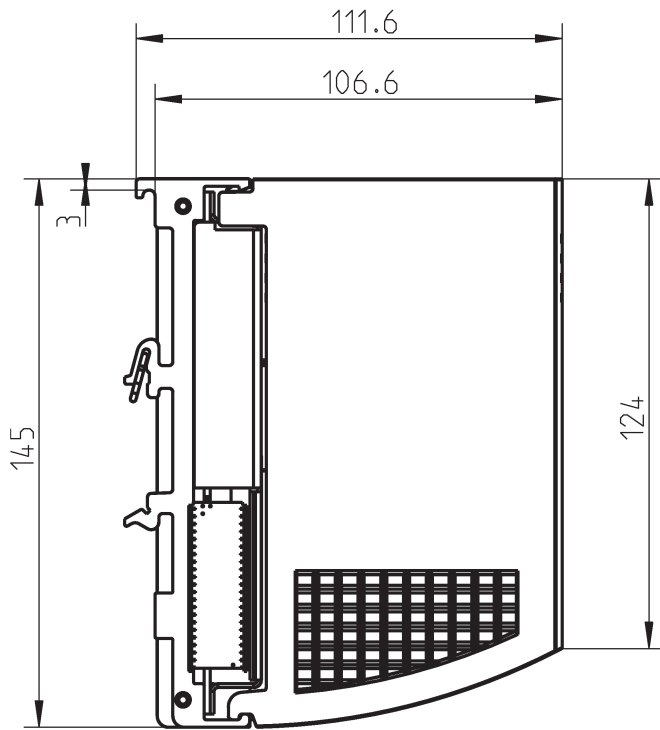

Figure 9-10 Extender module EM496-4 left

Index

A

Autonegotiation, 29

B

Basic device
SCALANCE X414-3E, 37
Basic device
SCALANCE X408-2, 45

C

Communication modes, 29
Compatibility list, 33
Components of the product
SCALANCE X408-2, 45
SCALANCE X414-3E, 36
Connectors
Digital Inputs, 104
Fiber-optic cables, 110
Power supply, 101, 101
Signaling contact, 103
Twisted pair cables, 105
Connectors
Power supply, 101, 101
Cover
SCALANCE X414-3E, 68
Covers
SCALANCE X408-2, 73
C-PLUG, 65
CPU module, 38, 41

D

DI module, 40
Dummy cover
SCALANCE X408-2, 76
SCALANCE X414-3E, 72

E

Ethernet switches, 13

Extender module

Media module extender, 63
Twisted pair extender, 61

F

Factory settings, 116
Fast Ethernet media module MM491-2, 55
Fast Ethernet media module MM491-2 LD, 56
Fast Ethernet media module MM491-2LH+, 57
Fault mask, 15

G

Gigabit media module MM492-2, 57
Gigabit media module MM492-2ELH, 60
Gigabit media module MM492-2LD, 58
Gigabit media module MM492-2LH, 59
Gigabit media module MM492-2LH+, 59
Glossary, 9

I

Installation, 81
Basic device, 80
IE FC RJ-45 Plug 180, 111
Media module, 85
Media module extender, 93
Installation
Twisted pair extender, 89

L

LED display
CPU module, 126
Power module, 125

M

Media module, 26
Media modules, 51
Multimode fiber-optic cable, 109

N

- Network topologies, 14
 - Linear structure, 14, 15
 - Redundant coupling of two network segments, 25
 - Ring with redundancy manager, 20
 - Star structure, 17
- Node localization, 132

P

- Polarity reversal protection, 101, 102
- Port status
 - DMode A, 127
 - DMode B, 128
 - DMode C, 128
 - DMode D, 129
- Ports
 - SCALANCE X408-2, 49
 - SCALANCE X414-3E, 42
- Power module, 37, 39

R

- Redundancy manager, 19
- Replacing a device, 113

S

- Safety notices
 - for installation, 77
 - general, 11
 - Use in hazardous areas, 11, 77, 99
 - when connecting up, 99
- SELECT / SET button, 121
- Selecting the display modes, 124
- Signaling contact, 39
- SIMATIC NET glossary, 9
- SIMATIC NET manual, 9
- Single mode, 14
- Single mode fiber-optic cable, 109
- Slot number, 114
- Slots
 - SCALANCE X414-3E, 37
- Startup behavior, 123
- System manual, 9, 134

T

- Transmission medium, 31
 - Multimode fiber-optic cable, 31
 - Single mode fiber-optic cable, 31
- Transmission mode, 29
 - Full duplex, 29
 - Half duplex, 29
- Transmission rate, 29

U

- Uninstalling, 83
 - Basic device, 81
 - Media module, 86
 - Media module extender, 97
 - Twisted pair extender, 92